



More Precision

eddyNCDT // Inductive sensors based on eddy currents





	Wide range of applications with more than 400 sensor models
	High temperature stability
	High resolution & linearity
	Frequency response 20 kHz (-3dB)
	Sensors for ferromagnetic and non-ferromagnetic targets
	Analog output (U/I) Digital output
	Intuitive configuration via web interface

High performance for the industry

The eddyNCDT 3060 is a powerful, inductive sensor system based on eddy currents for fast, high precision displacement measurements. The system comprises a compact controller, a sensor and an integrated cable and is factory-calibrated either for ferromagnetic or non-ferromagnetic materials.

Integration into plant and machinery

As sensor and controller are temperature-compensated, a high measurement accuracy can be achieved even in fluctuating temperatures. The sensors are designed for ambient temperatures up to a maximum of +200 °C and an ambient pressure up to 20 bar. The compact controller design as well as the sensor robustness make the measuring system ideal for integration into plant and machinery.

New benchmark in controller technology

The industrial-grade M12 Ethernet interface offers a modern fieldbus connection. Configurable analog outputs enable to output the measured values as voltage or current. For operating several systems, a new frequency separation is provided, which enables to operate several sensors next to one another without requiring any synchronization.

Features	Controller type	
	DT3060	DT3061
Active temperature compensation for sensor and controller	✓	✓
Frequency separation (LF & HF)	✓	✓
Industrial Ethernet interface	✓	✓
Intuitive web interface	✓	✓
Multipoint calibration regardless of the distance (up to 3-point calibration)	✓	✓
Scalable measuring range via analog output (teach function)	✓	✓
Scalable analog output	✓	✓
Switching and temperature outputs	-	✓
5-point calibration	-	✓
Storage of multiple characteristic curves	-	✓



When connecting a PC via the Ethernet interface, a modern web interface can be accessed without any further installation and enables the parameterization of sensor and controller. The DT3061 controller provides enhanced features such as 5-point calibration, setting of switching and temperature outputs, as well as storage of multiple characteristic curves.

Model	DT3060	DT3061
Resolution ¹⁾	static (20 Hz)	0.002 % FSO
	dynamic (20 kHz)	0.01 % FSO
Frequency response (-3dB)	selectable (20 kHz, 5 kHz, 20 Hz)	
Measuring rate	50 kSa/s	
Linearity ²⁾	< ± 0.2 % FSO	< ± 0.1 % FSO
Temperature stability	< 0.015 % FSO / K	
Temperature compensation	+10 ... +50 °C	
Synchronization	with LF & HF variants	
Target material ³⁾	Steel, aluminum	
No. of characteristic curves	1	max. 4
Supply voltage	12 ... 32 VDC	
Power consumption	2.5 W	
Digital interface	Industrial Ethernet	
Analog output	0 ... 10 V; 4 ... 20 mA (short circuit proof)	
Connection	Sensor: pluggable cable via triaxial socket; supply/signal: 8-pole M12 connector; Industrial Ethernet: 5-pole M12 connector (cable see accessories)	
Mounting	through bores	
Temperature range	Storage	-10 ... +70 °C
	Operation	0 ... +50 °C
Shock (DIN-EN 60068-2-29)	15 g / 6 ms in 3 axes, 2 directions and 1000 shocks each	
Vibration (DIN-EN 60068-2-6)	5 g / 10 ... 500 Hz in 3 axes, 2 directions and 10 cycles each	
Protection class (DIN-EN 60529)	IP67 (plugged)	
Material	die-cast aluminum	
Weight	approx. 230 g	

FSO = Full Scale Output

¹⁾ RMS noise relates to mid of measuring range

²⁾ Value with 3-/5-point linearization

³⁾ Steel: St37 steel DIN1.0037 / aluminum: AlCuMgPb3.1645

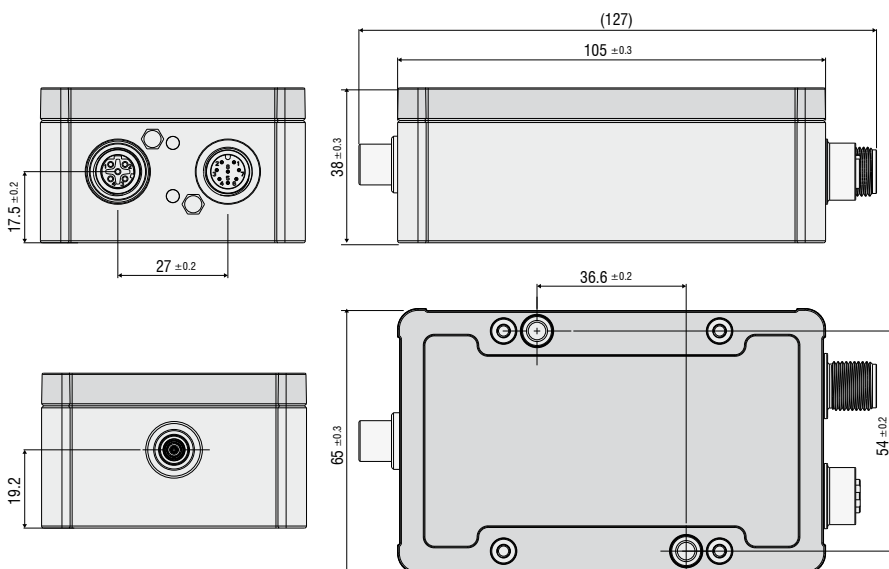

Pin assignment IN/OUT/24V IN

Pin	Assignment	Color (cable: PCx/8-M12)
1	Analog output U _{Displacement}	White
2	Supply +24 V	Brown
3	Limit value 1 / U _{Temp Sensor}	Green
4	Limit value 2 / U _{Temp Controller}	Yellow
5	GND Temperature, Limit value	Gray
6	GND analog output	Pink
7	GND supply	Blue
8	Analog output I _{Displacement}	Red

8-pole M12x1 housing connector
View on pin side

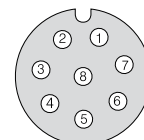

Dimensions in mm, not to scale.

▲▲▲
Measurement direction

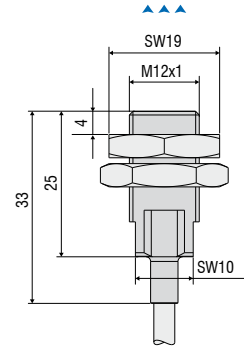
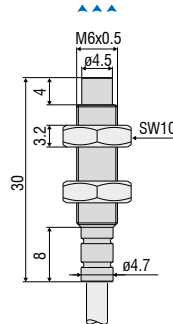

Model	ES-U1	ES-S2
Measuring range	1 mm	2 mm
Start of measuring range	0.1 mm	0.2 mm
Resolution ^{1) 2) 3)}	0.02 μm	0.04 μm
Linearity ^{1) 4)}	$< \pm 1 \mu\text{m}$	$< \pm 2 \mu\text{m}$
Temperature stability ^{1) 2)}	$< 0.15 \mu\text{m} / \text{K}$	$< 0.3 \mu\text{m} / \text{K}$
Temperature compensation	+10 ... +180 °C	+10 ... +180 °C
Min. target size (flat)	$\varnothing 18 \text{ mm}$	$\varnothing 18 \text{ mm}$
Sensor type	unshielded	shielded
Connection	integrated cable, axial, standard length 3 m; 1 m, 6 m, 9 m optional ⁵⁾	integrated cable, axial, standard length 3 m; 1 m, 6 m, 9 m optional ⁵⁾
Mounting	Cable gland (M6)	Cable gland (M12)
Temperature range	Storage	-50 ... +180 °C
	Operation	-20 ... +180 °C
Pressure resistance	20 bar (front); 5 bar (rear)	20 bar (front); 5 bar (rear)
Shock (DIN-EN 60068-2-29)	30 g	30 g
Vibration (DIN-EN 60068-2-6)	15 g	15 g
Protection class (DIN-EN 60529)	IP68 (plugged)	IP68 (plugged)
Material	stainless steel and plastic	stainless steel and plastic
Weight	2.4 g (without nuts)	11 g (without nuts)

¹⁾ Valid for operation with DT306x controller, referred to nominal measuring range

²⁾ Relates to mid of measuring range

³⁾ RMS value of the signal noise, static (20 Hz)

⁴⁾ Only with DT3061 controller and 5-point linearization

⁵⁾ Length tolerance cable: nominal value +30 %

▲▲▲▲
Measurement direction

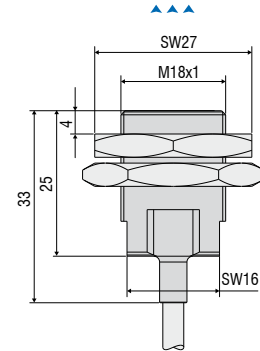
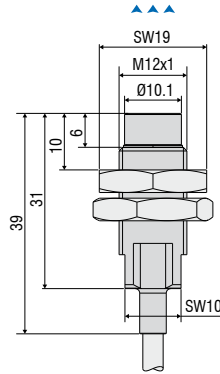

Model	ES-U3	ES-S4
Measuring range	3 mm	4 mm
Start of measuring range	0.3 mm	0.4 mm
Resolution ^{1) 2) 3)}	0.06 μm	0.08 μm
Linearity ^{1) 4)}	$< \pm 3 \mu\text{m}$	$< \pm 4 \mu\text{m}$
Temperature stability ^{1) 2)}	$< 0.45 \mu\text{m} / \text{K}$	$< 0.6 \mu\text{m} / \text{K}$
Temperature compensation	+10 ... +180 °C	+10 ... +180 °C
Min. target size (flat)	Ø 36 mm	Ø 27 mm
Sensor type	unshielded	shielded
Connection	integrated cable, axial, standard length 3 m; 1 m, 6 m, 9 m optional ⁵⁾	integrated cable, axial, standard length 3 m; 1 m, 6 m, 9 m optional ⁵⁾
Mounting	Cable gland (M12)	Cable gland (M18)
Temperature range	Storage	-50 ... +200 °C
	Operation	-20 ... +200 °C
Pressure resistance	20 bar (front); 5 bar (rear)	20 bar (front); 5 bar (rear)
Shock (DIN-EN 60068-2-29)	30 g	30 g
Vibration (DIN-EN 60068-2-6)	15 g	15 g
Protection class (DIN-EN 60529)	IP68 (plugged)	IP68 (plugged)
Material	stainless steel and plastic	stainless steel and plastic
Weight	12 g (without nuts)	30 g (without nuts)

¹⁾ Valid for operation with DT306x controller, referred to nominal measuring range

²⁾ Relates to mid of measuring range

³⁾ RMS value of the signal noise, static (20 Hz)

⁴⁾ Only with DT3061 controller and 5-point linearization

⁵⁾ Length tolerance cable: nominal value +30 %

Connection cable for DT3060 portfolio sensors

Sensors with integrated cable: cable type ES-xx-C-CAx

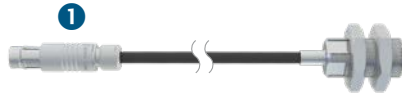

Coaxial cable with Viton sheathing

Cable diameter: Ø 3.6 mm

Minimum bending radius: static approx. 18 mm / dynamic approx. 36 mm

Temperature resistance: up to 200 °C (3000 hrs.)

Available length: 1 m / 3 m / 6 m (9 m on request)

Sensors with socket: cable type EC-x/mB0/mB0



Coaxial cable with Viton sheathing

Cable diameter: Ø 3.6 mm

Minimum bending radius: static approx. 18 mm / dynamic approx. 36 mm

Temperature resistance: up to 200 °C (3000 hrs.)

Available length: 1 m / 3 m / 6 m (9 m on request)

Extension cable: cable type ECE-x/fB0/mB0

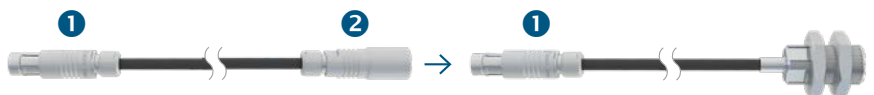

Coaxial cable with Viton sheathing

Cable diameter: Ø 3.6 mm

Minimum bending radius: static approx. 18 mm / dynamic approx. 36 mm

Temperature resistance: up to 200 °C (3000 hrs.)

Available length: 1 m / 3 m / 6 m (9 m on request)

Plug/Socket

1 Connector Triax 0323118: Type S 102 A014-120 D4,1

Triaxial connector:

Type: mB0

Connection: push-pull

Temperature resistance: 200 °C (3000 hrs.)



2 Socket Triax 0323141: Type KE102 A014-120 D4,1

Triaxial socket:

Type: fB0

Connection: push-pull

Temperature resistance: 200 °C (3000 hrs.)



Article	Description	DT3001	DT3005	DT3060	DT3300	DZ140	SGS
PCx/8-M12	Supply and signal cable 8-pole with M12 connector Standard length: 3 m Optionally available: 5 m / 10 m / 15 m / 10 m as drag-chain suitable variant			X			
PCx/5-M12	Supply and signal cable 5-pole with M12 connector Standard length: 5 m Optionally available: 20 m	X	X				
PC4701-x	Supply and signal cable 8-pole with M12 connector Standard length: 10 m Optionally available: 15 m / 10 m as drag-chain suitable variant						X
SCD2/4/RJ45	Industrial Ethernet cable 4-pole with M12 connector on RJ45 connector Standard length: 2 m			X			
SCAx/5	Signal cable, analog 5-pole with M16x0.75 connector Standard length: 3 m Optionally available: 6 m / 9 m				X		
SCDx/8	Signal cable for switching inputs and outputs: 8-pole with M16x0.75 connector Standard length: 0.3 m Optionally available: 1 m				X		
PSCx	Supply and synchronization cable 5-pole with M9 connector Standard length: 0.3 m Optionally available: 1 m				X		
ESCx	Synchronization cable 5-pole with M9 connector Standard length: 0.3 m Optionally available: 1 m				X		
PC140-x	Supply and signal cable 8-pole connector Standard length: 3 m Optionally available: 6 m					X	
PS2020	Power supply unit Input 100-240 VAC output 24 VDC / 2.5 A; mounting onto symmetrical standard rail 35 mm x 7.5 mm, DIN 50022	X	X	X	X	X	X

Sensors and Systems from Micro-Epsilon



Sensors and systems for displacement, distance and position



Sensors and measurement devices for non-contact temperature measurement



Measuring and inspection systems for metal strips, plastics and rubber



Optical micrometers and fiber optics, measuring and test amplifiers



Color recognition sensors, LED analyzers and inline color spectrometers

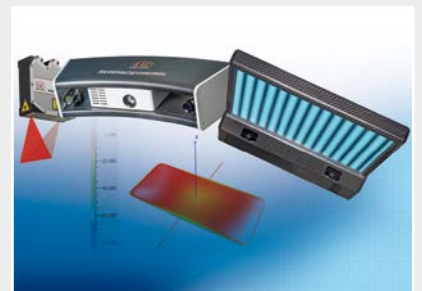

3D measurement technology for dimensional testing and surface inspection