

**SHORT FORM  
SENSORS**



# A new performance class of innovative sensor technology

The delivery program: innovative and extensive. Besides through-beam and retroreflective types, reflective sensors and optical fiber photoelectric sensors, we also offer laser and eddy current analog sensors that provide precise measurement results even in the most complicated of applications.

Our delivery program also includes safety sensors, photoelectric sensors for special applications, inductive proximity switches and miniature pressure sensors for relative or differential pressure measurement, and ionizers for Electro Static Discharge (ESD) applications.

## Application range

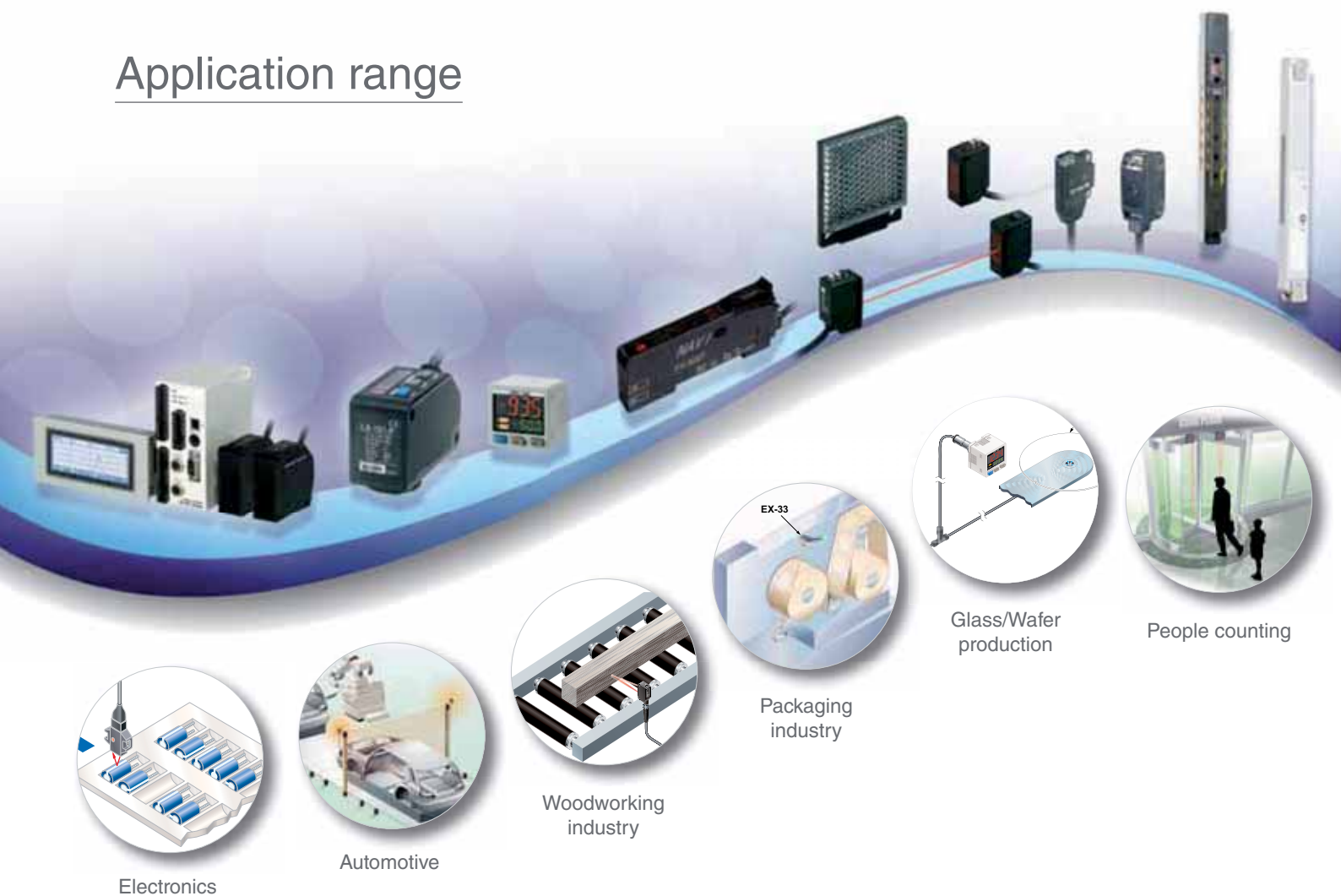

## Service has priority

We are constantly striving to optimize our service sector to enable us to react quickly to customer requests. Whether you have specific application requests or simply want technical information, – we are always ready to advise and assist you; you only have to call. Our current delivery program is assembled for you in this sensor overview. Besides the most important technical data,

you will find numerous illustrations of possible applications. Of course, detailed data sheets are available for download on our website [www.panasonic-electric-works.com](http://www.panasonic-electric-works.com). Our product managers, sales and application engineers will be happy to advise you.

# Contents

	Page		Page
<b>Photoelectric Sensors / Standard Sensors.....</b>	<b>4</b>	<b>Safety Sensors .....</b>	<b>66</b>
CX-400 Vers. 2 .....	4	ST4 .....	66
NX5 .....	8	SF2B Vers.2 .....	68
CY-100 .....	10	SF4B<V2> .....	70
<b>Photoelectric Sensors / Miniature Sensors.....</b>	<b>12</b>	SF4C .....	73
EX-10 Vers. 2 .....	12	SD3-A1 .....	75
EX-20 Vers. 2 .....	14	SQ4 .....	77
EX-30 Vers. 2 .....	16	SF-C10 .....	79
PM .....	18	<b>Pressure &amp; Flow Sensors.....</b>	<b>80</b>
PM2 .....	21	DP-100 .....	80
<b>Photoelectric Sensors / Trigonometric Sensors .....</b>	<b>23</b>	DP2 .....	82
EQ-500 .....	23	DP4 .....	84
EQ-30 .....	25	DP-M .....	86
MQ-W .....	26	DPC-100/DPH-100 .....	87
<b>Photoelectric Sensors / Area Sensors.....</b>	<b>27</b>	DPC-L100/DPH-L100 .....	89
NA1-11 .....	27	DP5/DPH .....	91
NA1-PK5/ NA1-PK3 .....	29	FM-200 .....	93
<b>Fiber-optic Sensors .....</b>	<b>32</b>	<b>Inductive Proximity Sensors.....</b>	<b>96</b>
FX-100 .....	32	GX-M .....	96
FX-301 .....	34	GX-F/H .....	98
FX-311 .....	36	<b>Measurement Sensors .....</b>	<b>100</b>
FX-500 .....	37	HL-G1 .....	100
<b>Standard Fibers.....</b>	<b>40</b>	LM-10 .....	102
Fibers with integrated high-precision plug .....	40	HL-C1 .....	104
Threaded fibers .....	42	HL-C2 .....	106
Cylindrical fibers .....	44	HL-T1 .....	108
Fibers with sleeve .....	45	GP-X .....	110
Flat fibers .....	47	<b>Ionizers/Electrostatic Sensors .....</b>	<b>112</b>
Wide beam fibers .....	48	ER-Q .....	112
Convergent reflective fibers for glass detection .....	49	ER-F .....	113
Chemical-resistant fibers .....	50	ER-X .....	115
Heat-resistant fibers .....	51	ER-TF .....	117
Vacuum-resistant fibers .....	53	ER-VW .....	119
Fibers for liquid leak/liquid detection .....	54	ER-V .....	121
<b>Fiber Sensors Communication Units .....</b>	<b>56</b>	EC-G .....	123
FX-CH2 .....	56	EF-S1 .....	124
SC-GU1-485 .....	57	<b>Accessories .....</b>	<b>126</b>
SC-GU3 .....	58	<b>Index .....</b>	<b>129</b>
<b>Mark Sensors.....</b>	<b>60</b>	<b>Further Panasonic products.....</b>	<b>132</b>
LX-100 .....	60		
<b>Laser Sensors .....</b>	<b>62</b>		
EX-L200 .....	62		
LS .....	64		

- Photoelectric Sensors
- Fiber-optic Sensors
- Standard Fibers
- Fiber Sensors Communication Units
- Mark Sensors
- Laser Sensors
- Safety Sensors
- Pressure & Flow Sensors
- Inductive Proximity Sensors
- Measurement Sensors
- Ionizers/ Electrostatic Sensors
- Accessories
- Index



## CX-400 Vers. 2

A full lineup of world standard photoelectric sensors

### Features

#### ■ Great lineup of 170 models

The **CX-400** series has a high level of basic functionality and excellent cost performance. Moreover, a wide number of variations means that there is sure to be a sensor that fits your needs.

Type	Sensing range
CX-413 □ Thru-beam (long sensing range)	30m
CX-412 □ Thru-beam	15m
CX-411 □ Thru-beam	10m
CX-493 □ Retroreflective (long sensing range)	5m
CX-491 □ Retroreflective (with polarizing filters)	3m
CX-482 □ Retroreflective (transparent object sensing)	0.1 - 2m
CX-483 □ Retroreflective (transparent object sensing)	50 - 1000mm
CX-481 □ Retroreflective (transparent object sensing)	50 - 500mm
CX-422 □ Diffuse reflective type	800mm
CX-421 □ Diffuse reflective type	300mm
CX-424 □ Diffuse reflective type	100mm
CX-423 □ Diffuse reflective (narrow-view)	70 - 200mm
CX-442 □ Adjustable range reflective	20 - 300mm
CX-444 □ Adjustable range reflective	15 - 100mm
CX-443 □ Adjustable range reflective	2 - 50mm
CX-441 □ Adjustable range reflective (small spot)	2 - 50mm

<b>Output</b>	<b>NPN, PNP</b>
<b>Connecting method (Note 1)</b>	Cable type, M8 plug-in connector type, M12 pigtailed type
<b>Cable length of cable type (Note 2)</b>	<b>0.5m, 2m, 5m</b>

#### Notes:

- 1) Only the cable type and M8 plug-in connector type are available for the adjustable range reflective type.
- 2) Only the 2m cable length type (standard) is available for the adjustable range reflective type.

#### ■ Compact size

The sensors are compact in size at 11.2x31x20mm (WxHxD). The mounting pitch is also at the world standard size of 25.4mm (1inch).

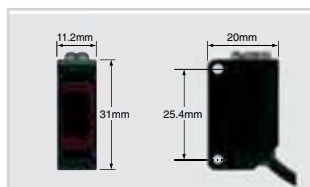

#### ■ Less processing

M8 plug-in connector type and M12 pigtailed type are available. This contributes to less time spent setting up. In addition, cable types are available with the following cable lengths: 0.5m, 2m, and 5m.

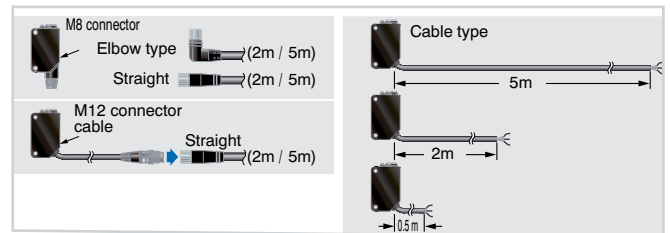

#### ■ Less power consumed

By relentlessly developing our technologies, we have been able to considerably reduce our sensors' power consumption.

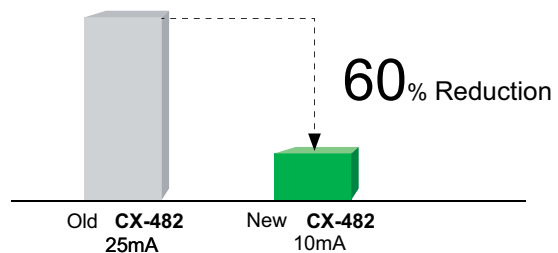

#### ■ Less resources used

Based on environmental considerations, simplified packaging is used in order to reduce waste.

In addition, the bag is made of polyethylene, which produces no toxic gases even when burned.

**Strong against oil and coolant liquids** CX-41□/42□/49□

The lens material for the thru-beam type, retroreflective type (excluding the CX-48□) and the diffuse reflective type is made of a strong acrylic that resists the harmful effects of coolants. These sensors can be used with confidence even around metal processing machinery that disperses oil mists. The protection mechanism also conforms to IP67 (IEC).

**Strong against ethanol** CX-44□/48□

A strong, ethanol-resistant polycarbonate is used for the front and display covers. Safe even for installing near food processing machinery that disperses ethanol-based detergents. The protection mechanism also conforms to IP67 (IEC).

**Strong against interference**

The interference prevention function allows two sensors to be mounted close together.

- Photoelectric Sensors
- Fiber-optic Sensors
- Standard Fibers
- Fiber Sensors Communication Units
- Mark Sensors
- Laser Sensors
- Safety Sensors
- Pressure & Flow Sensors
- Inductive Proximity Sensors
- Measurement Sensors
- Ionizers / Electrostatic Sensors
- Accessories
- Index

# Typical applications

**Detecting cars on conveyor lines**



Thru-beam type CX-412□

**Strong infrared beam**  
It realizes a 15m long-distance sensing range. Remarkable penetrating power enables applications such as package content detection.

**Detecting transparent bottles**

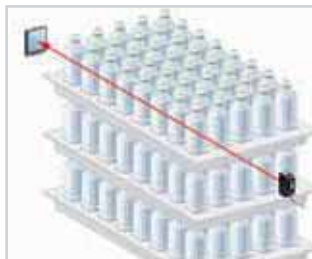

Retroreflective type CX-493□

**Strongest sensing range in its class**  
A long 5m sensing range is possible with the red LED type that is easy to align with the beam axis. Can be used for wide automatic door shutters.

**Detecting labels**

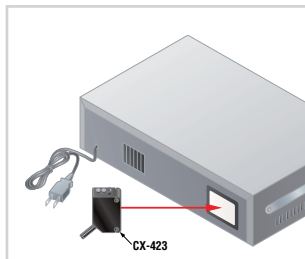

Diffuse reflective type CX-423□

**Beam axis alignment made easy**  
These sensors realize a high luminance red LED spot that provides bright visibility enabling the sensing position to be checked at a glance. Because it has the small spot, approx. 2mm, even the minutest object can be accurately detected.

CX-481□/482□

**Introducing the transparent object sensing type sensor**  
Our unique optical system and transparent object sensing circuitry provide stable sensing of even thinner transparent objects than the conventional models.



CX-441/443□

**Can sense differences as small as 0.4mm, with hysteresis of 2% or less**  
An advanced optical system provides sensing performance that is approx. 2.5 times more precise than conventional models. Even ultra small differences of 0.4mm can be detected accurately.



CX-44□

**Not affected by color**  
Both black and white objects can be sensed at almost the same distances. No adjuster control is needed, even when products of different colors are moving along the production line.

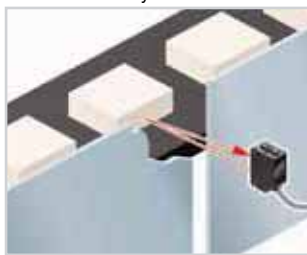

**BGS/FGS functions make even the most challenging settings possible!**

**Background suppression**

When object and background are separated.



**Foreground suppression**

When object and background are close together. When the object is glossy or uneven.

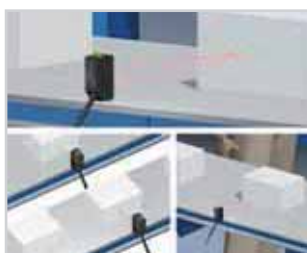
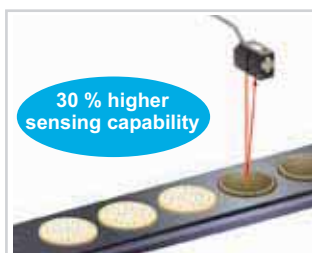
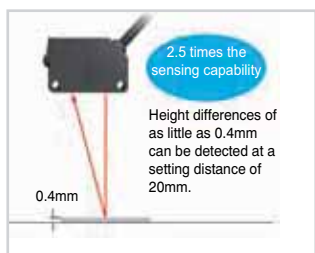

## Technical specifications

Photoelectric Sensors

Fiber-optic Sensors

Standard Fibers

Fiber Sensors Communication Units

Mark Sensors

Laser Sensors

Safety Sensors

Pressure & Flow Sensors

Inductive Proximity Sensors

Measurement Sensors

Ionizers / Electrostatic Sensors

Accessories

Index

Standard Sensors

CX-400

Type		Thru-beam			Retroreflective				
		Long sensing range			With polarizing filter	Long sensing range	For transparent object sensing		
Model no.	NPN	CX-411(-Z) (Note 1)	CX-412(-Z)	CX-413(-Z)	CX-491(-Z)	CX-493(-Z)	CX-481(-Z)	CX-483(-Z)	CX-482(-Z)
	PNP	CX-411-P(-Z)	CX-412-P(-Z)	CX-413-P(-Z)	CX-491-P(-Z)	CX-493-P(-Z)	CX-481-P(-Z)	CX-483-P(-Z)	CX-482-P(-Z)
Sensing range		10m	15m	30m	3m (Note 2)	5m (Note 2)	50 to 500mm (Note 2)	50 to 1.0m (Note 2)	0.1 to 2m (Note 2)
Object to be sensed		Ø 12mm (opaque)			Ø 50mm (opaque, transparent) (Note 2)	Ø 50mm (opaque, transparent or specular) (Note 2)			
Hysteresis		-							
Supply voltage		12 to 24VDC ±10%							
Output		PNP / NPN open-collector transistor, max. 100mA							
Output operation		Switchable either Light-ON or Dark-ON							
Response time		1ms or less		2ms or less	1ms or less				
Emitting element		Red LED	Infrared LED		Red LED			Infrared LED	
Automatic interference prevention function		Two units of sensors can be mounted close together with interference prevention filters. (Sensing range: 5m)		-	Incorporated (two sensor units can be mounted close together.)				
Protection		IP67 (IEC)							
Ambient temperature		-25 to +55°C							
Material		Enclosure: PBT, Lens: Polycarbonate (CX-48□: Polycarbonate), Protection cover: Polycarbonate (CX-48□: Polycarbonate)							
Connection method		2m cable, Suffix - Z: M8 connector (Note 3)							
Dimensions (HxWxD)		31x11.2x20mm (-Z connector type: 35.5x11.2x20mm)							
Accessories		-			Reflector: RF-230 1 pc.				

### Notes:

- 1) Suffix -Z = M8 connector type
- 2) The sensing range is specified for the attached reflector RF-230
- 3) Cable is not included in delivery. Please select under accessories (page 125)

Type		Diffuse reflective				Adjustable range reflective			
					Narrow view	Small spot			
Model no.	NPN	CX-424(-Z) (Note 1)	CX-421(-Z)	CX-422(-Z)	CX-423(-Z)	CX-441(-Z)	CX-443(-Z)	CX-444(-Z)	CX-442(-Z)
	PNP	CX-424-P(-Z)	CX-421-P(-Z)	CX-422-P(-Z)	CX-423-P(-Z)	CX-441-P(-Z)	CX-443-P(-Z)	CX-444-P(-Z)	CX-442-P(-Z)
Sensing range		100mm	300mm	800mm	70 to 300mm	2 to 50mm (adjustable range: 20-50mm)		15 to 100mm (adjustable range: 20-100mm)	20 to 300mm (adjustable range: 40-300mm)
Object to be sensed		Opaque, transparent				-			
Hysteresis		<15% or less of sensing range				<2% or less of sensing range			<5% or less of sensing range
Supply voltage		12 to 24VDC $\pm$ 10%							
Output		PNP / NPN open-collector transistor, max. 100mA							
Output operation		Switchable either Light-ON or Dark-ON							
Response time		1ms or less							
Emitting element		Infrared LED			Red LED	Red LED			
Automatic interference prevention function		Incorporated (two sensor units can be mounted close together.)							
Protection		IP67 (IEC)							
Ambient-temperature		-25 to +55°C							
Material		Enclosure: PBT, Lens: Polycarbonate (CX-48□: Polycarbonate), Protection cover: Polycarbonate (CX-48□: Polycarbonate)							
Connection method		2m cable, Suffix - Z: M8 connector (Note 3)							
Dimensions (HxWxD)		31x11.2x20mm (-Z connector type: 35.5x11.2x20mm)							

**Notes:**

- 1) Suffix -Z = M8 connector type
- 2) FGS = Foreground suppression  
BGS = Background suppression  
Selectable by wiring the inputs correspondingly
- 3) Cable is not included in delivery. Please select under accessories (page 125).

Fiber-optic Sensors

Standard Fibers

Fiber Sensors Communication Units

Mark Sensors

Laser Sensors

Safety Sensors

Pressure &amp; Flow Sensors

Inductive Proximity Sensors

Measurement Sensors

Ionizers / Electrostatic Sensors

Accessories

Index

Standard Sensors

CX-400

- Photoelectric Sensors
- Fiber-optic Sensors
- Standard Fibers
- Fiber Sensors Communication Units
- Mark Sensors
- Laser Sensors
- Safety Sensors
- Pressure & Flow Sensors
- Inductive Proximity Sensors
- Measurement Sensors
- Ionizers/ Electrostatic Sensors
- Accessories
- Index
- Standard Sensors
- NX5



# NX5

**Sensor usable world-wide**

## Features

### ■ Multi-voltage

24 to 240VAC and 12 to 240VDC, suitable for supply voltages all over the world.

### ■ High reliability

The hermetically sealed output relay significantly increases its reliability.

### ■ Interference prevention

Two sensors operate normally even when mounted close together (excluding the 30m thru-beam type sensor).

### ■ Long sensing range

Suitable for conveyor lines and parking lot applications.

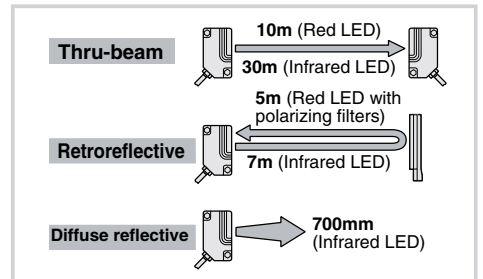
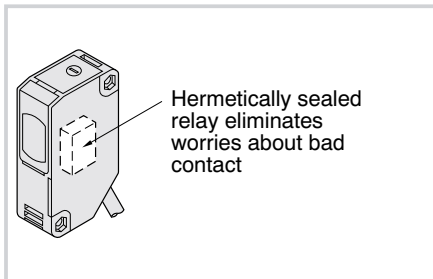

## Typical applications

### Multistoried parking

Detects if the car is protruding from the elevator door.

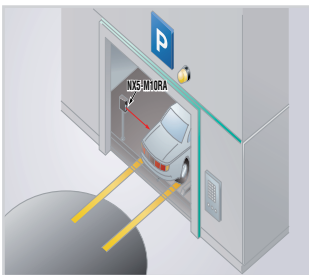

### Golf driving range

The sensor detects the presence of a golf ball. The sensor is multi-voltage type so no DC power supply is needed.

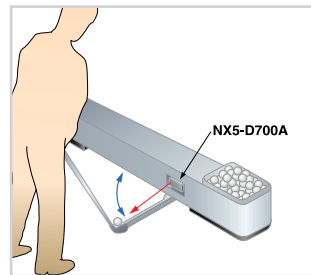

### Arresting shutter closing

The long sensing range sensor with a visible red beam can be used to control the shutter operation at the gate of a factory.

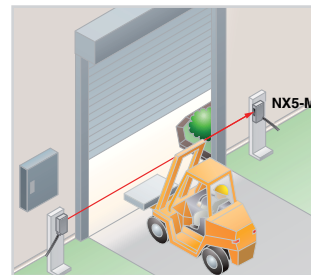

### Arresting door closing

The sensor detects a person or an object and prevents the door from closing as long as its beam is interrupted.

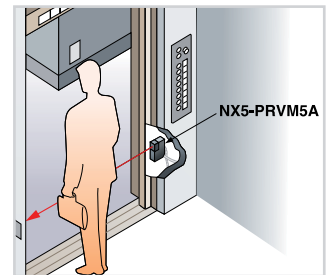



# Technical specifications

Type	Thru-beam				Retroreflective				Diffuse reflective	
			Long sensing range		With polarizing filters		Long sensing range			
Model no.	NX5-M10RA	NX5-M10RB	NX5-M30A	NX5-M30B	NX5-PRVM5A	NX5-PRVM5B	NX5-RM7A	NX5-RM7B	NX5-D700A	NX5-D700B
Sensing range	10m		30m		0.1 to 5m (Note 1)		0.1 to 7m (Note 1)		700mm (Note 2)	
Object to be sensed	Ø 20mm or more; opaque transparent object (Note 3)				Ø 50mm or more; opaque, semitransparent or transparent object (Note 1, 3)		Ø 50mm or more; opaque or translucent object (Note 1, 3)		Opaque, semitransparent or transparent object (Note 3)	
Hysteresis	—									
Repeatability (perpendicular to sensing axis)	0.1mm or less			0.2mm or less				0.3mm or less		
Supply voltage	24 to 240VAC ± 10%, or 12 to 240VDC ± 10%									
Power consumption	Emitter: 1VA or less Receiver: 2VA or less		Emitter: 1.5VA or less Receiver: 2VA or less		2VA or less					
Output	Relay contact 1c Switching capacity: 250VAC 1A (resistive load) 30VDC 2A (resistive load) Electrical life: 500,000 or more switching operations (switching frequency 3600 operations/hour) Mechanical life: 100 million or more switching operations (switching frequency 36,000 operations/hour)									
Output operation	Light-ON	Dark-ON	Light-ON	Dark-ON	Light-ON	Dark-ON	Light-ON	Dark-ON	Light-ON	Dark-ON
Response time	10ms or less									
Power indicator	—		Red LED (lights up when the power is ON)			—				
Sensitivity adjuster	Continuously variable adjuster		—		Continuously variable adjuster		—		Continuously variable adjuster	
Automatic interference prevention function	Use optional interference prevention filters		—		Incorporated (two sensor units can be mounted close together.)					
Protection	IP66 (IEC)									
Ambient temperature	-20 to +55°C									
Emitting element	Red LED		Infrared LED		Red LED		Infrared LED			
Material	Enclosure: Polycarbonate; lens: polycarbonate; cover: polycarbonate; front cover (retroreflective type sensor only): Acrylic									
Connection method	5-core (thru-beam type emitter: 2 cable) cable, 2m									
Dimensions (HxWxD)	62x18x35mm									
Accessories	Adjusting screwdriver: 1 pc.		—		Reflektor RF-230: 1 pc. Adjusting screwdriver: 1 pc.		Reflektor RF-230: 1 pc.		Adjusting screwdriver: 1 pc.	

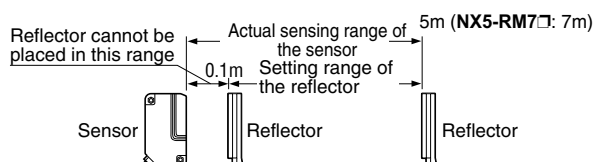

## Notes:

- 1) The sensing range and the sensing object of the retroreflective type sensor is specified for the **RF-230**. Further, the sensing range is the possible setting range for the reflector. The sensor can also detect an object 0.1m, or more, away.
- 2) The sensing range is specified for white non-glossy paper (200x200m).
- 3) Check the functionality with a real object.

- Photoelectric Sensors
- Fiber-optic Sensors
- Standard Fibers
- Fiber Sensors Communication Units
- Mark Sensors
- Laser Sensors
- Safety Sensors
- Pressure & Flow Sensors
- Inductive Proximity Sensors
- Measurement Sensors
- Ionizers/ Electrostatic Sensors
- Accessories
- Index
- Standard Sensors
- CY-100



# CY-100

**Simple mounting with M18 thread**

## Features

### ■ Wide product range

The availability of a wide range of models within the series means the **CY-100** sensors can solve relatively complex tasks. Types with integrated polarization filters can even recognize reflective objects. The side view type makes applications possible in cramped spaces.

### ■ M18 Thread

All models have an M18 male thread for easy and quick mounting. Furthermore the models are also available for the M12 connector type. You can easily replace and add these standard models. The nuts are included in delivery.

### ■ Long sensing range

The thru-beam and retroreflective types of the CY-100 have a large sensing range of up to 15m.

### ■ Environmentally robust

Thanks to the IP67 (IEC) casing, the sensor is suitable for installation in humid and dusty environments. Integrated status LEDs allow the operator to check the function of the sensor at a glance.

## Typical applications

### Object detection

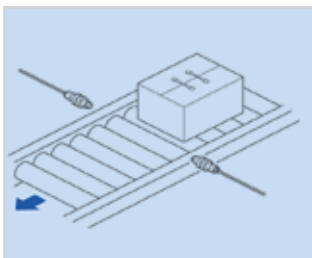

### Detecting specular objects

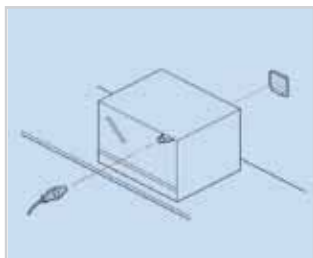

### Object counting

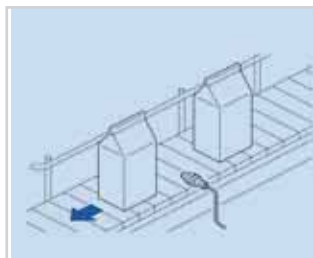

# Technical specifications

## Standard type

Type		Thru-beam		Retroreflective type (Note 3)				Diffuse			
		-		-		With polarizing filter		-		With sensitivity adjuster	
		Light-ON	Dark-ON	Light-ON	Dark-ON	Light-ON	Dark-ON	Light-ON	Dark-ON	Light-ON	Dark-ON
Model no.	NPN	CY-111A (-Z) (Note)	CY-111B (-Z)	CY-192A (-Z)	CY-192B (-Z)	CY-191A (-Z)	CY-191B (-Z)	CY-121A (-Z)	CY-121B (-Z)	CY-122A (-Z)	CY-122B (-Z)
	PNP	CY-111A-P (-Z)	CY-111B-P (-Z)	CY-192A-P (-Z)	CY-192B-P (-Z)	CY-191A-P (-Z)	CY-191B-P (-Z)	CY-121A-P (-Z)	CY-121B-P (-Z)	CY-122A-P (-Z)	CY-122B-P (-Z)
Sensing range		15m		4m		2m		100mm (Note 2)		600mm (Note 2)	
Object to be sensed		Ø 18mm (opaque)		Ø 50mm (opaque, transparent) (Note 1)		Ø 50mm (opaque, transparent or specular) (Note 1)		Opaque, transparent			
Supply voltage		12 to 24VDC ±10%									
Output		PNP / NPN open-collector transistor, max. 100mA									
Response time		1ms or less									
Emitting element		Infrared LED				Red LED		Infrared LED			
Protection		IP67 (IEC)									
Ambient temperature		-25 to +55°C									
Material		Enclosure: PBT, Lens: PMMA									
Connection method		2m cable, Suffix - Z: M12 connector (Note 4)									
Dimensions (HxWxD)		M18x46mm, -Z connector type: M18x60mm				M18 x 48mm, -Z connector type: M18x62mm		M18x46mm, -Z connector type: M18x60mm		M18x62mm, -Z connector type: M18x76mm	
Accessories		Nuts 4 pcs.		Nuts 2 pcs.				Nuts 2 pcs. Screwdriver 1pc.			

## Side sensing

Type		Thru-beam		Retroreflective type (Note 3)				Diffuse			
		-		-		With polarizing filter		-		With sensitivity adjuster	
		Light-ON	Dark-ON	Light-ON	Dark-ON	Light-ON	Dark-ON	Light-ON	Dark-ON	Light-ON	Dark-ON
Model no.	NPN	CY-111VA(-Z)	CY-111VB(-Z)	CY-192VA(-Z)	CY-192VB(-Z)	CY-191VA(-Z)	CY-191VB(-Z)	CY-121VA(-Z)	CY-121VB(-Z)	CY-122VA(-Z)	CY-122VB(-Z)
	PNP	CY-111VA-P(-Z)	CY-111VB-P(-Z)	CY-192VA-P(-Z)	CY-192VB-P(-Z)	CY-191VA-P(-Z)	CY-191VB-P(-Z)	CY-121VA-P(-Z)	CY-121VB-P(-Z)	CY-122VA-P(-Z)	CY-122VB-P(-Z)
Sensing range		15m		4m		2m		100mm (Note 2)		600mm (Note 2)	
Object to be sensed		Ø 18mm (opaque)		Ø 50mm (opaque, transparent) (Note 1)		Ø 50mm (opaque, transparent or specular) (Note 1)		Opaque, transparent			
Supply voltage		12 to 24VDC ±10%									
Output		PNP / NPN open-collector transistor, max. 100mA									
Response time		1ms or less									
Emitting element		Infrared LED				Red LED		Infrared LED			
Protection		IP67 (IEC)									
Ambient temperature		-25 to +55°C									
Material		Enclosure: PBT, Lens: PMMA									
Connection method		2m cable, Suffix - Z: M12 connector (Note 4)									
Dimensions (ØxD)		M18x62mm, -Z connector type: M18x76mm						M18x46mm, -Z connector type: M18x60mm		M18x78mm, -Z connector type: M18x92mm	
Accessories		Nuts 4 pcs.		Nuts 2 pcs.				Nuts 2 pcs. Screwdriver 1 pc.			

### Notes:

Suffix -Z = M12 connector type

- 1) The sensing range and sensing object of the retroreflective type are specified for the reflector **RF-420** (accessories page 126)
- 2) The sensing range is specified for white, matt paper
- 3) The reflector is not included in delivery; please order separately (accessories page 126)
- 4) Cable not included in delivery, please order separately (accessories page 125)

- Photoelectric Sensors
- Fiber-optic Sensors
- Standard Fibers
- Fiber Sensors Communication Units
- Mark Sensors
- Laser Sensors
- Safety Sensors
- Pressure & Flow Sensors
- Inductive Proximity Sensors
- Measurement Sensors
- Ionizers/ Electrostatic Sensors
- Accessories
- Index



## EX-10 Vers. 2

**The slimmest: 3.5mm thick**

### Features

■ **Freely mountable fingertip size**

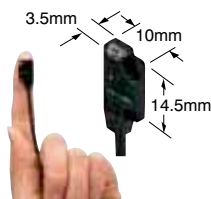

Freely mountable; dimensions 10x14.5x3.5mm (WxHxD) (Thru-beam type, front sensing). Moreover, easy alignment is possible with the visible red LED beam source.

■ **2-color indicator**

A convenient bright, 2-color indicator has been incorporated in the miniature body. You can check the available power supply and current output operation at a glance.



■ **Less power consumed**

By relentlessly developing our technologies, we have been able to considerably reduce our sensors' power consumption.

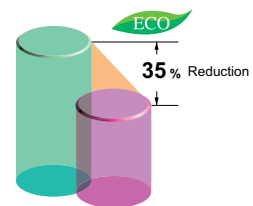

■ **Sensing range 1m: EX-19□**

■ **High-speed response time: 0.5ms**

The sensor **EX-10** with a response time of only 0.5ms is especially suitable for detecting small and high-speed traveling objects.

■ **Flexible setup**

The EX-10 sensor is available as front sensing or side sensing type, allowing for flexible mounting in the narrowest of spaces.

### Typical applications

**Detecting the float for a flow meter**

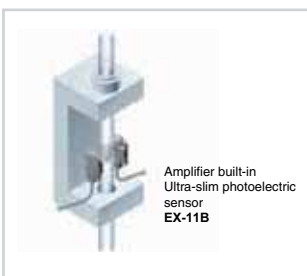

**Seating confirmation fiber**

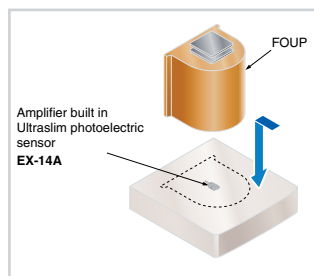

**Detecting small parts such as screws**

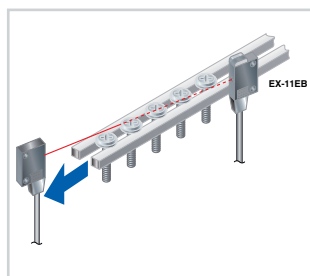

**Sensing PCB rack**

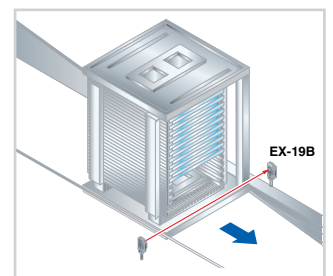

# Technical specifications

Type		Thru-beam						Convergent reflective	
Model no.	Front sensing	EX-11A(-PN) (Note)	EX-11B(-PN)	EX-13A(-PN)	EX-13B(-PN)	EX-19A(-PN)	EX-19B(-PN)	EX-14A(-PN)	EX-14B(-PN)
	Side sensing	EX-11EA(-PN)	EX-11EB(-PN)	EX-13EA(-PN)	EX-13EB(-PN)	EX-19EA(-PN)	EX-19EB(-PN)	–	–
<b>Sensing range</b>		150mm		500mm		1m		2 to 25mm (conv. point: 10mm)	
<b>Minimum sensing object</b>		Ø 1mm; opaque object		Ø 2mm; opaque object				Ø 0.1mm copper wire (Setting distance: 10mm)	
<b>Supply voltage</b>		12 to 24VDC ±10%							
<b>Output</b>		PNP / NPN open-collector transistor, max. 50mA							
<b>Output operation</b>		Light-ON	Dark-ON	Light-ON	Dark-ON	Light-ON	Dark-ON	Light-ON	Dark-ON
<b>Response time</b>		0.5ms or less							
<b>Protection</b>		IP67 (IEC)							
<b>Ambient temperature</b>		–25 to +55°C							
<b>Connection method</b>		Cable 2m							
<b>Dimensions (HxWxD)</b>		14.5x10x3.5mm						13x14.5x3.5mm	
<b>Accessories</b>		Mounting screws, 1 set							

**Note:**  
 Suffix -PN = PNP type  
 No suffix = NPN type

- Photoelectric Sensors
- Fiber-optic Sensors
- Standard Fibers
- Fiber Sensors Communication Units
- Mark Sensors
- Laser Sensors
- Safety Sensors
- Pressure & Flow Sensors
- Inductive Proximity Sensors
- Measurement Sensors
- Ionizers/ Electrostatic Sensors
- Accessories
- Index



## EX-20 Vers. 2

Miniature-sized and still mountable with M3 screws

### Features

#### ■ Long sensing range

The EX-20 series achieves long distance sensing [thru-beam type: 2m, retroreflective type: 200mm (when using the attached reflector), diffuse reflective type: 160mm], despite its miniature size. Hence, it is usable even on a wide conveyor.

#### ■ Clear beam spot using red LED dot light source

The emission area of a dot light source is smaller than that of a conventional LED flat light source. It is possible to design a high power, narrow beam. Since a red LED dot light source is used, the red beam spot is clearly visible even at a long distance so that the alignment and confirmation of the sensing position is easy.

#### ■ Less power consumed!

By relentlessly developing our technologies, we have been able to considerably reduce our sensors' power consumption.

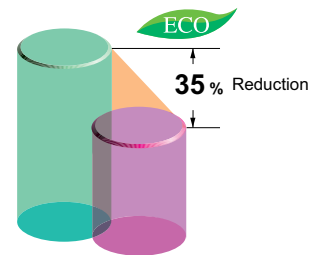
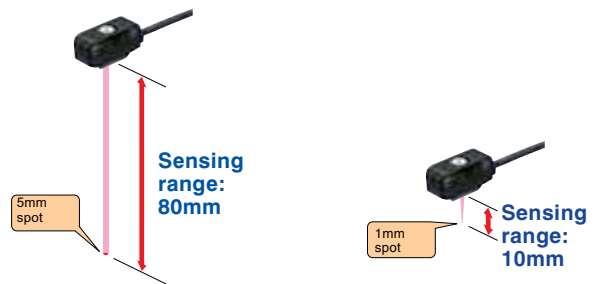

## Typical applications

### Checking protrusion of wafer

The ultra compact photoelectric sensor EX-23 has a sufficiently long sensing range of 2m. Further, its visible red LED beam makes beam alignment very easy.

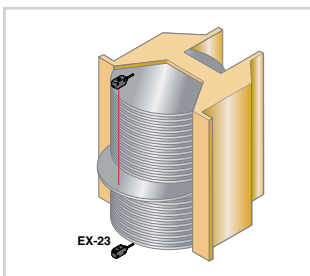

### Detecting tape feeder cassette out of position

Ultra compact in size with an ample sensing range of 2m, ideal for monitoring tape feeder cassettes that are out of position.

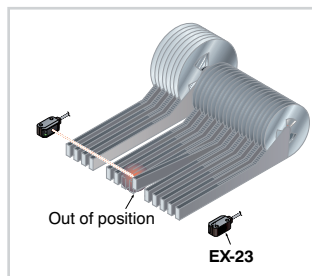

### Detecting fill-up of parts in feeder

The sensor setting can be finely adjusted since a universal sensor mounting bracket is available, with which the height and the angle of the sensor can be freely adjusted.

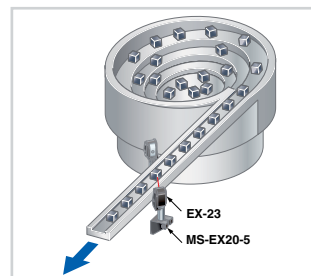

# Technical specifications

Type		Thru-beam		Retroreflective	Diffuse reflective type			
		Front sensing	Side sensing	Side sensing	Standard type	Diffuse beam	Small spot beam	Long distance spot beam
Model no.	Light-ON	EX-21A(-PN) (Note)	EX-23(-PN) Light-ON/Dark-ON switchable	EX-29A(-PN)	EX-22A(-PN)	EX-24A(-PN)	EX-26A(-PN)	EX-28A(-PN)
	Dark-ON	EX-21B(-PN)		EX-29B(-PN)	EX-22B(-PN)	EX-24B(-PN)	EX-26B(-PN)	EX-28B(-PN)
Sensing range		1m	2m	30 to 200mm	5 to 160mm	2 to 25mm (Conv. point: 10mm)	6 to 14mm (Conv. point: 10mm)	45 to 115mm
Object to be sensed		Min. Ø 2.6mm; opaque object	Min. Ø 3mm; opaque object	Min. Ø 15mm opaque or translu- cent object	Opaque, translu- cent or transparent object	Min. Ø 0.1mm copper wire (Setting distance: 10mm)		Opaque, translu- cent or transparent object
Supply voltage		12 to 24VDC ± 10%						
Output		PNP / NPN open-collector transistor, max. 50mA						
Response time		0.5ms or less						
Protection		IP67 (IEC)						
Ambient temperature		-25 to +55°C						
Connection method		Cable 2m						
Dimensions (HxWxD)		18x16x4.5mm	8.2x22x10.5mm	8.2x25x12.3mm		16x18x4.5mm	8.2x25x12.3mm	10x14.5x3.5mm
Accessories		-	Screwdriver, 1 pc.	Reflector <b>RF-200</b> , 1 pc. Screwdriver, 1 pc.	Screwdriver, 1 pc.	-	Screwdriver, 1 pc.	

**Note:**  
Suffix -PN = PNP type  
No suffix = NPN type

Photoelectric  
Sensors

Fiber-optic  
Sensors

Standard Fibers

Fiber Sensors  
Communication  
Units

Mark Sensors

Laser Sensors

Safety Sensors

Pressure & Flow  
Sensors

Inductive Proximity  
Sensors

Measurement  
Sensors

Ionizers/  
Electrostatic  
Sensors

Accessories

Index

Miniature Sensors

EX-20

Photoelectric Sensors

Fiber-optic Sensors

Standard Fibers

Fiber Sensors Communication Units

Mark Sensors

Laser Sensors

Safety Sensors

Pressure & Flow Sensors

Inductive Proximity Sensors

Measurement Sensors

Ionizers/ Electrostatic Sensors

Accessories

Index

Miniature Sensors

EX-30



## EX-30 Vers. 2

An alternative to fiber sensors

### Features

#### ■ An alternative to fiber sensors

The **EX-30** series can be screw-mounted (M4 for thru-beam type, M6 for reflective type). This means that they can be inserted into production lines in exactly the same way as conventional fiber sensors.

#### ■ 800mm thru-beam type available

The sensing range is 1.5 times greater than previous models! It also has a sensitivity adjuster to enable compatibility with a wide range of applications.

#### ■ Less power consumed!

By relentlessly developing our technologies, we have been able to considerably reduce our sensors' power consumption.

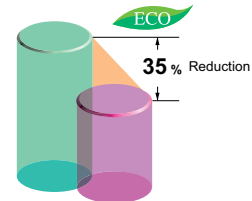

## Typical applications

### Detecting quantity of labels in label magazine

Detects the remaining amount of labels by the thickness of the roll.

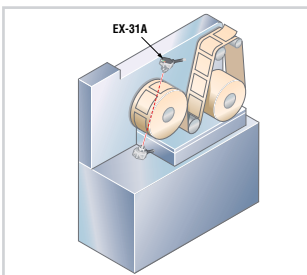

### Detecting ICs

Detects whether ICs are accurately placed in IC trays.

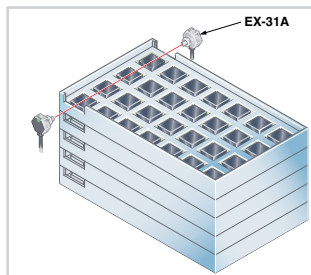

### Resin bottle detection

The **EX-32A** threaded photoelectric sensor confirms the arrival of bottles.

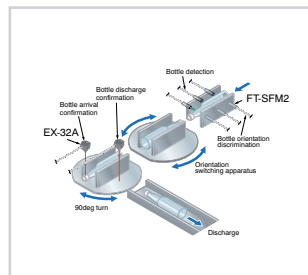



# Technical specifications

Type	Thru-beam				Diffuse reflective	
Model no.	NPN	EX-31A	EX-31B	EX-33	EX-32A	EX-32B
	PNP	EX-31A-PN	EX-31B-PN	EX-33-PN	EX-32A-PN	EX-32B-PN
<b>Sensing range</b>	500mm			800mm	50mm	
<b>Object to be sensed</b>	Min. 2mm or opaque object				Opaque, translucent or transparent object	
<b>Supply voltage</b>	12 to 24VDC ± 10%					
<b>Output</b>	PNP / NPN open-collector transistor, max. 50mA					
<b>Output operation</b>	Light-ON	Dark-ON	Variable switching method	Light-ON	Dark-ON	
<b>Response time</b>	0.5ms or less					
<b>Protection</b>	IP67 (IEC)					
<b>Ambient temperature</b>	-25 to +55°C					
<b>Connection method</b>	Cable 2m					
<b>Dimensions (HxWxD)</b>	14x15.6x18mm					
<b>Accessories</b>	Nuts, 2 pcs.; washers, 2 pcs.				Nut, 1 pc.; washer, 1 pc.	

Photoelectric Sensors

Fiber-optic Sensors

Standard Fibers

Fiber Sensors  
Communication Units

Mark Sensors

Laser Sensors

Safety Sensors

Pressure & Flow Sensors

Inductive Proximity Sensors

Measurement Sensors

Ionizers /  
Electrostatic Sensors

Accessories

Index

Miniature Sensors

EX-30

- Photoelectric Sensors
- Fiber-optic Sensors
- Standard Fibers
- Fiber Sensors Communication Units
- Mark Sensors
- Laser Sensors
- Safety Sensors
- Pressure & Flow Sensors
- Inductive Proximity Sensors
- Measurement Sensors
- Ionizers/ Electrostatic Sensors
- Accessories
- Index



# PM

**Enables equipment miniaturization and quick construction**

## Features

### ■ Compact size

#### Ultra small type

The **PM-□** sensors achieve an extremely compact size and can contribute to the miniaturization of your equipment.

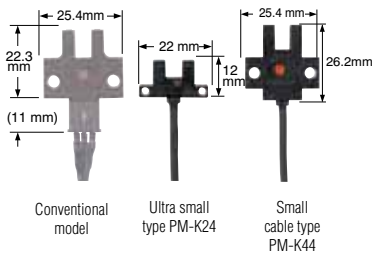

### ■ Quick fitting hook-up connector

Easy to maintain hook-up connector type models are available. A connector attached cable is also available.

### ■ Equipped with two independent outputs

All models are equipped with two independent outputs – Light-ON and Dark-ON. Hence, one model suffices even if the output is to be used differently.

### ■ Flexible cable type

A flexible cable is used, which allows repeated bending. It is suitable for use in the moving part of a robot arm.

- Miniature Sensors
- PM

## Typical applications

### Sensing rotating bodies

By incorporating a slit in the rotating body, the origin point can be sensed.

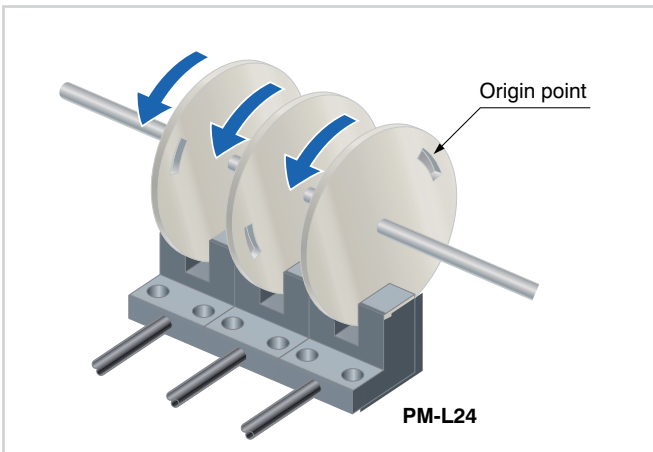

### Determine the pallet position

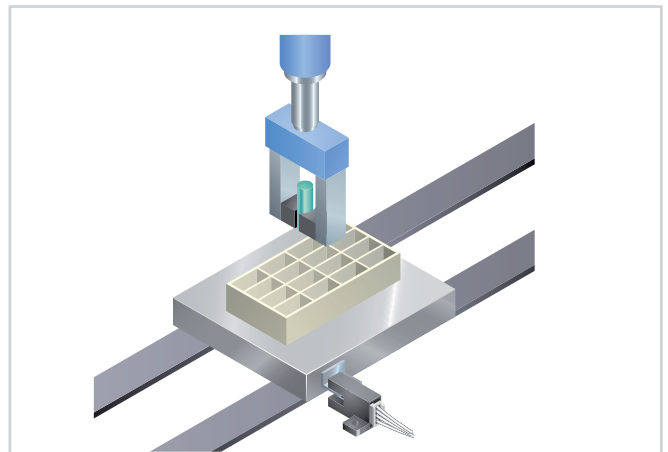

# Order guide

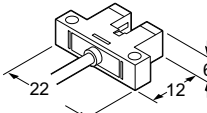
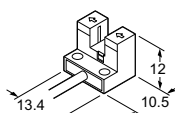
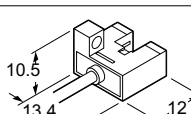
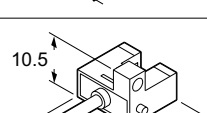
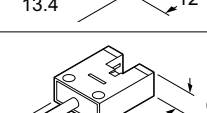
Type	Appearance (mm)	Model no.
Ultrasmall		PM-K24
		PM-K24P
		PM-L24
		PM-L24P
		PM-F24
		PM-F24P
		PM-R24
		PM-R24P
		PM-U24
		PM-U24P

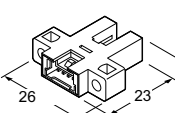
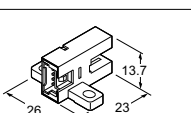
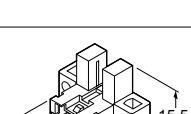
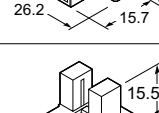
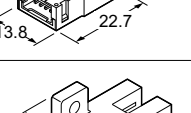
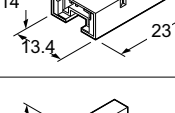
Type	Appearance (mm)	Model no.
Small and built-in connector type		PM-K64
		PM-K64P
		PM-T64
		PM-T64P
		PM-L64
		PM-L64P
		PM-Y64
		PM-Y64P
		PM-F64
		PM-F64P
		PM-R64
		PM-R64P

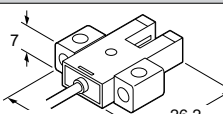
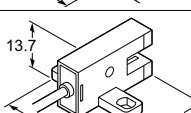
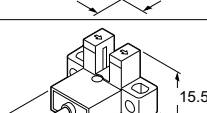
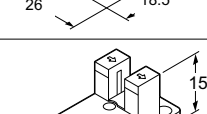
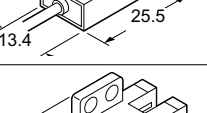
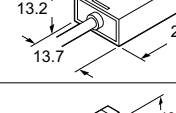
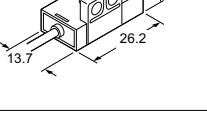
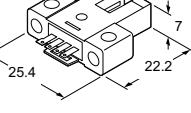
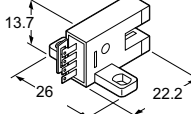
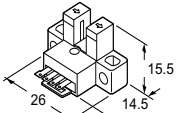
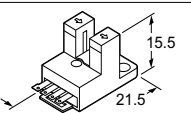
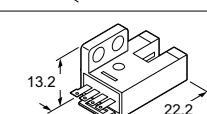
Type	Appearance (mm)	Model no.	
Small		PM-K44	
		PM-K44P	
		PM-T44	
		PM-T44P	
		PM-L44	
		PM-L44P	
		PM-Y44	
		PM-Y44P	
		PM-F44	
		PM-F44P	
		PM-R44	
		PM-R44P	
	With cable		PM-K54
			PM-K54P
		PM-T54	
		PM-T54P	
		PM-L54	
		PM-L54P	
		PM-Y54	
		PM-Y54P	
	PM-F54		
	PM-F54P		
	PM-R54		
	PM-R54P		

## Photoelectric Sensors

Fiber-optic Sensors

Standard Fibers

Fiber Sensors Communication Units

Mark Sensors

Laser Sensors

Safety Sensors

Pressure & Flow Sensors

Inductive Proximity Sensors

Measurement Sensors

Ionizers / Electrostatic Sensors

Accessories

Index

## Miniature Sensors

PM

## Technical specifications

Type		Ultra small type	Small type		
		With cable	With cable	With connector	Built-in connector
Model no.	NPN	PM-□24 (Note 1)	PM-□44	PM-□54	PM-□64
	PNP	PM-□24P	PM-□44P	PM-□54P	PM-□64P
Sensing range		5mm (fixed)			
Minimum sensing object		0.8 x 1.8mm opaque object			
Repeatability		0.03mm or less		0.01mm or less	
Supply voltage		5 to 24V DC ± 10%			
Output		PNP / NPN open-collector transistor, max. 50mA			
Output operation		Incorporated with 2 outputs: Light-ON / Dark-ON			
Response time		Under light incident condition: 20μs or less Under light incident condition: 100μs or less (Response frequency: min. 1kHz)			
Emitting element		Infrared LED			
Connection method		Cable 1m	Connector (Note 2)	Built-in connector (Note 2)	

### Notes:

- 1) K = K type  
L = L type  
F = F type  
R = R type  
U = U type  
T = T type  
Y = Y type
- 2) Cable not included in delivery, please order separately (accessories, page 125)

# PM2

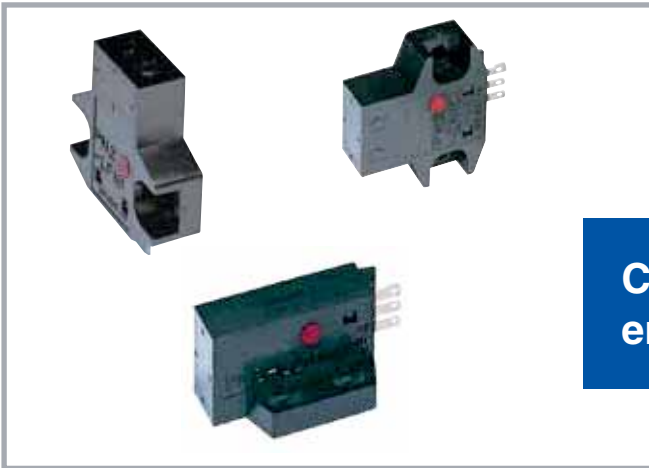

Convergent reflection sensing ensures stable detection

## Features

### ■ Stable detection by convergent reflective mode

The stable detection characteristics of the **PM2** series are obtained since it is a convergent reflective type and senses a limited area. Thus regardless of the background, stable detection is possible.

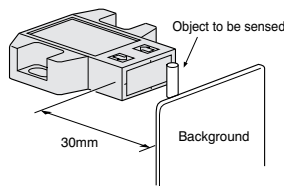

### ■ Not affected by background

Even a specular background does not affect the sensing performance if the sensor is located 30mm away from it (when directly opposite).

### ■ Dark object detectable

Since the sensor is very sensitive, it can detect even a dark object of low reflectivity.

### ■ Minimum sensing object

A 0.05mm copper wire can be detected at a distance of 5mm.

## Typical applications

### Minute object detectable

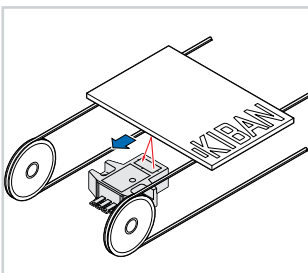

### Starting point and overrun is sensed using the dog on the base

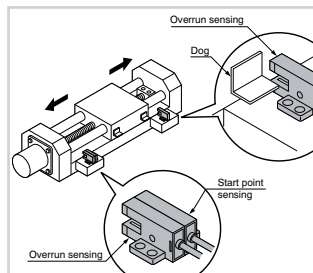

### Detecting capacitors in tray

The convergent reflective type sensor reliably detects capacitors in a tray without being affected by their color, characters, marks or glossiness.

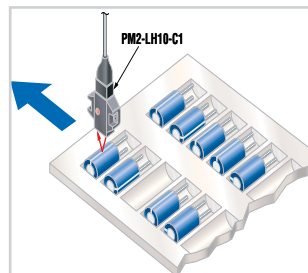

Photoelectric Sensors

Fiber-optic Sensors

Standard Fibers

Fiber Sensors Communication Units

Mark Sensors

Laser Sensors

Safety Sensors

Pressure & Flow Sensors

Inductive Proximity Sensors

Measurement Sensors

Ionizers / Electrostatic Sensors

Accessories



Index

Miniature Sensors

PM2

## Technical specifications

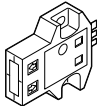
- Fiber-optic Sensors
- Standard Fibers
- Fiber Sensors Communication Units
- Mark Sensors
- Laser Sensors
- Safety Sensors
- Pressure & Flow Sensors
- Inductive Proximity Sensors
- Measurement Sensors
- Ionizers/ Electrostatic Sensors
- Accessories
- Index
- Miniature Sensors
- PM2

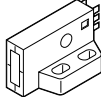
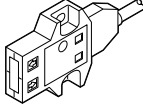
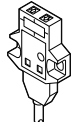
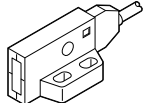
Type	Appearance	Model no.
Connector type	Top sensing 	PM2-LH10
		PM2-LH10B
	Front sensing 	PM2-LF10
		PM2-LF10B
	L type (Top sensing) 	PM2-LL10
		PM2-LL10B
Cable type	Top sensing 	PM2-LH10-C1
		PM2-LH10B-C1
	Front sensing 	PM2-LF10-C1
		PM2-LF10B-C1
	L type (Top sensing) 	PM2-LL10-C1
		PM2-LL10B-C1

Type	Connector type			Cable type			
	Top sensing	Front sensing	L type (Top sensing)	Top sensing	Front sensing	L type (Top sensing)	
Model no.	Light-ON	PM2-LH10	PM2-LF10	PM2-LL10	PM2-LH10-C1	PM2-LF10-C1	PM2-LL10-C1
	Dark-ON	PM2-LH10B	PM2-LF10B	PM2-LL10B	PM2-LH10B-C1	PM2-LF10B-C1	PM2-LL10B-C1
Sensing range	2.5 to 8mm (conv. point: 5mm) with white non-glossy paper (15x15mm)						
Minimum sensing object	Ø 0.05mm copper wire (setting distance: 5mm)						
Repeatability (perpendicular to sensing axis)	0.08mm						
Supply voltage	5 to 24V DC ± 10%						
Output	NPN open-collector transistor, max. 50mA						
Response time	0.8ms or less						
Emitting element	Infrared LED						
Connection method	Connector for soldering (Note)			Cable, 1m			

Note: Cable is not included in delivery. Please select under accessories (page 125).



# EQ-500

Long range sensing capability up to 2.5m

- Photoelectric Sensors
- Fiber-optic Sensors
- Standard Fibers
- Fiber Sensors Communication Units
- Mark Sensors
- Laser Sensors
- Safety Sensors
- Pressure & Flow Sensors
- Inductive Proximity Sensors
- Measurement Sensors
- Ionizers / Electrostatic Sensors
- Accessories
- Index
- Trigonometric Sensors
- EQ-500

## Features

### ■ Impervious to variations in color or angle

Due to its advanced optical system, the sensor is not affected by variations in the object's angle or gloss as compared to conventional sensors. Moreover, sensing can be performed at a somewhat constant distance even if the sensing object is black or white.

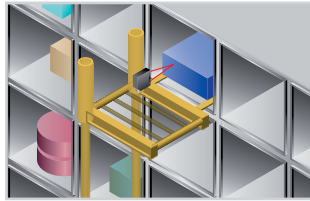

### ■ Not affected by background objects

Due to the 2-segment photodiode adjustable range system, the sensor does not detect objects outside the preset sensing field. It will not malfunction even if someone walks behind the sensing object, or machines or conveyors are in the background.

### ■ An easy-to-set adjuster with indicator

Equipped with a 2-turn adjuster with indicator making it easy to set for short or long distances. **EQ-500** series can function with 24 to 240V AC and 12 to 240V DC. Therefore, almost any power supply anywhere in the world will work.

### ■ Equipped with BGS/FGS function

We have added a DC-voltage type with NPN and PNP transistor outputs, all in one sensor. Its BFS/FGS function controls any background effects for more stable sensing.

### ■ Convenient timer function models

Types with an ON-delay/OFF-delay timer available. (EQ-5□T)

- Operation: ON-delay OFF-delay
- Timer period: 0.1 to 5s (individual setting possible)

### ■ Little affected by contamination on lens

Even if the lens surface gets somewhat dirty from dust particles, there is very little change in the operation field, rendering stable and consistent detection even for particles appearing close to the front surface of the unit.

### ■ Convenient terminal block type

Cabling is enabled by way of a terminal block.

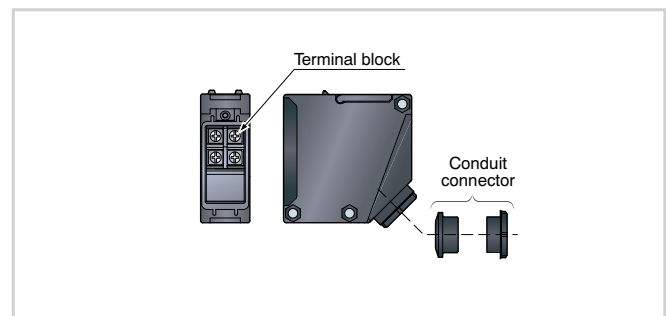
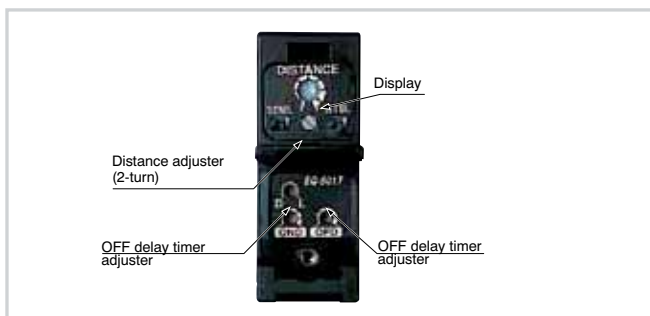

## Technical specifications

- Photoelectric Sensors
- Fiber-optic Sensors
- Standard Fibers
- Fiber Sensors Communication Units
- Mark Sensors
- Laser Sensors
- Safety Sensors
- Pressure & Flow Sensors
- Inductive Proximity Sensors
- Measurement Sensors
- Ionizers / Electrostatic Sensors
- Accessories
- Index
- Trigonometric Sensors
- EQ-500

Type	Multi-voltage type				DC-voltage			
	With timer		With timer		With timer		With timer	
Model no.	EQ-501	EQ-501T	EQ-502	EQ-502T	EQ-511	EQ-511T	EQ-512	EQ-512T
<b>Sensing range</b>	0.2 to 2.5m		0.2 to 1.0m		0.2 to 2.5m		0.2 to 1.0m	
<b>Supply voltage</b>	24 to 240VAC ±10%, or 12 to 24VDC ±10%				12 to 24VDC ±10%			
<b>Output</b>	Relay contact 1a 3A/250VAC				PNP / NPN open-collector transistor, max. 100mA			
<b>Output operation</b>	Light-ON or Dark-ON							
<b>Response time</b>	20ms or less (for EQ-50□T dependent on the setting timer period)				20ms or less (for EQ-51□T dependent on the setting timer period)			
<b>Timer periods</b>	–	Incorporated with variable ON-delay / OFF-delay timer (0.1 to 5s)	–	Incorporated with variable ON-delay / OFF-delay timer (0.1 to 5s)	–	Incorporated with variable ON-delay / OFF-delay timer (0.1 to 5s)	–	Incorporated with variable ON-delay / OFF-delay timer (0.1 to 5s)
<b>Protection</b>	IP67 (IEC)							
<b>Ambient temperature</b>	–20 to +55°C							
<b>Emitting element</b>	Infrared LED							
<b>Connection method</b>	Convenient terminal block							
<b>Dimensions (HxWxD)</b>	68x26x68mm							
<b>Accessories</b>	Screwdriver, 1 pc.							





# EQ-30

Unaffected by color or material, 2m distance adjustable fixed-focus sensing

## Features

- Not affected by object color or background
- Long sensing range 2m
- Compact size

The EQ-30 saves space since a miniaturized housing of 68x20x40mm (HxWxD) has been designed.

- Two setting distances are possible: EQ-34W

With EQ-34W, two sensing distances, Far (Main) and Near (Sub), can be set. Hence, one sensor can suffice where previously two were required.

- Plug-in connector type (excluding EQ-34W)

The plug-in connector type (M12) of the EQ-30 series can be easily disconnected for replacement.

## Technical specifications

Type		Diffuse	Diffuse/double output
Model no.	NPN	EQ-34 (J) (Note)	EQ-34W
	PNP	EQ-34PN (J)	–
Rated sensing distance		2.0m	
Sensing range		0.1-2m	Near: 0.1-2m Far: 0.2-2m
Detectable target		Transparent and opaque material	
Hysteresis		<10% of measurement	
Response time		2ms or less	
Supply voltage		10 to 30VDC ± 10%	
Output		PNP / NPN open-collector transistor, max. 100mA	
Emitting element		Infrared LED	
Rated current consumption without load		NPN type: 50mA PNP type: 55mA	2 x NPN type: 90mA
Material		Plastic	
Protection		IP67 (IEC)	
Ambient temperature		-20 to +55°C	
Connection method		Cable 2m or M12 connector	
Dimensions (HxWxD)		68x20x40mm	
Accessories		Screwdriver, 1 pc.	

Note: Suffix J = M12 connector type

## Typical applications

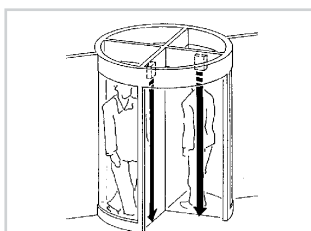

Long distance sensing

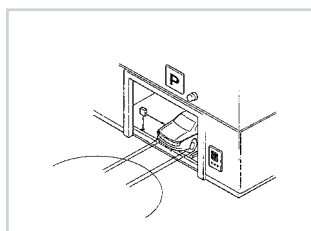

Object detection

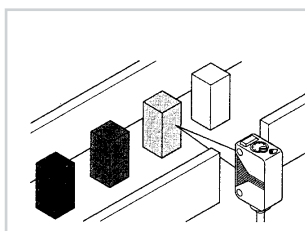

Color-independent detection

Photoelectric Sensors

Fiber-optic Sensors

Standard Fibers

Fiber Sensors Communication Units

Mark Sensors

Laser Sensors

Safety Sensors

Pressure & Flow Sensors

Inductive Proximity Sensors

Measurement Sensors

Ionizers / Electrostatic Sensors

Accessories

Index

Trigonometric Sensors

EQ-30

- Photoelectric Sensors
- Fiber-optic Sensors
- Standard Fibers
- Fiber Sensors Communication Units
- Mark Sensors
- Laser Sensors
- Safety Sensors
- Pressure & Flow Sensors
- Inductive Proximity Sensors
- Measurement Sensors
- Ionizers/ Electrostatic Sensors
- Accessories
- Index
- Trigonometric Sensors
- MQ-W



# MQ-W

**Very accurate detection by triple beam triangulation sensing method in a compact package**

## Features

### ■ Accurate detection

Regardless of color, material, or shape of objects the area reflective type sensor **MQ-W** can detect white or black objects at the same distance.

### ■ No-miss operation regardless of backgrounds

Area reflective type sensors do not detect objects beyond the set range.

### ■ Resistant to lens surface soiling

Area reflective type sensors detect the distance by the angle, not the intensity of received light. Even if the lens surface is soiled by dust or powdery material, there is little variation in sensing range.

## Technical specifications

Type		Diffuse		
Model no.	NPN	MQ-W3A(R) (Note)	MQ-W20A(R)	MQ-W70A1224EMJ
	PNP	MQ-W3C(R)	MQ-W20C(R)	MQ-W70C1224EMJ
<b>Sensing range</b>		40mm	200mm	700mm
<b>Adjustable range</b>		20-40mm	40-200mm	200-700mm
<b>Detectable target</b>		Transparent and opaque material		
<b>Hysteresis</b>		< 10% of measurement range		< 20% of measurement range
<b>Detection frequency</b>		250Hz		
<b>Response time</b>		2ms or less		
<b>Supply voltage</b>		9 to 30VDC		
<b>Output</b>		PNP / NPN open-collector transistor, max. 100mA		
<b>Emitting element</b>		Infrared LED; Type R: Red LED		Infrared LED
<b>Rated current consumption without load</b>		Max. 30mA		
<b>Material</b>		Zinc die cast		
<b>Protection</b>		IP67 (IEC)		
<b>Ambient temperature</b>		-25 to +55°C		
<b>Connection method</b>		Cable, 2m		
<b>Dimensions (HxWxD)</b>		32x12.6x32mm		52x18.6x52mm
<b>Accessories</b>		Mounting brackets, 1 set		

Note: Suffix R = Red LED

## Typical applications

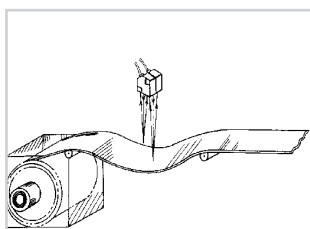

Distance detection

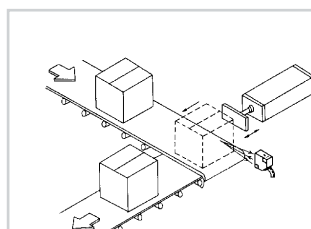

Position detection

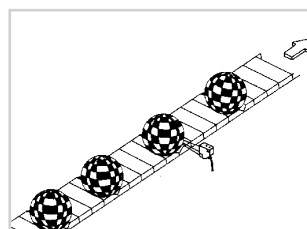

Color-independent detection



# NA1-11

**Cross-beam scanning system to detect slim objects**

## Features

- **Letters, postcards can be detected**  
Thin objects can be detected by using the cross-beam scanning system.
- **Beam pitch: 10mm**  
A minimum sensing object size of  $\varnothing 13.5\text{mm}$  is realized by using a beam pitch of 10mm.

- **Long sensing range**  
Though very slim, a wide sensing area of 1m length and 100mm width is realized. It is most suitable for object detection on a wide assembly line or for detecting the dropping of or incursion by small objects whose travel path is uncertain.

- **Clearly visible large indicator**  
A clearly visible large indicator having a 55mm width is incorporated on both the emitter and the receiver.

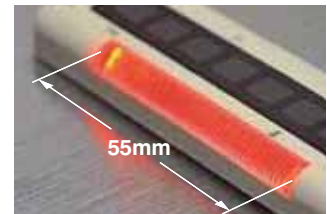
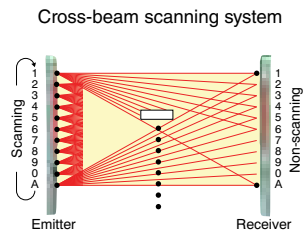

## Typical applications

### Detecting postcards

NA1-11 can detect thin postcards due to its crossbeam scanning system.

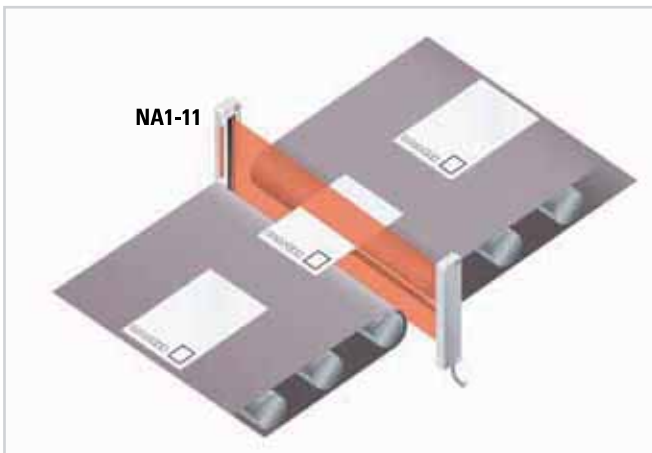

### Detection of haphazardly falling objects

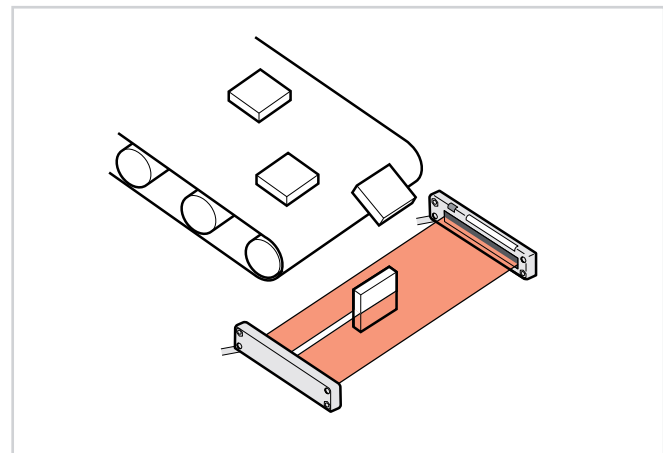

- Photoelectric Sensors
- Fiber-optic Sensors
- Standard Fibers
- Fiber Sensors Communication Units
- Mark Sensors
- Laser Sensors
- Safety Sensors
- Pressure & Flow Sensors
- Inductive Proximity Sensors
- Measurement Sensors
- Ionizers/ Electrostatic Sensors
- Accessories
- Index

- Area Sensors
- NA1-11

## Technical specifications

Type	NPN	PNP
Model no.	NA1-11	NA1-11-PN
Sensing height	100mm	
Sensing range	0.17 to 1m	
Beam pitch	10mm	
Numbers of beam channels	11 each on the emitter and the receiver, respectively	
Object to be sensed	>ø13.5mm; opaque object	
Supply voltage	12 to 24VDC ± 10%	
Output	NPN open-collector transistor, max. 100mA	PNP open-collector transistor, max. 100mA
Ambient temperature	-10 to +55°C	
Connection method	Cable, 2m	
Dimensions (HxWxD)	140x30x10mm	

Fiber-optic Sensors

Standard Fibers

Fiber Sensors Communication Units

Mark Sensors

Laser Sensors

Safety Sensors

Pressure & Flow Sensors

Inductive Proximity Sensors

Measurement Sensors

Ionizers / Electrostatic Sensors

Accessories

Index

Area Sensors

NA1-11

Photoelectric Sensors
Fiber-optic Sensors
Standard Fibers
Fiber Sensors Communication Units
Mark Sensors
Laser Sensors
Safety Sensors
Pressure & Flow Sensors
Inductive Proximity Sensors
Measurement Sensors
Ionizers / Electrostatic Sensors
Accessories
Index

Area Sensors
NA1-PK5 / NA1-PK3

# NA1-PK5 / NA1-PK3

## Pick-to-light sensor – Ultra-slim body

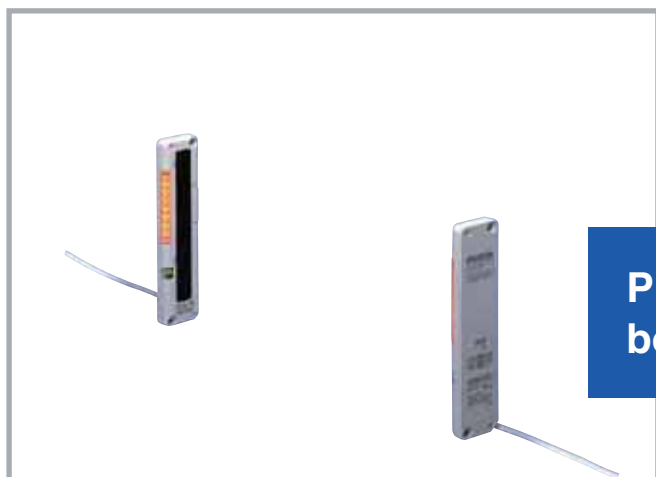

### Features

- 10 mm thick: half the thickness of conventional models

Space saving now possible; ultra-thin design does not obstruct picking operations.

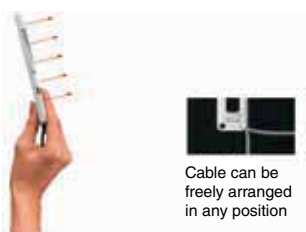

- Two unit installations are possible

Sensor units can now be set to different light emission frequencies in order to prevent mutual interference.

Two units can now be operated in a side-by-side configuration without interference for problem-free detection over wide areas.

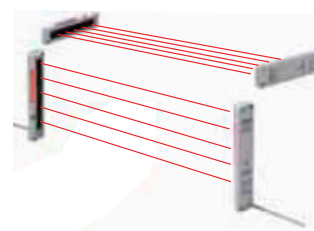

- Lighting pattern selectable

The job indicator operation can be selected as either continuous lighting or blinking.

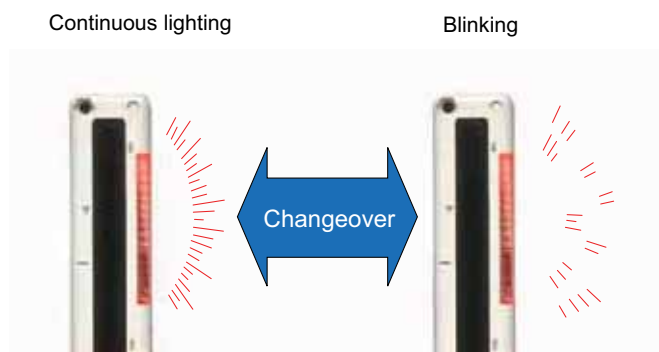

- Selectable detection operation

Sensor units can be set to detect the interruption of 1 beam channel or 2 or more beam channels.

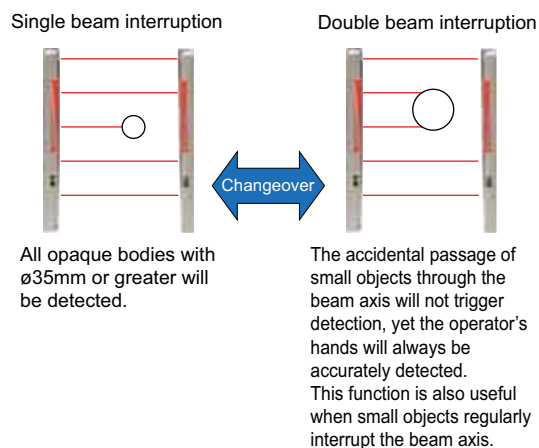

## Typical applications

### Cell production line



### Assembly line

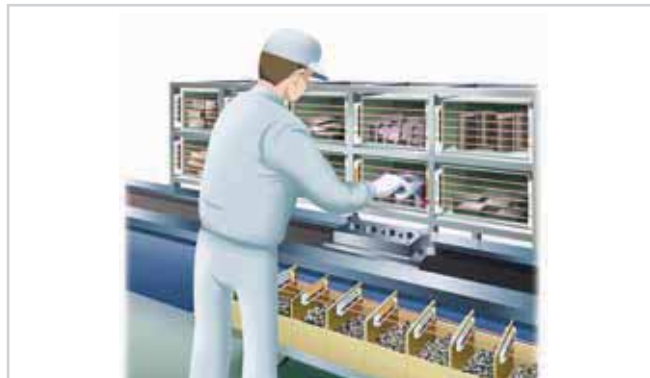

## Technical specifications

Type	NPN		PNP	
Model no.	NA1-PK5	NA1-PK3	NA1-PK5-PNP	NA1-PK3-PNP
Sensing height	100mm	49.2mm	100mm	49.2mm
Sensing range	0.1 to 1.2m	0.03 to 0.3m	0.1 to 1.2m	0.03 to 0.3m
Beam pitch	25mm	24.6mm	25mm	24.6mm
Number of beam channels	5 beam channels	3 beam channels	5 beam channels	3 beam channels
Object to be sensed	> ø35mm, opaque object	> ø29mm, opaque object	> ø35mm, opaque object	> ø29mm, opaque object
Supply voltage	12 to 24V DC ± 10%			
Output	NPN open-collector transistor max.100mA		PNP open-collector transistor max.100mA	
Connection method	Cable, 2m			
Dimensions (HxWxD)	140x30x10mm	70x24x8mm	140x30x10mm	70x24x8mm





# FX-100

Excellent price/performance ratio

## Features

### ■ Easy to read

The digital dual display allows you to check both the threshold value and incident light intensity at the same time. It also makes the procedures for setting the various values much easier.

### ■ Multipurpose M8 connector type

The connectors used are commercially available M8 connectors, so that processing costs and lead time required for carrying out processing can be greatly reduced.

### ■ Designed in a 3-layer structure to accommodate basic through advanced settings

Setting details are divided into three levels for clearer operation, so that settings for normal operation are made in 'RUN mode', basic settings are made in 'SET mode', and advanced functions are set in 'PRO mode'. This makes setting operations much easier to understand and carry out.

## Typical applications

### Wafer detection

Detects wafer carrier cases through vacuum chamber's view port.

### Wafer detection

Sensing possible in corrosive environment. Lenses at the ends of the fiber heads expand the sensing range.

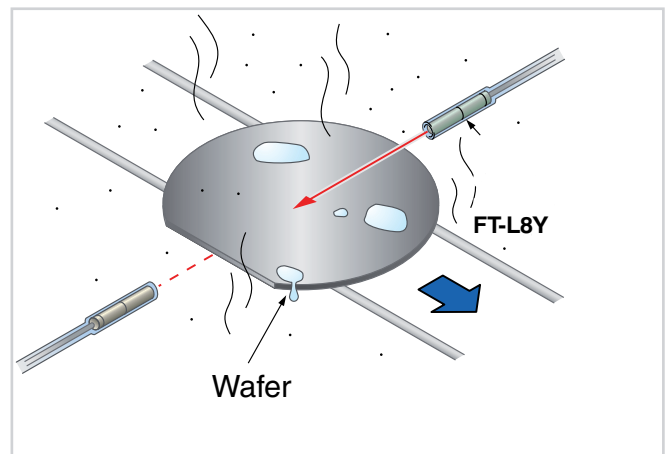
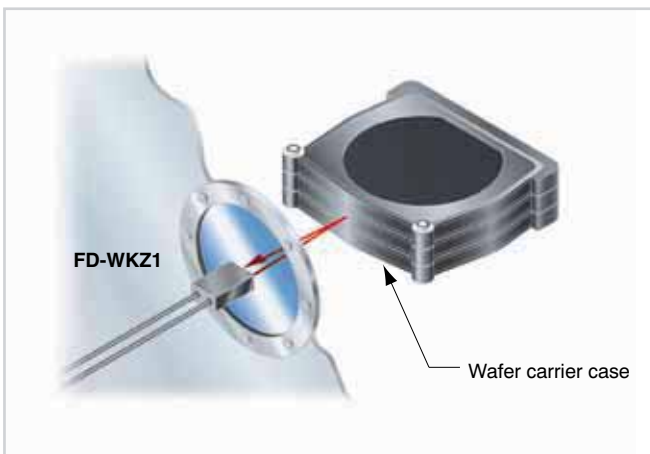



### Detection of breaks / cracks of glass

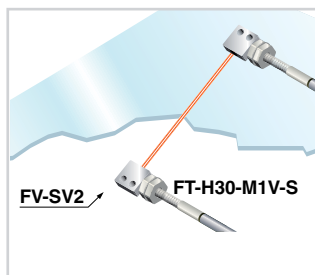

### Detection over long ranges

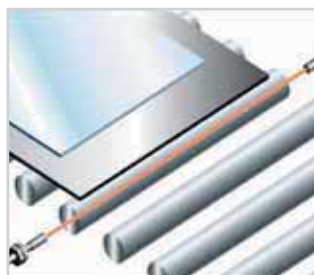

### Detection of glass substrate in vacuum chamber

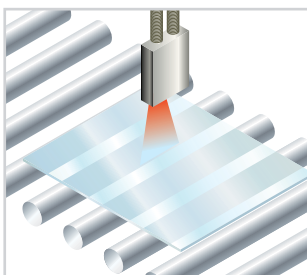

### Detection of glass substrate on robot hand

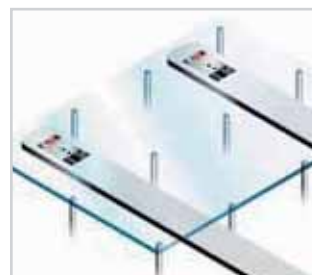

## Technical specifications

Type		Standard type		Long sensing range	
		Connector type	Cable type	Connector type	Cable type
Model no.	NPN	FX-101 (-Z) (Note 2)	FX-101-CC2	FX-102 (-Z) (Note 2)	FX-102-CC2
	PNP	FX-101P (-Z) (Note 2)	FX-101P-CC2	FX-102P (-Z) (Note 2)	FX-102P-CC2
Supply voltage		12 to 24V DC $\pm 10\%$			
Power consumption		Normal operation: 720mW or less (current consumption 30mA or less at 24V supply voltage) Eco mode: 600mW or less (Current consumption 25mA or less at 24V supply voltage)			
Response time		Response time 0: 250 $\mu$ s or less Response time 1: 450 $\mu$ s or less Response time 2: 500 $\mu$ s or less Response time 3: 600 $\mu$ s or less		Response time 1: 2.5ms or less Response time 2: 2.8ms or less Response time 3: 3.2ms or less Response time 4: 5.0ms or less	
Output		PNP / NPN open-collector transistor, max. 100mA			
Output operation		Selectable either Light-ON or Dark-ON			
Short-circuit protection		Incorporated			
Sensitivity setting		2-level teaching/Limit teaching/Full-auto teaching			
Digital display		4 digit green + 4 digit red LCD display			
Timer function		ON-delay /OFF-delay, switchable either effective or ineffective. [Timer period:1ms, 5ms, 10ms, 20ms, 40ms, 50ms, 100ms, 500ms, 1000ms]			
Interference prevention		Incorporated Selectable response time method (Note 1) (Functions at response time 1, 2 or 3)		Incorporated Selectable response time method (Note 1) (Functions at response time 1, 2, 3 or 4)	
Ambient temperature		-10 to +55°C (if 4 to 7 units are mounted close together: -10 to +50°C; if 8 to 16 units are mounted close together: -10 to +45°C (no dew condensation or icing allowed);			
Emitting element		Red LED			
Material		Enclosure: polycarbonate; key switch: polycarbonate; fiber lock lever: PBT			
Connection method		Small connector M8 connector (Note 3)	Cable, 2m	Small connector M8 connector (Note 3)	Cable, 2m
Dimensions (HxWxD)		32x9x66.4mm			
Accessories		—	CN-14A-C2 (Connector attached cable: 2m): 1 pc.	—	CN-14A-C2 (Connector attached cable: 2m): 1 pc.

#### Notes:

- When using the interference prevention function, set the emission frequencies for the amplifiers to be covered by the interference prevention function to different frequency values. However, the interference prevention function does not operate at emission frequency 0 (factory default setting) for the **FX-101(P)(-Z)/FX-101(P)-CC2**.
- Suffix -Z = M8 connector type
- The cable is not included in delivery. Please select under accessories (page 125).

Photoelectric  
Sensors

Fiber-optic  
Sensors

Standard Fibers

Fiber Sensors  
Communication  
Units

Mark Sensors

Laser Sensors

Safety Sensors

Pressure & Flow  
Sensors

Inductive Proximity  
Sensors

Measurement  
Sensors

Ionizers/  
Electrostatic  
Sensors

Accessories

Index

FX-100

- Photoelectric Sensors
- Fiber-optic Sensors**
- Standard Fibers
- Fiber Sensors Communication Units
- Mark Sensors
- Laser Sensors
- Safety Sensors
- Pressure & Flow Sensors
- Inductive Proximity Sensors
- Measurement Sensors
- Ionizers/ Electrostatic Sensors
- Accessories
- Index



# FX-301

**Enhanced functions**  
 - strong performance  
 - easy to use

## Features

■ **FX-301(P) (red LED type) version upgrade**  
 We improved the standard model by enhancing its sensing stability and equipping it with handy functions such as the light-emitting amount selection function.

■ **Super high speed response of 35μs**  
 The **FX-301(P)-HS** model is the digital type fiber sensor realizing a super high speed response of 35μs rendering it capable of sensing minute objects moving at high speeds.

■ **Stable sensing over long and short periods**  
 In addition to a four-chemical emitting element which suppresses changes in the light-emitting element over time so that a stable level of light emission can be maintained over long periods, a new APC (Auto Power Control) circuit has also been adopted. Because fluctuations over short periods of time have also been suppressed, stable sensing is possible very quickly once the power is turned back on after setup changes.

■ **Sensing range has been greatly increased**  
 All models use a double coupling lens that enables a much wider sensing range and maximization in the light emission efficiency. Sensing ranges with small diameter fibers and ultra small diameter fibers, which have become very popular due to the miniaturization of chip components, have been increased by 50% over previous values achieved with other amplifiers.

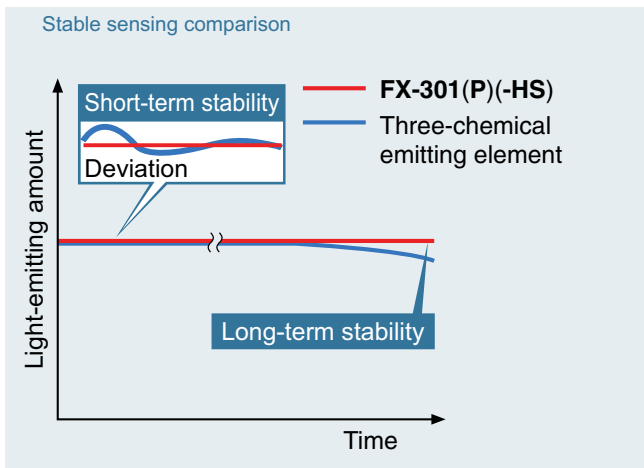
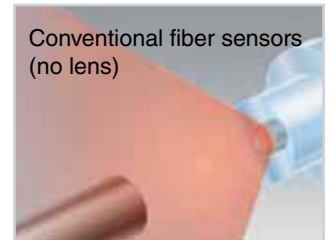
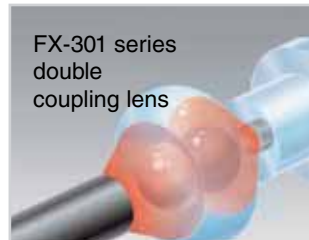

FX-301

# Typical applications

## Workpiece detection

This standard type of FX-301(P)(-HS) using red light has a four-chemical emitting element for stable sensing over long periods.

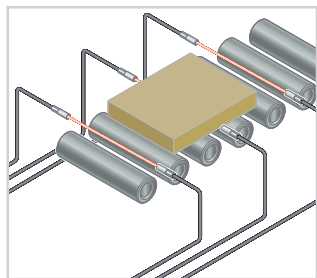

## Object sensing during the painting process

Due to a sensing range of 19.5m (FX-301 long range mode) and a 10m fiber length, it can be lead through rough environments freely.



## Sensing translucent stickers

The blue LED type greatly reduces the damping rate, making it ideal for delicate sensing for yellow/red transitions.



## Engine block passage confirmation

FD-WKZ1 has realized a sensing range of 480mm (FX-301 long range mode). In addition, due to its powerful beam, it can even work in adverse environments such as in areas prone to dust.

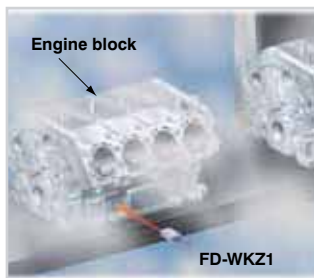

## Register mark detection

The green LED type greatly reduces the damping rate, making it ideal for delicate sensing.

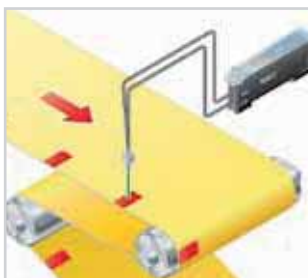

## Wire breakage detection

Wide beams are ideal for moving wire detection.

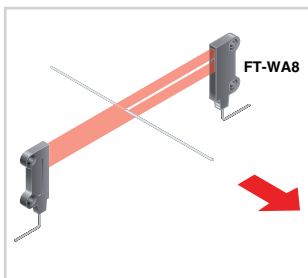

## Sensing film meandering

Infrared LED type is ideal for sensing environments with light restrictions, such as places where light-sensitive film is being handled.



# Technical specifications

Type		Standard type	High speed
Model no.	NPN	FX-301( /-B/-G/-H) (Note 1)	FX-301-HS
	PNP	FX-301( /-B/-G/-H)P	FX-301P-HS
Supply voltage		12 to 24VDC ±10%	
Response time		65µs or less H-SP (Red LED type only); 150µs or less (FAST); 250µs or less (STD/S-D (red LED type only)); 2ms or less (LONG) selectable with jog switch	35µs or less (H-SP); 150µs or less (FAST); 250µs or less (STD/S-D); 2ms or less (LONG) selectable with jog switch
Output		PNP / NPN open-collector transistor, max. 100mA	
Output operation		Selectable either Light-ON or Dark-ON, with jog switch	
Sensitivity setting		2-level teaching/Limit teaching/ Full-auto/ teaching	
Digital display		4-digit red LED display	
Automatic interference prevention function		Incorporated (Up to 4 sets of fiber heads can be mounted close together.) (However, H-SP mode is 2 sets.)	
Ambient temperature		-10 to +55°C	
Emitting element		FX-301(P): Red LED, FX-301B(P): Blue LED, FX-301G(P): Green LED, FX-301H(P): Infrared LED	Red LED
Connection method		Connector (Note 2)	
Dimensions (HxWxD)		30.5x10x64.5mm	
Accessories		FX-MB1 Amplifier protection seal	

### Notes:

- Without suffix = Red LED  
Suffix -B = Blue LED  
Suffix -G = Green LED  
Suffix -H = Infrared LED
- The cable for amplifier connection is not supplied as an accessory. Please select under PC-12-2012 (page 125).

Photoelectric Sensors

Fiber-optic Sensors

Standard Fibers

Fiber Sensors Communication Units

Mark Sensors

Laser Sensors

Safety Sensors

Pressure & Flow Sensors

Inductive Proximity Sensors

Measurement Sensors

Ionizers / Electrostatic Sensors

Accessories

Index

FX-301



# FX-311

Remarkably easy to use, yet employs the latest in technology

## Features

### 12-turn potentiometer with visible indicator

12-turn potentiometer has been incorporated for fine adjustments. It enables very fine differences to be detected. Since the potentiometer is illuminated, you can even make adjustments easily in dark areas.

### Three light source types (red, green, blue) are made available for expanding applications

Rapid blinking 'assist function' eases adjustment for optimum sensitivity.

## Typical applications

### Detecting transparent PET bottles

The green LED type is ideal for stably sensing objects such as transparent bottles which yield only small amounts of light fluctuation.

### Register mark detection

The blue LED type can accurately sense yellow marks on white backgrounds that are difficult to sense using the red LED type.

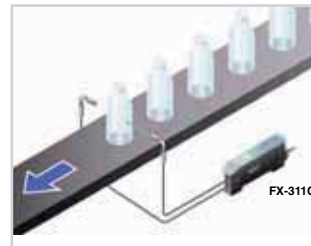

## Technical specifications

Model no.	NPN	FX-311
	PNP	FX-311P
Supply voltage	12 to 24V DC $\pm 10\%$	
Power consumption	840mW or less (Current consumption 35mA or less at 24V supply voltage)	
Response time	250 $\mu$ s or less (STD / S-D), 2ms or less (LONG) selectable with selection switch	
Output	PNP / NPN open-collector transistor, max. 100mA	
Output operation	Selectable either Light-ON or Dark-ON, with selection switch	
Short-circuit protection	Incorporated	
Operation of indicators	Orange LED (lights up when the output is ON)	
Timer function	Incorporated with OFF-delay timer, selectable either effective (approx. 10ms or 40ms) or ineffective	
Automatic interference prevention function	Incorporated (Up to 4 sets of fiber heads can be mounted closely.) (Note 1)	
Ambient temperature	-10 to +55°C (if 4 to 7 units are mounted close together: -10 to +50°C; if 8 to 16 units are mounted close together: -10 to +45°C (no dew condensation or icing allowed);	
Emitting element	Red LED	
Material	Enclosure: Heat-resistant ABS, Case cover: polycarbonate	
Connection method	Connector (Note 2)	
Dimensions (HxWxD)	34.5x10x70.5mm	

### Notes:

- When the power supply is switched on, the light emission timing is automatically set for interference prevention.
- The cable for amplifier connection is not supplied as an accessory. Please select under accessories (page 125).

# FX-500



Fiber amplifier at the industry's leading edge

Photoelectric Sensors

Fiber-optic Sensors

Standard Fibers

Fiber Sensors Communication Units

Mark Sensors

Laser Sensors

Safety Sensors

Pressure & Flow Sensors

Inductive Proximity Sensors

Measurement Sensors

Ionizers / Electrostatic Sensors

Accessories

Index

FX-500

## Features

### Optimized stability

When used with the super quality fiber as a set, the incident light intensity variation among units is decreased to only 1/4 of that of conventional models.

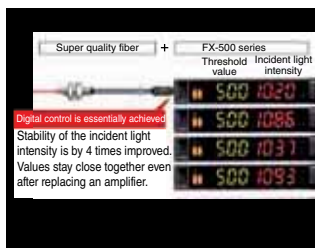

### High performance

The FX-500 with its ultra high response time improves of 25µs productivity.



### HYPER mode incorporated

FX-500 in combination with the small diameter fiber can handle challenging detections over a super long sensing range.



### Improved accuracy!

FX-500 with its accurate detection catches fractional difference in light intensity, fulfilling high precision and low-hysteresis applications.

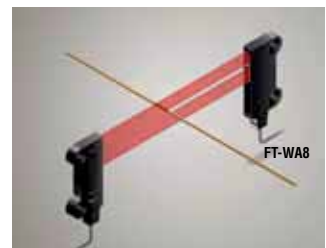

■ No PLC necessary, saving material and programming costs

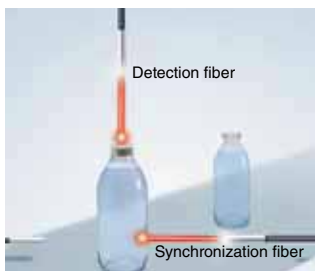

### Logical operation of sensors

Three logical calculations (AND/OR/XOR) are selectable using Output 1 of multiple FX-500 series amplifiers. You can logically connect two outputs of an FX-500 or one input of a normal sensor to the output of an FX-500 sensor.

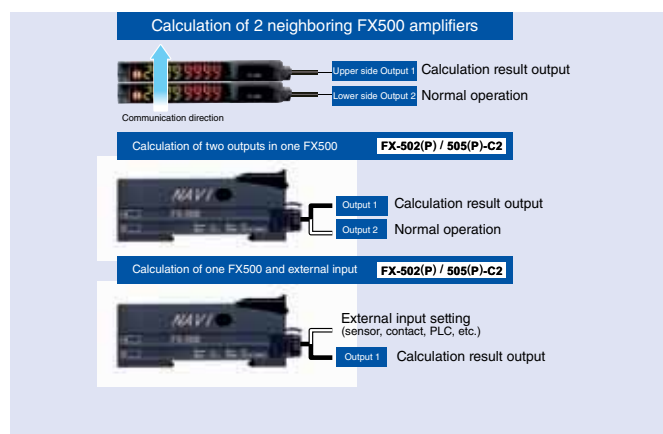

■ Analog output cable type FX-505

The sensor outputs an analog signal of 4-20mA in proportion to digital value displayed for the current light intensity received.

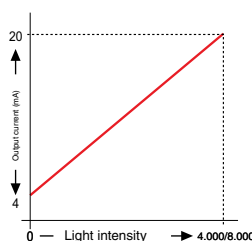

Edge tracking of film or sheet

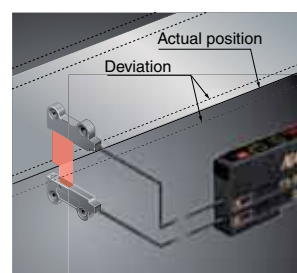

Drifting path can be tracked as the light intensity changes.

## Typical applications

Photoelectric Sensors

Fiber-optic Sensors

### Counting of IC pins

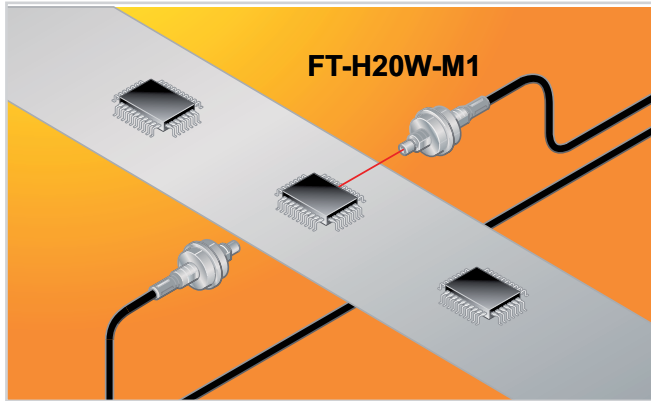

### Check crimping

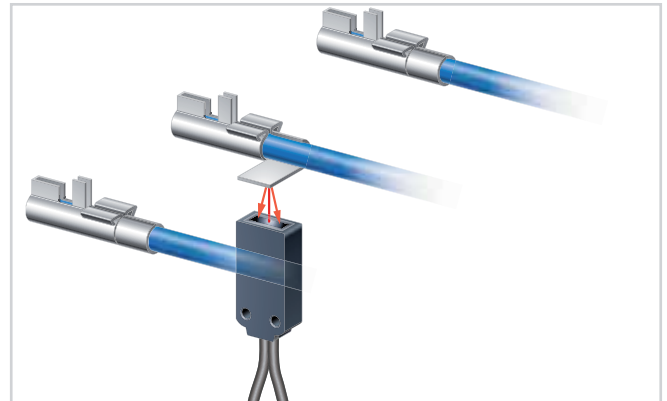

### Glass substrate sensing



## Technical specifications

Type	Standard type		2 outputs	Analog output type
Model no.	NPN	FX-501	FX-502	FX-505-C2
	PNP	FX-501P	FX-502P	FX-505P-C2
Digital fiber sensor amplifier	Digital			Analog
Timer function	Adjustable: 0.1ms to 999.9ms in 0.1ms steps, 1 to 9999ms in 1ms steps, 1 to 32s in 1s steps			
Interference prevention	Auto interference prevention function for up to 12 units and selectable emission frequency method			
Response time	25μs/60μs/250μs/2ms/4ms/24ms or less			
Analog voltage output	-			4 to 20mA
Supply voltage	12 to 24VDC ±10%			
Output	PNP / NPN open-collector transistor, max. 100mA			
Emitting element	Red LED			
Material	Enclosure: polycarbonate, switch: POM			
Rated current consumption (without load)	Normal operation: 40mA or less at 24V supply voltage Eco mode: 30mA or less at 24V supply voltage			
Protection	IP40 (IEC)			
Ambient temperature	-10 to +55°C			
Connection method	Connector (Note)			Cable, 2m
Dimensions (HxWxD)	34x10x75mm			
Accessories	FX-MB1 Amplifier protection seal			

**Note:**

The cable for amplifier FX-501□, FX-502□ is not supplied as an accessory. Please select under accessories (page 125).

# Fiber-optic Sensors

Now with communication interface!



## Fibers with integrated high-precision plug

### Stable light intensity

Optical **fibers** with insertion plug-in achieve a very high quality standard. Through the integrated high-precision plug, the fiber core can be centered to within  $\pm 40\mu\text{m}$ . Variation in light intensity could thus be reduced to  $\pm 10\%$ .



### New fiber core

Now the core consists of only one fiber instead of several single fibers. This design improves sensing stability dramatically because there is no variation in light intensity among individual fibers.



### Sharp bending and flexible fibers

With a bending radius of 4mm, the optical fibers easily cope with millions of bending cycles.



## Super Quality

It is a fiber with superior light intensity stability and simple digital management when combined with the FX-500 series amplifier. It offers stable sensing with an extremely small beam axis curvature and gap.

### Digital management is simple due to small differences in body.

When combined with the **FX-500** series amplifiers, it has up to 4 times improved stability of incident light intensity compared with traditional fibers. Management is simple even when replacing amplifiers because the digital display shows the approximate value.

Super quality fiber

+

FX-500 series



"Stabilized incident light intensities" even in multiple units





## Thru-beam type (one pair set)

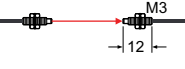
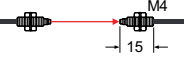

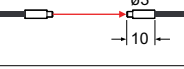
Type	Shape of fiber head (mm)	Model no.	Bending radius	Fiber cable length	Sensing range (mm)			Beam axis dia. (mm)	Protection	Ambient temperature
					FX-500 series	U-LG LONG FAST H-SP	FX-101 FX-102			
Threaded	M3 	<b>Tough</b> FT-30	R2	2m	STD 400 HYPR 1,350	810 650 210 75	135 400	ø0.5	IP67 (IEC)	-55 to +80°C
	M4 	<b>Tough</b> FT-40	R4		STD 1,200 HYPR (Note) 3,600	2,200 1,700 530 190	320 870	ø1		
Cylindrical type	ø1.5 	<b>Tough</b> FT-S20	R2		STD 400 HYPR 1,350	810 650 210 75	135 400	ø0.5		
	ø3 	<b>Tough</b> FT-S30	R4		STD 1,200 HYPR (Note) 3,600	2,200 1,700 30 190	320 870	ø1		

Note: The length of the fiber cable affects the sensing range.

## Reflective type

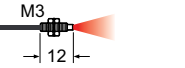
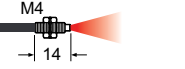
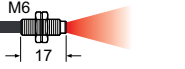
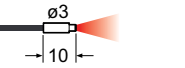

Type	Shape of fiber head (mm)	Model no.	Bending radius	Fiber cable length	Sensing range (mm) (Note)			Protection	Ambient temperature
					FX-500 series	U-LG LONG FAST H-SP	FX-101 FX-102		
Threaded	M3 	<b>Tough</b> FD-30	R2	2m	STD 160 HYPR 600	330 250 80 25	45 155	IP67 (IEC)	-55 to +80°C
	M4 	<b>Tough</b> FD-40							
	M6 	<b>Tough</b> FD-60	R4						
Cylindrical	ø3 	<b>Tough</b> FD-S30			STD 160 HYPR 600	330 250 80 25	45 155		

Note: The sensing range is specified for white, matt paper.

**Tough** High flexibility: min. bending radius of 4mm, 10 mio. bending cycles (@ radius 10mm)

Photoelectric Sensors

Fiber-optic Sensors

Standard Fibers

Fiber Sensors Communication Units

Mark Sensors

Laser Sensors

Safety Sensors

Pressure & Flow Sensors

Inductive Proximity Sensors

Measurement Sensors

Ionizers/ Electrostatic Sensors

Accessories

Super quality fibers

# Standard Fibers

## Threaded fibers

### Thru-beam type (one pair set)

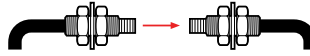

Type	Shape of fiber head (mm)	Model no.	Bending radius	Fiber cable length	Sensing range (mm) (Note 1)			Beam axis dia. (mm)	Protection	Ambient temperature
					FX-500 series	U-LG LONG FAST H-SP	FX-101 FX-102			
M3		<b>Tough</b> FT-31	R2		STD 315 HYPR 1,350	770 550 210 70	130 340	ø0.5		-55 to +80°C
		FT-31W	R1		STD 260 HYPR 990	590 440 150 53	80 240			-40 to +60°C
M4		Lens mountable: FX-LE1, FX-LE2, FX-SV1 FT-43	R4	2m	STD 1,400 HYPR (Note 2) 3,600	2,800 2,100 770 240	350 970	ø1.5		-55 to +80°C
		<b>Tough</b> FT-42			STD 1,130 HYPR (Note 2) 3,600	2,050 1,600 530 190	30 800			
	Lens mountable: FX-LE1, FX-LE2, FX-SV1 FT-42W	R1	STD 800 HYPR 3,300	1,900 1,400 490 160	260 720	-40 to +60°C				
	Lens mountable: FX-LE1, FX-LE2, FX-SV1 FT-45X	R4	1m	STD 1,200 HYPR (Note 2) 1,600	1,600 (Note 2) 1,600 (Note 2) 630 200	340 920	ø1		-55 to +80°C	
	Elbow FT-R40	R4	STD 930 HYPR (Note 2) 3,600	1,750 1,500 500 160	270 740					
Square head W7 × H9 × D13.9		FT-R41W	R1	2m	STD 800 HYPR (Note 2) 3,200	1,800 1,400 460 150	250 710	ø2.2		-40 to +60°C
		With expansion lens FT-R42W			STD 2,200 HYPR (Note 2) 3,600	3,600 (Note 2) 3,500 1,300 460	510 2,000			
M14 Long sensing range		<b>Tough</b> FT-140	R4	10m	STD (Note 2) 19,600 HYPR (Note 2) 19,600	19,600 (Note 2) 19,600 (Note 2) 16,000 6,300	14,000 19,600 (Note 2)	ø10		-40 to +70°C

#### Notes:

- 1) The sensing range of the free-cut type fiber may be reduced depending upon how the fiber is cut.
- 2) The length of the fiber cable affects the sensing range.

**Tough** High flexibility: min. bending radius of 4mm, 10 mio. bending cycles (@ radius 10mm)

## Reflective type



Type	Shape of fiber head (mm)	Model no.	Bending radius	Fiber cable length	Sensing range (mm) (Note 1, 2)			Protection	Ambient temperature
					FX-500 series	U-LG LONG FAST H-SP	FX-101 FX-102		
M3		<b>Tough</b> FD-31	R2	2m	STD 125 HYPR 515	290 220 80 25	35 140	IP67 (IEC)	-55 to +80°C
		FD-31W	R1		STD 80 HYPR 330	180 140 45 12	15 60		-40 to +60°C
		<b>Tough</b> FD-32G	R2		STD 200 HYPR 650	380 270 95 27	70 190	IP40 (IEC)	-55 to +80°C
		FD-32GX	R2	STD 200 HYPR 630	410 360 100 30	75 210	-55 to +80°C		
		FD-EG30	R4	500mm	STD 48 HYPR 170	130 110 30 9	20 70		-40 to +70°C
		FD-EG31			STD 20 HYPR 85	45 35 12 3.5	7 25		-20 to +60°C
Threaded M4		<b>Tough</b> FD-41	R2	2m	STD 125 HYPR 515	290 220 80 25	35 140	IP67 (IEC)	-55 to +80°C
		FD-41W	R1		STD 270 HYPR 900	630 430 150 45	80 230		-40 to +60°C
		<b>Tough</b> FD-42G	R2		STD 200 HYPR 650	380 270 95 27	70 190	-55 to +80°C	
		FD-42GW	R1		STD 150 HYPR 670	340 280 90 25	45 140	-40 to +60°C	
M6		FD-62	R4	1m	STD 520 HYPR 1,500	1,000 940 340 110	170 450	IP67 (IEC)	-55 to +80°C
		<b>Tough</b> FD-61			STD 450 HYPR 1,400	840 670 200 70	120 410		-55 to +80°C
		FD-61W	R1		STD 270 HYPR 900	630 430 150 45	80 230		-40 to +60°C
		<b>Tough</b> FD-61G	R4		STD 420 HYPR 1,100	800 650 200 60	120 350	IP40 (IEC)	-55 to +80°C
		FD-64X	R4		STD 280 HYPR 670	500 410 160 50	75 220		-55 to +80°C
		<b>Tough</b> FD-R60	R4		STD 290 HYPR 1,100	600 550 190 65	110 240		IP67 (IEC)

**Notes:**

- 1) The sensing range of the free-cut type fiber may be reduced depending upon how the fiber is cut.
- 2) The sensing range is specified for white, matt paper.
- 3) The allowable cutting range is 700mm from the end inserted at the amplifier.

**Tough** High flexibility: min. bending radius of 4mm, 10 mio. bending cycles (@ radius 10mm)

Photoelectric Sensors

Fiber-optic Sensors

Standard Fibers

Fiber Sensors Communication Units

Mark Sensors

Laser Sensors

Safety Sensors

Pressure & Flow Sensors

Inductive Proximity Sensors

Measurement Sensors

Ionizers / Electrostatic Sensors

Accessories

Threaded fibers

# Standard Fibers

## Cylindrical fibers

### Thru-beam type (one pair set)



Type	Shape of fiber head (mm)	Model no.	Bending radius	Fiber cable length	Sensing range (mm) (Note 1)			Beam axis dia. (mm)	Protection	Ambient temperature	
					FX-500 series	U-LG LONG FAST H-SP	FX-101 FX-102				
Cylinder type		<b>Tough</b> FT-S11	R2	500mm	STD 210 HYPR 90 350	210 160 60 19	40 90	ø0.25	IP67 (IEC)	-55 to +80°C	
		FT-S21			STD 770 HYPR 315 1,350	770 550 210 70	130 340				
		FT-S21W	R1	2m	STD 590 HYPR 260 990	590 440 150 53	80 240	ø0.5	IP67 (IEC)	-40 to +60°C	
		FT-S32	R10		STD 3,100 HYPR (Note 2) 3,600	3,600 (Note 2) 3,600 (Note 2) 1,800 600	1,100 3,000				
		FT-S31W	R1	1m	STD 1,900 HYPR 800 3,300	1,900 1,400 490 160	260 720	ø1	IP40 (IEC)	-40 to +60°C	
		FT-E13	R2		STD 30 HYPR 15 8 2	30 24 8 2	6 19				
	Ultra-small diameter		FT-E23	R2	2m	STD 160 HYPR 75 270	160 125 42 13	22 80	ø0.25	IP67 (IEC)	-40 to +70°C
			FT-V40	R4		STD 3,500 HYPR (Note 2) 3,600	3,600 (Note 2) 3,600 (Note 2) 2,400 850	1,000 3,100			
	Sidesensing		FT-V40	R4	2m	STD 3,500 HYPR (Note 2) 3,600	3,600 (Note 2) 3,600 (Note 2) 2,400 850	1,000 3,100	ø2.5	IP50 (IEC)	-40 to +60°C

**Notes:**

- 1) The sensing range of the free-cut type fiber may be reduced depending upon how the fiber is cut.
- 2) The length of the fiber cable affects the sensing range.

### Reflective type

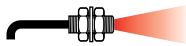

Type	Shape of fiber head (mm)	Model no.	Bending radius	Fiber cable length	Sensing range (mm) (Note 1, 2)			Protection	Ambient temperature
					FX-500 series	U-LG LONG FAST H-SP	FX-101 FX-102		
Cylindrical		FD-S21	R2	1m	STD 130 HYPR 80 190	130 110 37 11	25 70	IP40 (IEC)	-55 to +80°C
		FD-S32	R4		STD 790 HYPR 420 1,200	790 660 220 75	120 345		
		FD-S32W	R1	2m	STD 630 HYPR 270 900	630 430 150 45	80 230	IP67 (IEC)	-40 to +60°C
		FD-S31	R2		STD 290 HYPR 125 515	290 220 80 25	35 140		
		FD-S33GW	R1		STD 340 HYPR 150 670	340 280 90 25	45 140		
	Ultra-small diameter		FD-E13	R4	1m	STD 29 HYPR 12 50	29 25 7 2	5 15	IP40 (IEC)
FD-E23			STD 120 HYPR 55 170			120 80 30 9	20 70		

**Notes:**

- 1) The sensing range of the free-cut type fiber may be reduced depending upon how the fiber is cut.
- 2) The sensing range is specified for white, matt paper.

# Fibers with sleeve

■ Thru-beam type (one pair set)

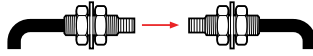

Type	Shape of fiber head (mm)	Model no.	Bending radius	Fiber cable length	Sensing range (mm) (Note 1, 2)			Beam axis dia. (mm)	Protection	Ambient temperature	
					FX-500 series	U-LG LONG FAST H-SP	FX-101 FX-102				
Threaded	M3 	<b>Tough</b> FT-31S	R2	2m	STD 740 HYPR 315 1,220	740 550 195 63	130 340	ø0.5	IP67 (IEC)	-55 to +80°C	
	M4 	<b>Tough</b> FT-42S	R4 (Note 3)		STD 2,050 HYPR 1,130 (Note 2) 3,600	2,050 1,600 530 190	300 800	ø1			
Cylindrical	Ultra-small diameter ø3 	<b>Tough</b> FT-E13	R2	1m	STD 15 HYPR 52	30 24 8 2	6 19	ø0.125	IP67 (IEC)	-40 to +70°C	
		<b>Tough</b> FT-E23			STD 75 HYPR 270	160 125 42 13	22 80	ø0.25			
	Side sensing	ø2 	<b>Tough</b> FT-V23	R4	2m	STD 450 HYPR 1,800	1,000 880 280 90	160 400	ø0.75	IP30 (IEC)	-55 to +80°C
			<b>Tough</b> FT-V25	R2		STD 240 HYPR 900	550 480 140 45	95 260	ø0.5		
Side sensing	ø2.5 	<b>Tough</b> FT-V24W	R1	2m	STD 110 HYPR 380	230 200 60 20	35 90	ø0.5	IP30 (IEC)	-40 to +60°C	
		<b>Tough</b> FT-V30	R4		STD 680 HYPR 2,200	1,200 1,000 340 100	180 480	ø1.0			-55 to +80°C

**Notes:**

- 1) The sensing range of the free-cut type fiber may be reduced depending upon how the fiber is cut.
- 2) The length of the fiber cable affects the sensing range.
- 3) The bending radius of the sleeve is >10mm.

**Tough** High flexibility: min. bending radius of 4mm, 10 mio. bending cycles (@ radius 10mm)

Photoelectric Sensors

Fiber-optic Sensors

Standard Fibers

Fiber Sensors Communication Units

Mark Sensors

Laser Sensors

Safety Sensors

Pressure & Flow Sensors

Inductive Proximity Sensors

Measurement Sensors

Ionizers / Electrostatic Sensors

Accessories

Fibers with Sleeve

# Standard Fibers

## Reflective type



Type	Shape of fiber head (mm)	Model no.	Bending radius	Fiber cable length	Sensing range (mm) (Note 1, 2)			Protection	Ambient temperature	
					FX-500 series	U-LG LONG FAST H-SP	FX-101 FX-102			
Threaded	Ultra-small diameter M3 Sleeve 15mm 	FD-EG30S	R4	1m	STD 50 HYPR 170	110 80 30 9	20 70	IP40 (IEC)	-40 to +70°C	
	M4 Sleeve 40mm 	<b>Tough</b> FD-41S	R2 (Note 3)	2m 	STD 125 HYPR 515	290 220 80 25	35 140	IP67 (IEC)	-55 to +80°C	
	M4 Sleeve 40mm 	FD-41SW	R1 (Note 3)		STD 80 HYPR 330	180 140 45 12	15 60		-40 to +60°C	
	M6 Sleeve 40mm 	<b>Tough</b> FD-61S	R4 (Note 3)		STD 420 HYPR 1,200	790 660 220 75	130 360		-55 to +80°C	
Cylindrical	Ultra-small diameter ø1.5 	FD-E13	R4	1m	STD 12 HYPR 50	29 25 7 2	5 15	IP40 (IEC)	-40 to +60°C	
	ø3 	FD-E23			STD 55 HYPR 170	120 80 30 9	20 70		-40 to +70°C	
	Side sensing	ø3 	<b>Tough</b> FD-V30	R2	2m 	STD 65 2,559 HYPR 240	130 120 35 14	25 75	IP30 (IEC)	-55 to +80°C
		ø3 	FD-V30W	R1		STD 20 HYPR 80	40 30 10 2	6 20		-40 to +60°C
		ø5 	<b>Tough</b> FD-V50	R4		STD 120 HYPR 370	220 210 75 25	40 100		-55 to +80°C

### Notes:

- 1) The sensing range of the free-cut type fiber may be reduced depending upon how the fiber is cut.
- 2) The sensing range is specified for white, matt paper.
- 3) The bending radius of the sleeve is >10mm.

**Tough** High flexibility: min. bending radius of 4mm, 10 mio. bending cycles (@ radius 10mm)

# Flat fibers

## Thru-beam type (one pair set)



Type	Shape of fiber head (mm)	Model no.	Bending radius	Fiber cable length	Sensing range (mm) (Note 1)			Beam axis dia. (mm)	Protection	Ambient temperature		
					FX-500 series	U-LG LONG FAST H-SP	FX-101 FX-102					
Flat	Top sensing W3 × H8 × D12	<b>Tough</b> FT-Z30H	R2	2m	STD 3,500 HYPR (Note 2) 3,600	3,600 (Note 2) 3,600 (Note 2) 2,400 810	1,400 3,200	2×3	IP40 (IEC)	-40 to +60°C		
	Top sensing W3 × H8 × D12	FT-Z30HW	R1		STD 3,500 HYPR (Note 2) 3,600	3,600 (Note 2) 3,600 (Note 2) 2,400 740	1,200 3,200					
	Side sensing W3 × H12 × D8	<b>Tough</b> FT-Z30E	R2		STD 3,400 HYPR (Note 2) 9,600	3,600 (Note 2) 3,600 (Note 2) 1,200 630	1,400 2,600					
	Side sensing W3 × H12 × D8	FT-Z30EW	R1		STD 2,100 HYPR (Note 2) 3,600	3,600 (Note 2) 3,600 (Note 2) 1,200 410	710 2,300					
	Front sensing W8.5 × H12 × D3	<b>Tough</b> FT-Z30	R2		STD 1,500 HYPR (Note 2) 3,600	3,300 3,200 1,000 280	540 1,800					
	Front sensing W8.5 × H12 × D3	FT-Z30W	R1		STD 530 HYPR (Note 2) 1,600	1,100 900 330 100	230 670					
	Front sensing W10 × H7 × D2	FT-Z20W			1m	STD 260 HYPR 1,100	670 570 180 55				100 320	IP67 (IEC)
	Top sensing W2 × H10 × D10	FT-Z20HBW			2m	STD 1,400 HYPR 3,500	3,300 2,300 890 290				330 1,000	-
	Front sensing W14 × H7 × D3.5	FT-Z40W			STD 800 HYPR 3,300	1,900 1,400 490 160	260 720				IP67 (IEC)	
	Top sensing B3.5 × H14 × T11	FT-Z40HBW										

**Notes:**

- 1) The sensing range of the free-cut type fiber may be reduced depending upon how the fiber is cut.
- 2) The length of the fiber cable affects the sensing range.

## Reflective type



Type	Shape of fiber head (mm)	Model no.	Bending radius	Fiber cable length	Sensing range (mm) (Note 1, 2)			Protection	Ambient temperature
					FX-500 series	U-LG LONG FAST H-SP	FX-101 Fx-102		
Flat	Front sensing W10 × H7 × D2	FD-Z20W	R1	1m	STD 2 to 65 HYPR 1 to 230	1 to 110 1 to 85 3 to 35 5 to 13	2 to 20 1 to 70	-	-40 to +60°C
	Top sensing W2 × H10 × D10	FD-Z20HBW			STD 2 to 85 HYPR 1 to 340	1 to 210 1 to 180 2 to 55 3 to 15	2 to 30 1 to 90	IP67 (IEC)	
	Front sensing W14 × H7 × D3.5	FD-Z40W			STD 110 HYPR 430	230 180 1.5 to 65 3 to 25	1 to 55 160	-	
	Top sensing W3.5 × H14 × D11	FD-Z40HBW			STD 260 HYPR 760	540 470 1 to 160 2 to 50	1 to 90 0.5 to 240	IP67 (IEC)	

**Notes:**

- 1) The sensing range of the free-cut type fiber may be reduced depending upon how the fiber is cut.
- 2) The sensing range is specified for white, matt paper.

**Tough** High flexibility: min. bending radius of 4mm, 10 mio. bending cycles (@ radius 10mm)

Photoelectric Sensors

Fiber-optic Sensors

Standard Fibers

Fiber Sensors Communication Units

Mark Sensors

Laser Sensors

Safety Sensors

Pressure & Flow Sensors

Inductive Proximity Sensors

Measurement Sensors

Ionizers / Electrostatic Sensors

Accessories

Flat fibers

## Wide beam fibers

### Reflective type

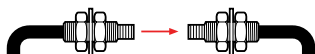

Type	Shape of fiber head (mm)	Model no.	Bending radius	Fiber cable length	Sensing range (mm) (Note 1)			Beam axis dia. (mm)	Protection	Ambient temperature
					FX-500 series	U-LG LONG FAST H-SP	FX-101 FX-102			
Wide beam	Sensing width 32mm W5 x H69 x D20	<b>Tough</b> FT-A32	R2	2m	STD (Note 2) 3,600 HYPR (Note 2) 3,600	3,600 (Note 2) 3,600 (Note 2) 2,100	3,600 (Note 2) 3,600 (Note 2)	3.2 x 32	IP40 (IEC)	-40 to +60°C
	Sensing width 32mm W5 x H69 x D20	FT-A32W	R1		STD (Note 2) 3,600 HYPR (Note 2) 3,600	3,600 (Note 2) 3,600 (Note 2) 3,000				-40 to +55°C
	Sensing width 11mm W4.2 x H31 x D13.5	<b>Tough</b> FT-A11	R2		STD (Note 2) 3,600 HYPR (Note 2) 3,600	3,600 (Note 2) 3,600 (Note 2) 1,100	1,900 (Note 2) 3,600 (Note 2)	2.2 x 11	-40 to +70°C	
	Sensing width 11mm W4.2 x H31 x D13.5	FT-A11W	R1		STD (Note 2) 3,600 HYPR (Note 2) 3,600	3,600 (Note 2) 3,600 (Note 2) 1,300	1,700 3,400		-40 to +55°C	
Array	Sensing width 5.5mm W5 x H15 x D15	<b>Tough</b> FT-AL05	R2	STD 860 HYPR 2,300	1,550 1,500 170	250 660	0.25 x 5.5		-55 to +80°C	

#### Notes:

- 1) The sensing range of the free-cut type fiber may be reduced depending upon how the fiber is cut.
- 2) The length of the fiber cable affects the sensing range.

Wide beam fibers

### Reflective type



Type	Shape of fiber head (mm)	Model no.	Bending radius	Fiber cable length	Sensing range (mm) (Note 1, 2)			Protection	Ambient temperature
					FX-500 series	U-LG LONG FAST H-SP	FX-101 FX-102		
Wide beam	W7 x H15 x D30	<b>Tough</b> FD-A16	R4	2m	STD 200 HYPR 140 cannot use	200 200 140 75	120 240	IP40 (IEC)	-40 to +60°C
Array	W5 x H20 x D20	<b>Tough</b> FD-AL11	R2		STD 320 HYPR 180 670	530 510 180 50	100 285		-55 to +80°C

#### Notes:

- 1) The sensing range of the free-cut type fiber may be reduced depending upon how the fiber is cut.
- 2) The sensing range is specified for white, matt paper.

**Tough** High flexibility: min. bending radius of 4mm, 10 mio. bending cycles (@ radius 10mm)



# Convergent reflective fibers for glass detection

## Reflective type



Type	Shape of fiber head (mm)	Model no.	Bending radius	Fiber cable length	Sensing range (mm) (Note 1, 2)			Protection	Ambient temperature
					FX-500 series	U-LG LONG FAST H-SP	FX-101 FX-102		
Glas substrate detection	Side sensing  W25 x H7.3 x D30	FD-L32H	R4	4m	STD 0 to 56 HYPR 0 to 110	0 to 87 0 to 74 1 to 38 Cannot use	16 to 30 0 to 50	IP40 (IEC)	-40 to +60°C
	Long sensing range  W20 x H29 x D3.8	<b>Tough</b> FD-L30A	R2	3m	STD 0 to 43 HYPR 0 to 43	0 to 43 0 to 43 0 to 42 0 to 29	0 to 40 0 to 50		0 to +70°C
	Long sensing range  W23.5 x H29 x D4.5	<b>Tough</b> FD-L31A	R4		STD 4 to 33 HYPR 3 to 35	4 to 33 4 to 33 4 to 32 5 to 25	5 to 30 4 to 33		
	Long sensing range  W17 x H29 x D3.8	<b>Tough</b> FD-L22A	R2	2m	STD 0 to 24 HYPR 0 to 31	0 to 28 0 to 27 0 to 24 0 to 18	0 to 19 0 to 25		-20 to +70°C
	Short sensing range  W18 x H29 x D3.8	<b>Tough</b> FD-L23		3m	STD 0 to 29 HYPR 0 to 30	0 to 30 0 to 30 0 to 28 1.5 to 24	0 to 28 0 to 30		
	Short sensing range  W12 x H19 x D3	<b>Tough</b> FD-L11	R4	2m	STD 0 to 9.5 HYPR 0 to 11.5	0 to 10.5 0 to 10 0 to 9 0 to 8	0 to 8 0 to 9		-40 to +60°C
	Short sensing range  W12 x H19 x D3	<b>Tough</b> FD-L10			STD 0 to 5 HYPR 0 to 6	0 to 5.5 0 to 5.5 0 to 4.5 0 to 4	0 to 4.5 0 to 5.5		
	Short sensing range  W24 x H21 x D4	<b>Tough</b> FD-L21	R2	STD 1.5 to 16 HYPR 1 to 19	1 to 18 1 to 18 2 to 15 3 to 12	3 to 15 1.5 to 16			
	Short sensing range  W24 x H21 x D4	FD-L21W	R1	STD 3 to 14 HYPR 1.5 to 15	2 to 15 2 to 15 4 to 14 6.5 to 10	7 to 12 3 to 14			
	Short sensing range  W6 x H18 x D14	<b>Tough</b> FD-L20H	R2	STD 23 HYPR 45	35 32 2 to 15 5 to 9	5 to 15 1 to 30	-40 to +70°C		
Ultra-small  W7.2 x H7.5 x D2	FD-L12W	R1	1m	STD 8 HYPR 14	12.5 12 0.5 to 7 0.5 to 4	1 to 4.5 0.5 to 7	IP30 (IEC)	-40 to +60°C	

### Notes:

- 1) The sensing range specified for transparent glass 100x100x0.7mm (FD-L32H: edge, FD-L21 and FD-L21W: t2mm). (FD-L20H: white non-glossy paper, FD-L10: silicon wafers 100x100x2mm).
- 2) The sensing range of the free-cut type fiber may be reduced depending upon how the fiber is cut.

## Retroreflective type



Type	Shape of fiber head (mm)	Model no.	Bending radius	Fiber cable length	Sensing range (mm) (Note 1, 2)			Protection	Ambient temperature		
					FX-500 series	U-LG LONG FAST H-SP	FX-101 FX-102				
With polarizing filter	W5.2 x H9.5 x D16  W30 x H30 x D0.5	FR-Z50HW	R1	2m	STD 100 to 990 HYPR 100 to 1,900	100 to 1,400 100 to 1,200 100 to 780 100 to 490	100 to 550 100 to 830	IP40 (IEC)	-25 to +55°C		
Side sensing	W7.5 x H2.2 x D11.2  W4 x H2 x D21.5	<b>Tough</b> FR-KZ22E	R2		STD 15 to 310 HYPR 15 to 570	15 to 460 15 to 410 15 to 220 15 to 100	15 to 200 15 to 360			IP30 (IEC)	-40 to +60°C
Narrow view	Top sensing W5.2 x H9.5 x D21  W10.6 x H28 x D10.1	<b>Tough</b> FR-KZ50H			STD 20 to 300 HYPR 20 to 1,000	20 to 800 20 to 400 20 to 200 20 to 200	20 to 200 20 to 350				
Narrow view	Side sensing W9.5 x H2.5 x D5.2  W28 x H10.6 x D10.1	<b>Tough</b> FR-KZ50E									

### Notes:

- 1) The sensing range of the free-cut type fiber may be reduced depending upon how the fiber is cut.
- 2) The sensing range is specified for the reflector.

## Chemical-resistant fibers

### ■ Thru-beam type (one pair set)



Type	Shape of fiber head (mm)	Model no.	Bending radius	Fiber cable length	Sensing range (mm) (Note 1)			Beam axis dia. (mm)	Protection	Ambient temperature
					FX-500 series	U-LG LONG FAST H-SP	FX-101 FX-102			
Chemical-resistant	 SEMI W7 x H15 x D13	FT-Z802Y	R25	 2m	STD 3,100 HYPR (Note 2) 3,600	3,600 (Note 2) 3,600 (Note 2) 1,900 470	520 3,100	ø3.7	IP67 (IEC)	0 to +60°C
	 Heat-resistant 115°C ø5.5 (25)	FT-HL80Y	R30	 2m (Note 3)	STD (Note 2) 3,600 HYPR (Note 2) 3,600	3,600 (Note 2) 3,600 (Note 2) 2,300 740	990 2,340	ø3.7	IP67g (IEC)	-40 to +115°C
	 ø5.5 (25)	FT-L80Y			STD (Note 2) 3,600 HYPR (Note 2) 3,600	3,600 (Note 2) 3,600 (Note 2) 2,800 920	1,100 2,600			
	Side sensing  ø5.5 (25)	FT-V80Y			STD 1,300 HYPR (Note 2) 3,600	2,800 2,200 800 240	340 800			

**Notes:**

- 1) The sensing range of the free-cut type fiber may be reduced depending upon how the fiber is cut.
- 2) The length of the fiber cable affects the sensing range.
- 3) The allowable cutting range is 500mm from the end inserted at the amplifier.

Chemical resistant fibers

# Heat-resistant fibers

## Thru-beam type (one pair set)



Type	Temperature	Shape of fiber head (mm)	Model no.	Bending radius	Fiber cable length	Sensing range (mm) (Note 1)			Beam axis dia. (mm)	Ambient temperature			
						FX-500 series	U-LG LONG FAST H-SP	FX-101 FX-102					
Heat-resistant fiber	350°C	Lens mountable: FX-LE1/LE2/SV1 	FT-H35-M2	R25	2m	STD 430 HYPR 1,200	880 670 250 80	170 490	ø1.2	-60 to +350°C			
		Sleeve 60mm 	FT-H35-M2S6	Standard fibers R25 Sleeve R10									
	200°C	Lens mountable: FX-LE1/LE2/SV1 	FT-H20W-M1	R10	1m	STD 470 HYPR (Note 2) 1,600	1,000 840 300 90	100 300	ø0.8	-60 to +200°C			
		Lens mountable: FX-LE1/LE2/SV1 	FT-H20-M1	R25							STD 540 HYPR (Note 2) 1,600		
	130°C	Lens mountable: FX-LE2 	FT-H13-FM2	R25	2m	STD 700 HYPR 3,300	1,900 1,300 410 140	250 700	ø1.5	-60 to +130°C			
	Heat-resistant (joint)	200°C	Lens mountable: FX-LE1/LE2/SV1 	FT-H20-J20-S (Note 5)	Heat resistant R18 (Note 4)	200mm (Note 3)	STD 470 HYPR 1,600	1,000 790 300 90	135 420	ø1.2	-60 to +200°C		
Lens mountable: FX-LE1/LE2/SV1 			FT-H20-J30-S (Note 5)	300mm (Note 3)									
Lens mountable: FX-LE1/LE2/SV1 			FT-H20-J50-S (Note 5)	500mm (Note 3)									
Side sensing 			FT-H20-VJ50-S (Note 5)	800mm (Note 3)		STD 600 HYPR 2,100						1,300 980 390 120	150 500
			FT-H20-VJ80-S (Note 5)										

**Notes:**

- 1) The sensing range of the free-cut type fiber may be reduced depending upon how the fiber is cut.
- 2) The length of the fiber cable affects the sensing range.
- 3) The fiber length of the heat-resistant side cannot be cut.
- 4) Bending radius R=25mm or more.
- 5) Heat-resistant side and ordinary temperature fiber are sold together as a set.

Photoelectric Sensors

Fiber-optic Sensors

Standard Fibers

Fiber Sensors  
Communication Units

Mark Sensors

Laser Sensors

Safety Sensors

Pressure & Flow Sensors

Inductive Proximity Sensors

Measurement Sensors

Ionizers/  
Electrostatic Sensors

Accessories

Heat resistant fibers

# Standard Fibers

## Reflective type



Type	Temperature	Shape of fiber head (mm)	Model no.	Bending radius	Fiber cable length	Sensing range (mm) (Note 1, 2)			Ambient temperature	
						FX-500 series	U-LG LONG FAST H-SP	FX-101 FX-102		
Heat-resistant fiber	350°C	Coaxial M6 	FD-H35-M2	R25	2m	STD 260 HYPR 720	540 460 150 45	75 280	-60 to +350°C	
		Sleeve 60mm 	FD-H35-M2S6	Standard fibers R25 Sleeve R10						
		Sleeve 90mm 	FD-H35-20S							
	200°C	Coaxial M6 	FD-H20-M1	R25	1m	STD 330 HYPR 840	550 500 200 55 840	120 300	-60 to +200°C	
		Coaxial M4 	FD-H20-21							
	130°C	M6 	FD-H13-FM2		2m (scissors icon)	STD 350 HYPR 880	640 600 200 65	100 280	-60 to +130°C	
	Glass substrate detection convergent reflective	300°C		FD-H30-L32	R25	2m	STD 17 HYPR 40	30 25 12 1.5 to 6	2 to 9 0 to 17	-60 to +300°C
		250°C		FD-H25-L43	3m	STD 1.5 to 26 HYPR 1 to 31	1 to 30 1 to 28 1.5 to 24 2 to 18	4 to 16 4 to 23	-20 to +250°C Standard fibers -20 to +70°C	
				FD-H25-L45						STD 5 to 42 HYPR 4 to 43.5
		180°C		FD-H18-L31		2m (scissors icon)	STD 16 HYPR 60	32 24 13 2 to 6.5	0 to 10 0 to 25	-60 to +180°C

### Notes:

- 1) The sensing range is specified for white, matt paper (50x50mm, glass substrate: FD-H30-L32, FD-H18-L31, clear glass 100x100x0.7mm: FD-H25-L43 and FD-H25-L45).
- 2) The length of the fiber cable affects the sensing range.

# Vacuum-resistant fibers

## Thru-beam type (one pair set)



Type	Shape of fiber head (mm)	Model no.	Bending radius	Fiber cable length	Sensing range (mm)			Beam axis dia. (mm)	Ambient temperature
					FX-500 series	U-LG LONG FAST H-SP	FX-101 FX-102		
Vacuum-resistant Thru-beam type	300°C Lens mountable: FV-LE1/SV2 	FT-H30-M1V-S (Note)	R18	1m	STD 27 HYPR 1,000	590 470 160 55	110 280	ø1.2	-30 to +300°C

Note: Sold as a set comprising vacuum type fiber and photo-terminal (FV-BR1).

## Reflective type



Type	Shape of fiber head (mm)	Model no.	Bending radius	Fiber cable length	Sensing range (mm) (Note 2)			Ambient temperature
					FX-500 series	U-LG LONG FAST H-SP	FX-101 FX-102	
Vacuum-resistant Convergent reflective	300°C 	FD-H30-KZ1V-S (Note 1)	R18	1m	STD 20 to 200 HYPR 5 to 500	10 to 340 15 to 270 20 to 120 20 to 45	25 to 80 10 to 220	-30 to +300°C
	300°C, Glass substrate detection 	FD-H30-L32V-S (Note 1)			3m	STD 8 HYPR 18	12 10 5,5 1.5 to 3	

**Notes:**

- Sold as a set comprising vacuum type fiber and photo-terminal (FV-BR1).
- The sensing range is specified for transparent glass 100×100×0.7mm.

Photoelectric Sensors

Fiber-optic Sensors

Standard Fibers

Fiber Sensors Communication Units

Mark Sensors

Laser Sensors

Safety Sensors

Pressure & Flow Sensors

Inductive Proximity Sensors









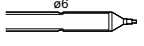

Measurement Sensors

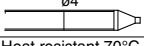
Ionizers / Electrostatic Sensors

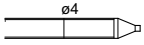
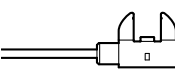
Accessories

Vacuum resistant fibers

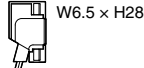
## Fibers for liquid leak/liquid detection

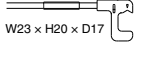
Type	Shape of fiber head (mm)	Model no.	Bending radius	Fiber cable length	Description	Protection	Ambient temperature	
Contact type	Liquid level sensing	Heat resistant 125°C Fluorine resin coating 	<b>FD-F8Y</b>	Protective tube R40 Standard fibers R15	 2m (Note 1)	ø6mm Protective tube: Fluorine resin, Length 1m (not cuttable) Liquid surface not contacted: beam received Liquid surface contacted: no beam received	IP68 (IEC)	-40 to +125°C
		Heat resistant 105°C Fluorine resin coating 	<b>FD-HF40Y</b>	Protective tube R20 Standard fibers	 2m	ø4mm Protective tube: Fluorine resin, Length 500mm (not cuttable) Liquid surface not contacted: beam received Liquid surface contacted: no beam received	IP67 (IEC)	-40 to +105°C
		Heat resistant 70°C Fluorine resin coating 	<b>FD-F41Y</b>	<b>R10</b>		ø4mm Protective tube: Fluorine resin, Length 500mm (not cuttable) Liquid surface not contacted: beam received Liquid surface contacted: no beam received		
Pipe-mountable type	Liquid leak detection	SEMI S2 W20xH30xD10 	<b>Tough</b> <b>FD-F71</b>	Protective tube R20 Standard fibers <b>R4</b>	 5m	Liquid leak detection Leak absent: beam received Leak present: no beam received	-	-20 to +60°C
		Default  W25 x H13 x D20	<b>FD-F41</b>	<b>R10</b>		Applicable pipe diameter: Outer dia.: ø6mm to ø26mm Material: transparent pipe, PFA (fluorine resin, polycarbonate, acrylic, glass) Wall thickness: 1 to 3mm Liquid absent: beam received Liquid present: no beam received		
	For wall thickness 1mm  W25 x H13 x D20	<b>FD-F4</b>	 2m		Applicable pipe diameter: Outer dia.: ø6mm to ø26mm Material: transparent pipe, PFA (fluorine resin). Wall thickness: 1mm. Liquid absent: beam received Liquid present: no beam received			
	Liquid leak detection	Mountable on pipe W6.5 x H28.3 x D17 	<b>Tough</b> <b>FD-FA93</b>	<b>R4</b>	 2m	Applicable pipe diameter: Outer dia.: ø8mm or more (When used with the tying bands: ø8mm to ø80mm) Material: transparent pipe, PFA (fluorine resin). Liquid absent: beam received Liquid present: no beam received	IP40 (IEC)	-40 to +70°C
		SEMI S2 W23 x H20 x D17 	<b>Tough</b> <b>FT-F93</b>	Protective tube R20 Standard fibers <b>R2</b>		Applicable pipe diameter: Outer dia.: ø3mm to ø10mm material: transparent pipe, PFA (fluorine resin). Wall thickness: 0.3 to 1mm Liquid absent: beam received Liquid present: no beam received		-40 to +60°C

**Note:** The allowable cutting range is 500mm from the end inserted at the amplifier.

**Tough** High flexibility: min. bending radius of 4mm, 10 mio. bending cycles (@ radius 10mm)

## Accessories

- **RF-003** (Reflector for **FR-KZ21/KZ21E**)
- **RF-13** (Reflective tape for reflective type)
- **FX-CT1** (Fiber cutter)
- **FX-CT2** (Fiber cutter)
- **FX-CT3** (Fiber cutter)
- **FX-AT2** (Attachment for fixed-length fiber, Orange)
- **FX-AT3** (Attachment for ø2.2mm fiber, Clear orange)
- **FX-AT4** (Attachment for ø1mm fiber, Black)
- **FX-AT5** (Attachment for ø1.3mm fiber, Gray)
- **FX-AT6** (Attachment for ø1mm / ø1.3mm fiber, Black/Gray)

RF-003



RF-13

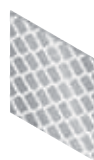

FX-CT1



FX-CT2

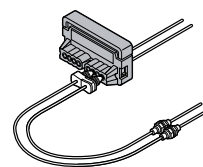

FX-CT3



FX-AT2

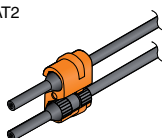

FX-AT3

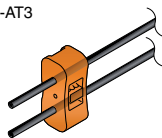

FX-AT4

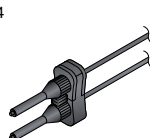



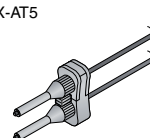

FX-AT5

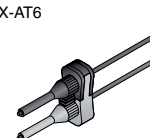

FX-AT6

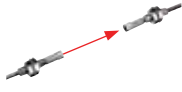
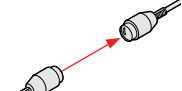

## ■ Lens (for thru-beam type fiber)

Model no.	Picture	Description	Applicable fibers
FX-LE1		Expansion lens increases the sensing range by 5 times or more, ambient temperature: -60 to +350°C (Note 1, 2)	FT-43, FT-42, FT-42W, FT-45X, FT-R40, FT-H35-M2, FT-H20W-M1, FT-H20-M1, FT-H20-J50-S, FT-H20-J30-S, FT-H20-J20-S
FX-LE2		Expansion lens increases the sensing range by 6 times or more, ambient temperature: -60 to +350°C (Note 1, 2)	
FX-SV1		Side-view lens, beam axis is bent by 90°, ambient temperature: -60 to +300°C (Note 1, 2)	
FV-LE1		Expansion lens for vacuum fiber increases the sensing range by 4 times or more, ambient temperature: -60 to +350°C (Note 1, 2)	FT-H30-M1V-S
FV-SV2		Vacuum resistant side-view lens, beam axis is bent by 90°, ambient temperature: -60 to +300°C (Note 1, 2)	

## ■ Lens (for reflective type fiber)

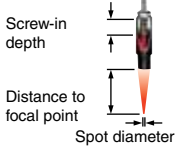
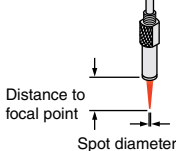
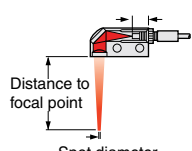
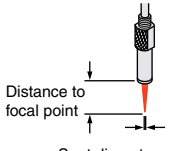
Model no.	Picture	Description	Applicable fibers
FX-MR1		Pinpoint spot lens, distance to focal point 6±1mm, spot diameter Ø 0.5mm, ambient temperature -40 to +70°C (Note 1, 2)	FD-42G, FD-42GW
FX-MR2		Zoom lens, screw-in depth (7-14mm), distance to focal point (18.5- 43mm), spot diameter Ø 0.7-2mm, ambient temperature: -40 to +60°C (Note 1, 2)	
FX-MR3		Extremely fine spot, distance to focal point: 7.5±0.5mm, spot diameter: <b>FD-EG31</b> Ø 0.15mm/ <b>FD-EG30</b> Ø 0.3mm/ <b>FD-42G, FD-42WG, FD-32G, FD-32GX</b> Ø 0.5, ambient temperature: -40 to +70°C (Note 1, 2)	<b>FD-EG31, FD-EG30, FD-42G, FD-42GW, FD-32G, FD-32GX</b>
FX-MR5		Zoom lens, screw-in depth, (8-14mm), distance to focal point (13-30mm), Spot diameter Ø 0.5-3mm, ambient temperature: -40 to +70°C (Note 1, 2)	FD-42G, FD-42GW
FX-MR6		Extremely fine spot, distance to focal point 7.5 ±0.5mm, spot diameter: <b>FD-EG31</b> Ø 0.1mm/ <b>FD-EG30</b> Ø 0.2mm/ <b>FD-42G, FD-42WG, FD-32G, FD-32GX</b> Ø 0.4mm. ambient temperature: -40 to +60°C (Note 1, 2)	<b>FD-EG31, FD-EG30, FD-42G, FD-42GW, FD-32G, FD-32GX</b>

### Notes:

- 1) Consider the ambient temperature of the fibers to be used in combination.
- 2) Please test the functionality after mounting the lenses.

- Photoelectric Sensors
- Fiber-optic Sensors
- Standard Fibers
- Fiber Sensors Communication Units**
- Mark Sensors
- Laser Sensors
- Safety Sensors
- Pressure & Flow Sensors
- Inductive Proximity Sensors
- Measurement Sensors
- Ionizers/ Electrostatic Sensors
- Accessories
- Index



# FX-CH2

**External input unit for fiberoptic sensors**

## Functions

**■ Combining up to 16 sensors**  
Up to 16 sensors can be set/switched simultaneously by an external signal. The sensors can be operated from a PLC, a touch panel, a push button, or some other external signal generating device.

**■ Simultaneous teaching**

- Full-auto teaching
- 2-level teaching

Even the enable/disable command for the key lock setting, a function designed to prevent operational mistakes, can be effected simultaneously from an external signal.

**■ Batch loading and saving of bank settings**  
The bank settings for 3 previously set channels can be loaded and saved all together using an external signal.

## Technical specifications

Type	NPN input	PNP input
Model no.	FX-CH2	FX-CH2-P
Applicable sensor	FX-301(P), FX-305(P)	
Power supply voltage	12 to 24VDC ±10%	
Input	Low: 0 to +2VDC High: +5V to +VDC, or open	Low: 0 to +0.6VDC, or open High: 4V to +VDC
Power indicator	Green LED	
Transmission operation indicator	Green LED (lights up when loaded, and 2-level/limit teaching blinks lights up when saved, and full-auto teaching)	
Ambient temperature	-10 to +55°C (if 4 to 7 sensors are mounted close together: -10 to +50°C; if 8 to 16 sensors are closed together: -10 to +45°C)	
Connection method	Connector (Note)	
Dimensions (HxWxD)	10x27x68.5mm	

**Note:** Please select under accessories (page 125).

## Typical applications

**■ Setup changes (external automatic teaching/data bank switching)**

Digital fiber settings can be changed using input from a touch screen or switch so that production line setup changes can be carried out more easily.

**■ External teaching function**

Full auto-teaching is recommended for teaching when the sensing object is changed without stopping the line.

**■ Data bank switching**

Settings such as output operations (Light-ON/Dark-ON) and timer operations can be recorded in the digital fiber sensor's data bank, and switching can be carried out externally.

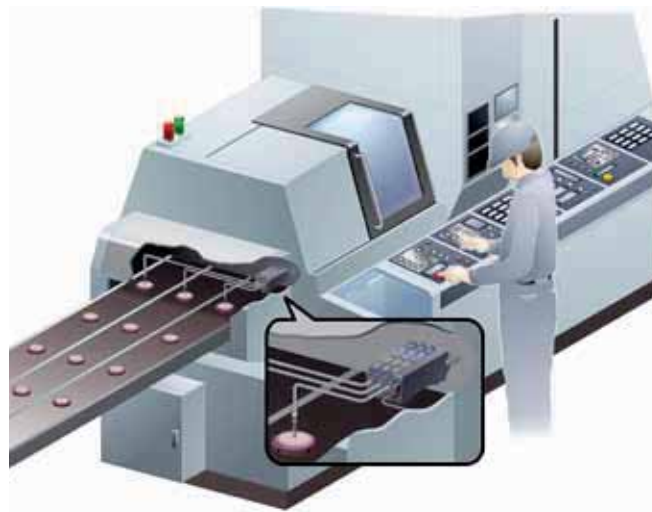



# SC-GU1-485



## Fiber sensor communication units

Photoelectric Sensors

Fiber-optic Sensors

Standard Fibers

Fiber Sensors Communication Units

Mark Sensors

Laser Sensors

Safety Sensors

Pressure & Flow Sensors

Inductive Proximity Sensors

Measurement Sensors

Ionizers / Electrostatic Sensors

Accessories

Index

SC-GU1-485

## Functions

- Function handy for startup and maintenance

Using a PLC or PC, this communication unit not only facilitates inputs (teaching, bank switching) to a digital fiber sensor [FX-301(P)], but also received-light amount and output status verifications greatly enhance workability during startup and maintenance.

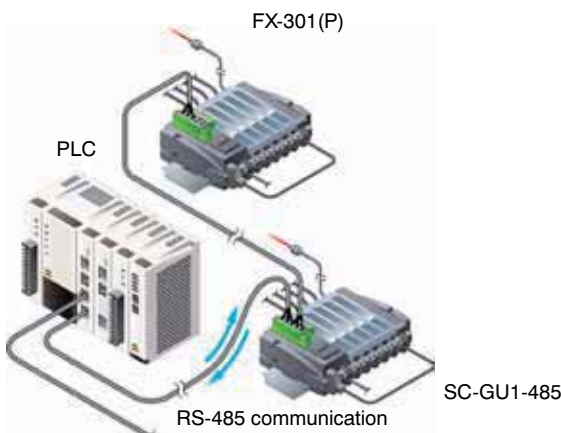

- Series connection (RS-485) of a maximum of 31 nodes is possible

A maximum of 31 nodes can be connected in series. This is ideal for flexible handling when the sensors are to be installed in scattered locations or when more sensors are added.

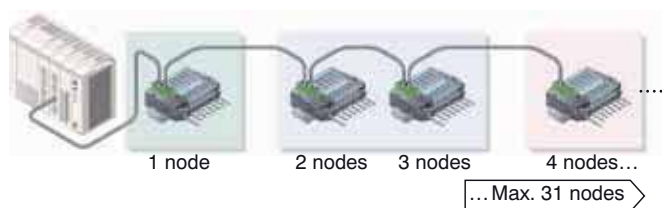

## Technical specifications

Type	Main unit for RS-485
Model no.	SC-GU1-485
Applicable sensors	FX-501(P), FX502(P), FX-301(P), 305(P), LS-403, DPS-401(P), DPS-402(P), SC-T1JA (Note)
Number of connectable units	16
Baud rate	57600bps / 38400bps / 19200bps / 9600bps selectable by DIP switch
Total extension length	100m or less (power supply cable 10m or less)
Communication method	2 wire half duplex method
Power supply voltage	24V DC $\pm$ 10%
Current consumption	45mA or less
Ambient temperature	-10 to +55°C (if 4 to 7 digital sensors are connected in cascade: -10 to +50°C, if 8 to 16 digital sensors are connected in cascade: -10 to +45°C)
Material	Enclosure: ABS, Connector cap: silicone rubber
Accessories	End unit: SC-GU1-EU 1pc. / Quick-connection cable: CN-73-C2 1 pc. / Link cable: SC-GU1-CC02 1pc.

Note: Suffix P= PNP output

- Photoelectric Sensors
- Fiber-optic Sensors
- Standard Fibers
- Fiber Sensors Communication Units**
- Mark Sensors
- Laser Sensors
- Safety Sensors
- Pressure & Flow Sensors
- Inductive Proximity Sensors
- Measurement Sensors
- Ionizers/ Electrostatic Sensors
- Accessories
- Index



# SC-GU3

**Communication unit for open network**

## Functions

### ■ Operation procedure

The **SC-GU** Communication Units make it easy to connect various sensors to your PLC or PC via an open network.

Quick connection technology simplifies exchanging single units or expanding the whole system.



### ■ Combining different units

The ability to combine different sensor types, e.g. laser sensors, pressure sensors or digital fiber-optic sensors, opens up many application areas, especially for special purpose machinery manufacture. The sensors themselves communicate with each other via an infrared interface.

### ■ Intuitive integration at the controller level

Rapid integration at the controller level enables reliable monitoring, remote maintenance or remote control via open networks. Several units can be configured with minimal wiring efforts. Data can be saved centrally, where it can be archived or used for evaluation purposes.



## Technical specifications

Type	Communication unit for CC-Link	Communication unit for DeviceNet	Communication unit for EtherCAT
Model no.	SC-GU3-01	SC-GU3-02	SC-GU3-03
Applicable sensors	FX-501, FX502, FX-301, 305, LS-403, DPS-401, DPS-402, SC-T1JA (Note)		
Number of connectable units	16 ( FX-500: 12 units)		
Baud rate	10Mbps / 5Mbps / 2.5 Mbps / 625kbps / 156kbps	500kbps / 250kbps / 125kbps	100Mbps
Total extension length	100 bis 1200m or less (differs depending on the extension length)	100m (depending on the cable) or less	100m or less
Communication method	CC-Link Ver.1.10	DeviceNet compliant	Process data, telegram (IEEE802.3u)
Power supply voltage	24VDC ±10%	11 to 25V DC	24V DC+10%/−15%
Current consumption	120mA or less	80mA or less	100mA or less
Ambient temperature	−10 to +55°C (if 4 to 7 digital sensors are connected in cascade: −10 to +50°C, if 8 to 16 digital sensors are connected in cascade: −10 to +45°C)		
Material	Enclosure: polycarbonate		

Note: only NPN



**Would you like more information?**

Please visit us: [www.panasonic-electric-works.com](http://www.panasonic-electric-works.com)

or call us:

**Tel.: +49(0)8024 648-737**

# LX-100

Introducing the 3-LED mark sensor



## Functions

### ■ Equipped with 3 LEDs: red, green and blue

To detect any marking, this sensor is equipped with red, green and blue LED light emitting elements all in one. In addition, it uses a coaxial reflective optics system and realizes high precision sensing when used with a 1/4000 resolution 12-bit A/D converter.



### ■ 2 selectable sensing modes for any application

**Mark mode:** This sensing mode automatically selects a single color from the 3 R-G-B LEDs to realize an ultra quick 45µs response time. The automatic optimal LED selection function automatically selects the LED that is most suitable for the sensing. This function is perfect for ultra quick sensing.

**Color mode:** All 3 R-G-B LEDs light up and high precision mark color discrimination occurs using the R-G-B reflective light ratio. This function enables effective detection of films with patterns around the areas of the mark.



### ■ Even beginners can quickly master MODE NAVI operation

The sensor's basic operations are represented by 6 indicator lamps (MODE NAVI). The user can check what mode the sensor is presently in with a quick glance rendering operation simple.

#### Sensing status digitally controllable

The sensing status, displayed numerically, can be verified at a glance. Also, the sensor settings for each type of packing film can be digitally indicated.

#### Direct codes enable settings verification at a glance

The settings for the LX-100 series sensors are displayed using a 4-digit direct code. Direct codes enable easy settings verification and maintenance by phone.

#### Super simple teaching

Teaching (setting the threshold value) is simple, even in "Mark Mode" or "Color Mode". In addition, because teaching via an operation panel or other external input device is also possible, models can be easily interchanged.

#### Compact design for significant space savings

Cable and plug-in connector types are available depending on the equipment used. These sensors can be easily integrated into already existing systems.

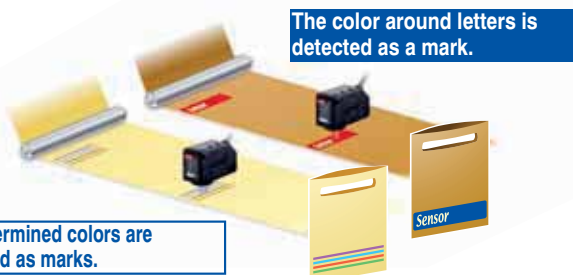

# Typical applications

## Tube positioning

Detects printed marks to align tubes.

## Mark detection

Mark detection of packaging film.

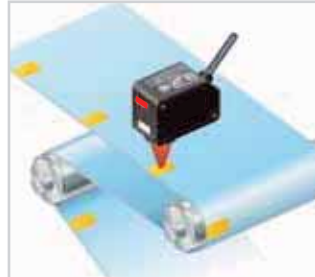

# Technical specifications

Type		Cable	M12 plug-in connector type
Model no.	NPN output	LX-101	LX-101-Z (Note 1)
	PNP output	LX-101-P	LX-101-P-Z
Sensing range		10±3mm	
Power supply voltage		12 to 24VDC ±10%	
Output		2 x NPN or 2 x PNP open-collector transistor; 50mA or less	1 x NPN or 1 x PNP open-collector transistor; 100mA or less
Output operation		Mark mode: Light-ON/Dark-ON (auto-setting on teaching) Color mode: Consistent-ON/Inconsistent-ON (setting on teaching)	
Response time		Mark mode: 45µs or less; color mode: 150µs or less	
Sensitivity setting		Mark mode: 2-level teaching/Limit teaching; Color mode: 1-level teaching	
Protection		IP67 (IEC)	
Ambient temperature		-10 to +55°C	
Emitting element		Combined Red/Green/Blue LED (Peak emission wave length: 640nm/525nm/470nm)	
Connection method		Cable 2m	M12 connector (Note 2)
Dimensions (HxWxD)		35x24x57mm	35x24x71.5mm
Accessories		M4 screws with washers, 2 pcs.	

### Notes:

- 1) Suffix -Z=M12 connector type
- 2) Cable is not included in delivery. Please select under accessories (page 125).

Photoelectric Sensors

Fiber-optic Sensors

Standard Fibers

Fiber Sensors Communication Units

Mark Sensors

Laser Sensors

Safety Sensors

Pressure & Flow Sensors

Inductive Proximity Sensors

Measurement Sensors

Ionizers/ Electrostatic Sensors

Accessories

Index

LX-100

- Photoelectric Sensors
- Fiber-optic Sensors
- Standard Fibers
- Fiber Sensors Communication Units
- Mark Sensors
- Laser Sensors**
- Safety Sensors
- Pressure & Flow Sensors
- Inductive Proximity Sensors
- Measurement Sensors
- Ionizers/ Electrostatic Sensors
- Accessories
- Index
- EX-L200



# EX-L200

**Miniature laser sensor with a built-in amplifier!**

## Features

- Minute object sensing type EX-L211 (thru-beam)

The beam of the **EX-L200** series is purposely widened to have a lower beam density and little beam spread so that when detecting minute objects, even a slight change in the light received intensity will not be missed.

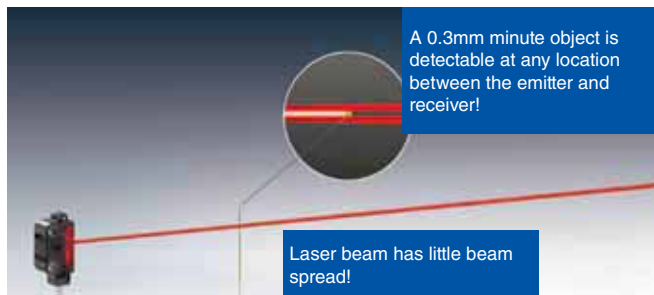

- Minute detection (reflective)

With a repeatability of 0.02mm the sensor is perfectly suited for positioning tasks.

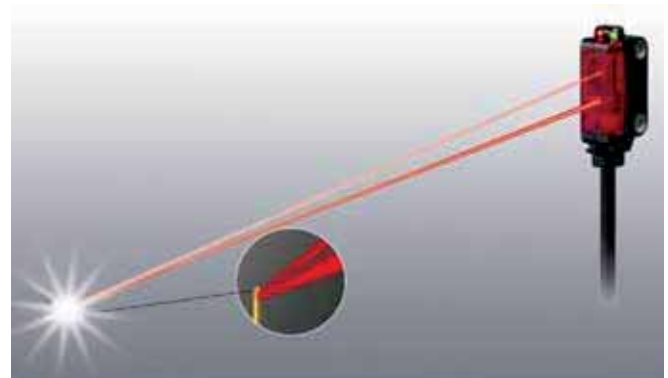

- Environmental resistance

Thanks to the IP67 casing, the sensor is suitable for installation in humid and dusty environments.



- Easy alignment

Beam alignment is carried out by looking at the red spot reflected on the beam alignment screen to match with the actual object. The optimum position can be understood at a glance by looking at the beam alignment screen and stability indicator (green).

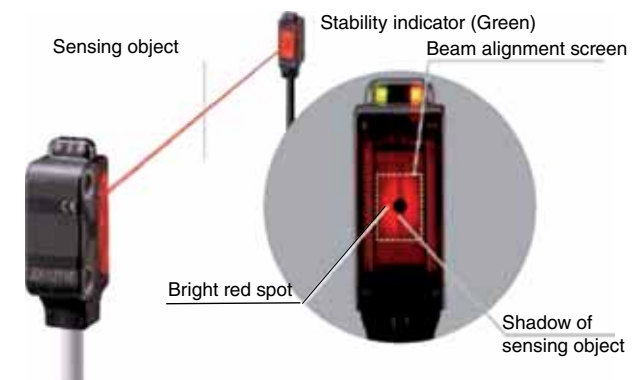

**Easy adjustment by reflecting the shadow of the detection object.**

# Typical applications

Detecting ICs that are out of position in multiple palettes

Detecting the tip of a very thin pipe

Detecting objects from an opening

Detecting very small objects

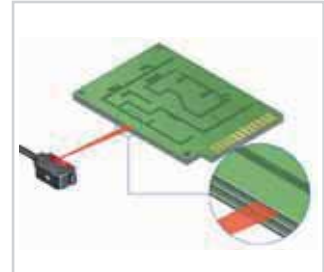
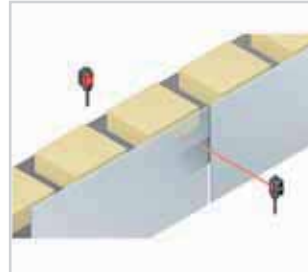

# Technical specifications

Type		Thru-beam type	Thru-beam type	Reflective type	Reflective type		
					Spot reflective	Convergent reflective spot	Convergent reflective line spot
Model no.	NPN output	EX-L211	EX-L212	EX-L291	EX-L221	EX-L261	EX-L262
	PNP output	EX-L211P	EX-L212P	EX-L291P	EX-L221P	EX-L261P	EX-L262P
Sensing range		1m	3m	4m	45 to 300mm	20 to 50mm	20 to 70mm
Emission spot size		6x4mm at 1m	8x5.5mm at 1m	6x4mm at 1m	Ø 1mm (at 300mm)	Ø 1mm at 50mm (convergent point: 22mm)	1x5mm at 50mm (convergent point: 22mm)
Object to be sensed		Ø 2mm (opaque)	Ø 3mm (opaque)	Ø 25mm (opaque)	Opaque, transparent		
Power supply voltage		12 to 24VDC ±10%					
Output		PNP / NPN open-collector transistor, 50mA or less					
Response time		0.5ms or less					
Emitting element		Red semiconductor laser (class 1)					
Protection		IP67 (IEC)					
Ambient temperature		-10 to +55°C					
Material		Enclosure: PBT, front cover: acrylic; lenses: glass					
Connection method		Cable, 2m					
Dimensions (HxWxD)		25.9x 8.2x12mm		29.9x8.2x13mm		29.9x8.2x13.5mm	
Accessories		Mounting plates <b>MS-EXL2-2</b> 2 pcs.		Reflector RF330, mounting plate <b>MS-EX-L2-3</b> 1 pc.		Mounting plate <b>MS-EX-L2-3</b> 1 pc.	

Photoelectric Sensors

Fiber-optic Sensors

Standard Fibers

Fiber Sensors Communication Units

Mark Sensors

Laser Sensors

Safety Sensors

Pressure & Flow Sensors

Inductive Proximity Sensors

Measurement Sensors

Ionizers / Electrostatic Sensors

Accessories

Index

EX-L200

# LS



User-friendly, advanced high precision laser sensing!

## Features

- 4 types of identically sized sensor heads available

They are approximately the same size as general purpose photoelectric sensors, and the mounting method is identical.

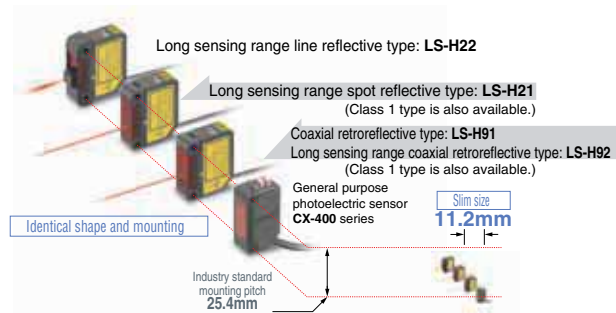

- Coaxial reflective type with a long sensing range of 30m

The introduction of the LS-H92 long sensing range coaxial reflective type sensor means that even longer sensing ranges are now possible.

- Spot size adjustment

The long sensing range spot reflective type and long sensing range line reflective type have a built-in spot-size adjuster that enables spot size adjustment according to the object for optimal setting.



- Accurately senses the minutest variations

When sensing at close range or when the target objects are transparent or minute, adjust the sensor receiving sensitivity to one of 3 levels for the optimal setting. In addition, changing the receiving sensitivity will not affect the response time.

- Easy setting, dual display

Equipped with 2 large 4-digit digital displays. While checking the current light-receiving amount (red display), the optimal threshold value (green display) can be set easily.

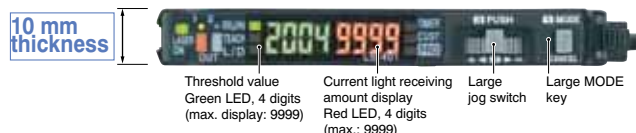

- Wiring and space savings

The quick-connection cables enable reductions in wiring (connector type). The connections and man hours for the intermediate terminal block setup can be reduced and valuable space saved. Also LS series amplifiers can be connected side-by-side with FX-300/FX-500 series fiber sensors.





# Typical applications

## Interference prevention

The automatic interference prevention function protects against interference among up to 4 sensors.

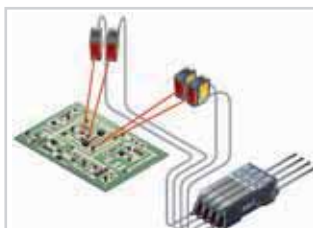

## IC pin check from remote position

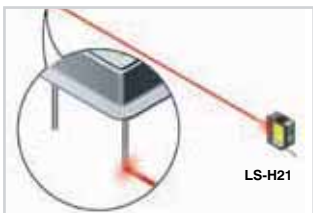

## Emission halt function

Using the emission halt function, the laser beam can be stopped via external input, e.g. when a spot appears within the visual range of an image processor.



## Checking protrusion of glass substrate



## External teaching function

Teaching can be conveniently performed externally for laser sensors installed inside a device.



# Technical specifications

## Sensor heads

Type	Coaxial retroreflective		Diffuse reflective	
	Standard	Long sensing range type	Long sensing range spot-reflective	Long sensing range line reflective
Model no. (Note 1)	LS-H91(F) (-A) (Note 2)	LS-H92(F)	LS-H21(F) (-A) (Note 2)	LS-H22(F) (Note 3)
Sensing range	0.1 to 7m (U-LG) 0.1 to 5m (STD) 0.1 to 3m (FAST/H-SP)	0.2 to 30m (U-LG) 0.2 to 20m (STD) 0.2 to 10m (FAST/H-SP)	30 to 1,000mm (U-LG) 30 to 500mm (STD) 30 to 300mm (FAST/H-SP)	30 to 1,000mm (U-LG) 30 to 500mm (STD) 30 to 300mm (FAST/H-SP)
Ambient temperature	-10 to +55°C			
Emitting element	Red semiconductor laser, LS-H□: Laser class 2, LS-H□-A: Laser class 1,			
Dimensions (W×H×D)	11.2×31×25mm			
Accessories	Reflector RF-330 1 pc., warning label (English) 1 pc.	Reflector RF-230 1pc. warning label (English) 1 pc.	Warning label (English) 1 pc.	LS-MR1 Lens attachment for line reflective 1 pc., warning label (English) 1 pc.

### Notes:

- 1) LS-Hx conforms to IEC/JIS/GB standards.  
LS-HxF conforms to FDA/IEC/JIS standards.
- 2) LS-H91(F)-A, LS-H21(F)-A: Class 1 type.
- 3) LS-H22(F) =LS-H21(F) with the LS-MR1 lens attachment for line reflective type.

## Amplifiers

Type		Connector type (Note)	Cable type
Model no.	NPN output	LS-401	LS-401-C2
	PNP output	LS-401P	LS-401P-C2
Power supply voltage		12 to 24V DC ±10%	
Output		PNP / NPN open-collector transistor, 100mA or less	
Output operation		Selectable either Light-ON or Dark-ON, with jog switch	
Response time		80µs or less (H-SP), 150µs or less (FAST), 500µs or less (STD), 4ms or less (U-LG), selectable with jog switch	
Digital display		4 digit (green) and 4 digit (red) LED display	
Automatic interference prevention function		Incorporated (up to four sets of sensor heads can be mounted close together; however disabled when in H-SP mode)	
Ambient temperature		-10 to +55°C (If 4 to 7 sensors are mounted close together: -10 to +50°C) (If 8 to 16 sensors are mounted close together: -10 to +45°C)	
Connection method		Connector (Note)	Cable, 2m
Dimensions (W×H×D)		10×30×75mm	

### Note:

The cable for amplifier connection is not supplied as an accessory with the connector type amplifier. Please select under accessories (page 125).

Photoelectric Sensors

Fiber-optic Sensors

Standard Fibers

Fiber Sensors Communication Units

Mark Sensors

Laser Sensors

Safety Sensors

Pressure & Flow Sensors

Inductive Proximity Sensors

Measurement Sensors

Ionizers / Electrostatic Sensors

Accessories

Index

LS

- Photoelectric Sensors
- Fiber-optic Sensors
- Standard Fibers
- Fiber Sensors Communication Units
- Mark Sensors
- Laser Sensors
- Safety Sensors**
- Pressure & Flow Sensors
- Inductive Proximity Sensors
- Measurement Sensors
- Ionizers / Electrostatic Sensors
- Accessories
- Index
- ST4



# ST4

Type 4 · PLe · SIL3

**Cascadable thru-beam sensors**

## Features

- Series connection of six sets of sensor heads to one controller

The concept of connecting six sets of sensor heads to one controller in series offers you maximum flexibility to solve your safety application.

- Beam axis alignment and operation confirmation

The beam interruption indicator is incorporated in both the emitter and receiver. This indicator can be used not only to confirm operation but also to align the beam axis.

- Compact sensor head saves space

The size of this type 4 long sensing range type is similar to general purpose photoelectric sensors.

- IP67 (IEC)

The sensor heads can be used safely even in rough production environments.

- Interference prevention

The emission amount adjuster can be used to prevent interference to the surrounding sensors.

- Supports both PNP and NPN polarities

A single unit supports both PNP and NPN polarities, easing stock management.

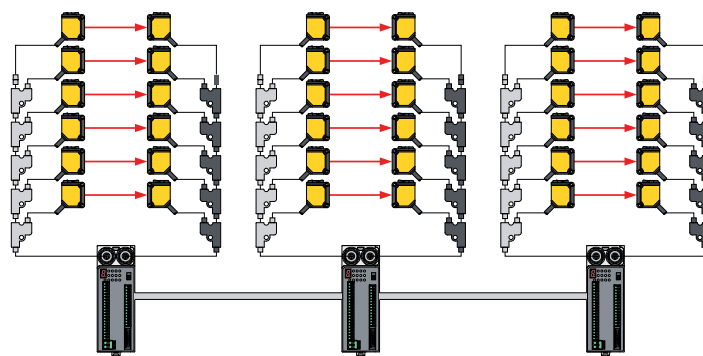

Connection of up to 3x6 units



Emission amount adjustment function

# Typical applications

## Protection for long sensing ranges

Guard areas up to 15m in length, for example where protective fences are difficult to install.

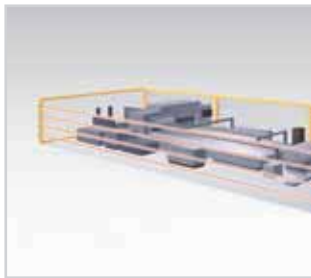

## Protection for small openings

For small openings where light curtains do not fit, ST4 sensor heads ensure safety.



## Protection against non-authorized entry

Sensor heads can be mounted flexibly and muting control implemented easily.



# Technical specifications

## ■ Sensor heads

Type	Cable length 0.2m		Cable length 1.0m	
	–	With sensitivity adjuster	–	With sensitivity adjuster
Model no.	ST4-A1-J02	ST4-A1-J02V	ST4-A1-J1	ST4-A1-J1V
Safety category	Type 4, PLe, SIL3			
Cascading	Up to 6 pieces to one controller			
Power supply voltage	Supplied from controller (ST4-C11 or ST4-C12EX)			
Sensing range	0.1 to 15m			
Sensing object	Ø9mm opaque			
Emitting element	Infrared LED			
Protection	IP67 (IEC)			
Ambient temperature	–10 to +55°C			
Material	Enclosure: PBT/Cover: acrylic			
Connection method	Cable with connector enclosed, 0.2m		Cable with connector enclosed, 1.0m	
Dimensions (HxWxD)	31x14x28mm			

## ■ Control device

Type	Standard	High-functional controller
Model no.	ST4-C11	ST4-C12EX
Safety category	Type 4, PLe, SIL3	
Power supply voltage	24VDC +10% / –15%	
Control outputs	OSSD1 and OSSD2 (2x PNP or 2x NPN transistor outputs with open collector, switchable, 200mA or less)	
Response time	ON -> OFF: 25ms or less, OFF -> ON: 140ms or less	
Current consumption	100mA or less (excluding sensor heads)	120mA or less (excluding sensor heads)
Protection	Enclosure: IP40 (IEC), Terminal: IP20 (IEC)	
Ambient temperature	–10 to +55°C	
Material	Enclosure: ABS	
Connection method	Connector (sensors), terminal block	
Dimensions (HxWxD)	130x46x80mm	

Note: For a system configuration, please contact your sales office or service hotline: +49(0)-8024648-737.

- Photoelectric Sensors
- Fiber-optic Sensors
- Standard Fibers
- Fiber Sensors Communication Units
- Mark Sensors
- Laser Sensors
- Safety Sensors**
- Pressure & Flow Sensors
- Inductive Proximity Sensors
- Measurement Sensors
- Ionizers / Electrostatic Sensors
- Accessories
- Index



## SF2B Vers.2

Type 2 · PLd · SIL2

Excellent basic functions at a reasonable price

### Features

- Unit length = Protective height, “ZERO” dead zone

Non-wasteful installation is possible, with no dead corners within the sensing width.

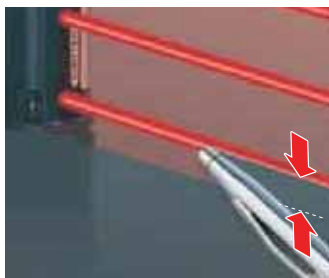

- Also suppresses mutual interference and effects of extraneous light

The tried and proven ELCA function suppresses operating errors resulting from mutual interference and the effects of extraneous light, and prevents drops in line efficiency rates from occurring.

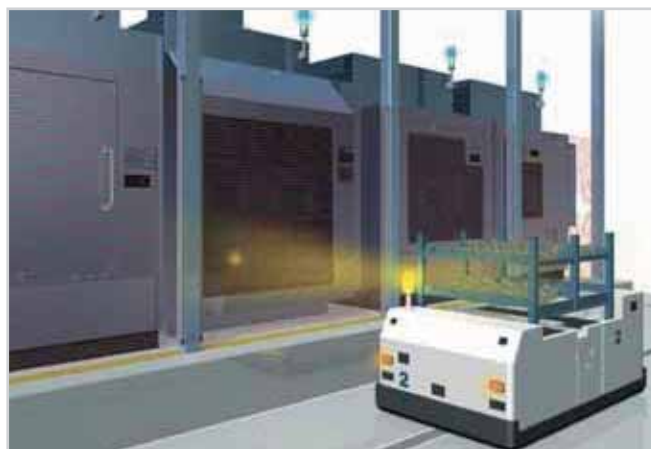

- Seamless structure using an inner enclosure

The internal unit fits into an inner enclosure, completely eliminating seams (joints) inside the product and conforming to IP67 (IEC).

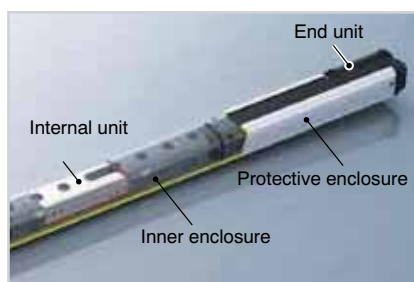

- Digital error indicator

The digital error indicator supports the resolution of electrical problems when starting up lines.

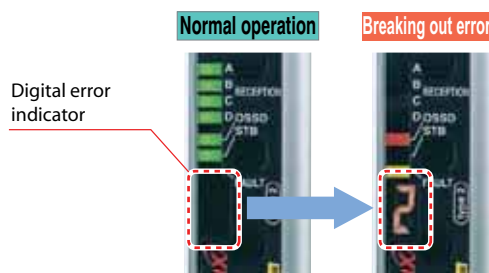

# Technical specifications

Type		Hand protection type	Arm / Foot protection type
Model no.	NPN output	SF2B-H□N (Note)	SF2B-A□N
	PNP output	SF2B-H□P	SF2B-A□P
Safety category		Type 2, PLd, SIL2	
Sensing height		168 to 1912mm	
Sensing range		0.2 to 13m	
Resolution		20mm	40mm
Minimum sensing object		Ø > 27mm (opaque)	Ø > 47mm (opaque)
Power supply voltage		24VDC ±15%	
Response time		ON -> OFF: 15ms or less / OFF -> ON: 60ms or less	
Control outputs		OSSD1 and OSSD2 (2 x PNP or 2 x NPN open collector transistor, switchable), max. 200 mA	
Emitting element		Infrared LED	
Protection		IP65 (IEC)	
Ambient temperature		-10 to +55°C	
Material		Frame: aluminum, die-cast zinc / Inner unit: polycarbonate, polyester resin / Enclosure: PBT	
Connection method		Connector	
Dimensions (HxWxD)		Hx28x24mm (H= protective height)	

Note: For a system configuration, please contact your sales office or service hotline: +49(0)-8024648-737

## Sensing height

Hand protection type	Model no.			Protective height (mm)	Installation height (mm)	No. of beam axes
	PNP type	NPN type	Sub sensors for serial connection			
	SF2B-H8-P	SF2B-H8-N	SF2B-H8SL	168	168	8
	SF2B-H12-P	SF2B-H12-N	SF2B-H12SL	232	232	12
	SF2B-H16-P	SF2B-H16-N	SF2B-H16SL	312	312	16
	SF2B-H20-P	SF2B-H20-N	SF2B-H20SL	392	392	20
	SF2B-H24-P	SF2B-H24-N	SF2B-H24SL	472	472	24
	SF2B-H28-P	SF2B-H28-N	SF2B-H28SL	552	552	28
	SF2B-H32-P	SF2B-H32-N	SF2B-H32SL	632	632	32
	SF2B-H36-P	SF2B-H36-N	SF2B-H36SL	712	712	36
	SF2B-H40-P	SF2B-H40-N	SF2B-H40SL	792	792	40
	SF2B-H48-P	SF2B-H48-N	SF2B-H48SL	952	952	48
	SF2B-H56-P	SF2B-H56-N	SF2B-H56SL	1112	1112	56
	SF2B-H64-P	SF2B-H64-N	SF2B-H64SL	1272	1272	64
	SF2B-H72-P	SF2B-H72-N	SF2B-H72SL	1432	1432	72
	SF2B-H80-P	SF2B-H80-N	SF2B-H80SL	1592	1592	80
	SF2B-H88-P	SF2B-H88-N	SF2B-H88SL	1752	1752	88
	SF2B-H96-P	SF2B-H96-N	SF2B-H96SL	1912	1912	96

Arm / Foot protection type	Model no.			Protective height (mm)	Installation height (mm)	No. of beam axes
	PNP type	NPN type	Sub sensors for serial connection			
	SF2B-A4-P	SF2B-A4-N	SF2B-A4SL	168	168	4
	SF2B-A6-P	SF2B-A6-N	SF2B-A6SL	232	232	6
	SF2B-A8-P	SF2B-A8-N	SF2B-A8SL	312	312	8
	SF2B-A10-P	SF2B-A10-N	SF2B-A10SL	392	392	10
	SF2B-A12-P	SF2B-A12-N	SF2B-A12SL	472	472	12
	SF2B-A14-P	SF2B-A14-N	SF2B-A14SL	552	552	14
	SF2B-A16-P	SF2B-A16-N	SF2B-A16SL	632	632	16
	SF2B-A18-P	SF2B-A18-N	SF2B-A18SL	712	712	18
	SF2B-A20-P	SF2B-A20-N	SF2B-A20SL	792	792	20
	SF2B-A24-P	SF2B-A24-N	SF2B-A24SL	952	952	24
	SF2B-A28-P	SF2B-A28-N	SF2B-A28SL	1112	1112	28
	SF2B-A32-P	SF2B-A32-N	SF2B-A32SL	1272	1272	32
	SF2B-A36-P	SF2B-A36-N	SF2B-A36SL	1432	1432	36
	SF2B-A40-P	SF2B-A40-N	SF2B-A40SL	1592	1592	40
	SF2B-A44-P	SF2B-A44-N	SF2B-A44SL	1752	1752	44
	SF2B-A48-P	SF2B-A48-N	SF2B-A48SL	1912	1912	48

- Photoelectric Sensors
- Fiber-optic Sensors
- Standard Fibers
- Fiber Sensors Communication Units
- Mark Sensors
- Laser Sensors
- Safety Sensors**
- Pressure & Flow Sensors
- Inductive Proximity Sensors
- Measurement Sensors
- Ionizers / Electrostatic Sensors
- Accessories
- Index
- SF4B

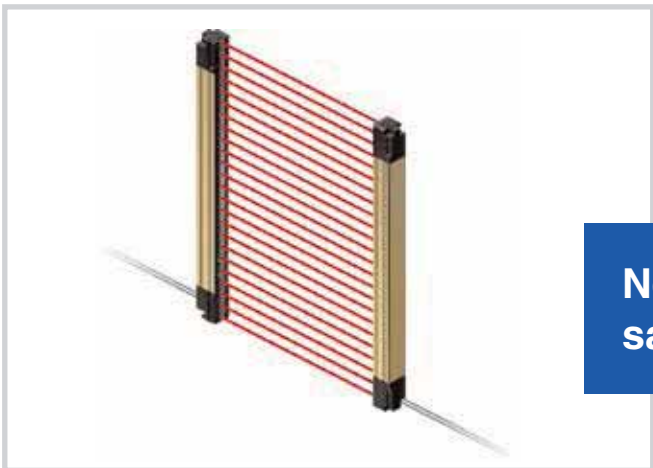

# SF4B<V2>

Type 4 · PLe · SIL3

**New concepts combining greater safety and higher productivity!**

## Features

### ■ Sensor height = protective height

The length of the main unit equals the protective height so that installation is possible in places where space is limited. No dead zone occurs at the joints between light curtains when light curtains are connected in series.

### ■ Finger/hand and arm/foot protection available

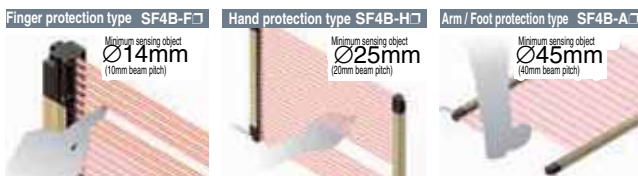

### ■ Response time of 14ms and constant safety distance

A fast response time of 14ms has been achieved regardless of the number of beam channels, the beam axis pitches and the number of units connected in series. This reduces calculation work required for the safety distances.

### ■ A muting control function is provided to increase both safety and productivity

The light curtain is equipped with a muting control function that causes the line to stop only when a person passes through the light curtain, not when an object passes through.

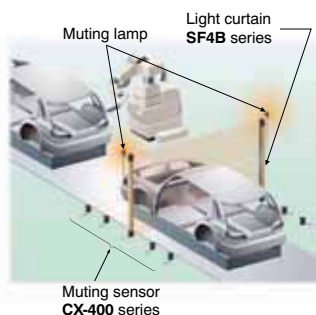

### ■ Built-in safety relay

The light curtain has a built-in external device monitoring function (such as for fused relay monitoring) and an interlock function. The safety circuit is constructed so that a separate safety relay unit is not needed, and the control board is also more compact, both of which contribute to lower costs.

### ■ Improved ambient light immunity

The integrated ELCA function (Extraneous Light Check & Avoid) prevents interference from ambient light or other light curtains and even from welding plants.

### ■ Digital error indicator

If an error occurs, details of the error appear on the digital display so that maintenance can be carried out more quickly.



### ■ Universal design that can be used anywhere in the world

The SF4B series combines PNP transistor output and NPN transistor output in a single model. Overseas equipment that uses PNP, replacement with NPN sensors, factories that are positively grounded, and transfer of equipment overseas are all situations where the control circuits for a single model are suitable for use worldwide.

# Typical applications

## Guarding space around welding robot

A spatter protection hood type perfect for welding devices is also available.

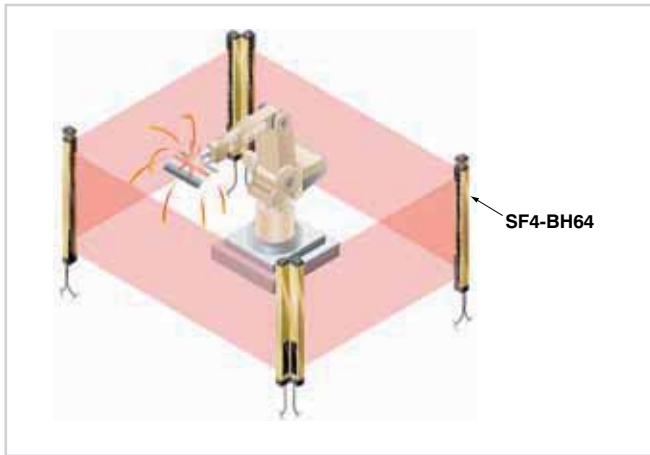

# Technical specifications

Type	Finger protection type	Hand protection type	Arm / Foot protection type
Model no.	SF4B-F□<V2> (Note 1)	SF4B-H□<V2>	SF4B-A□<V2>
Safety category	Type 4, PL e, SIL3		
Sensing height	230 to 1270mm	230 to 1910mm	
Sensing range	0.3 to 7m (depending on type up to 9m)		
Resolution	10mm	20mm	40mm
Minimum sensing object	Ø > 14mm (opaque)	Ø > 25mm (opaque)	Ø > 45mm (opaque)
Power supply voltage	24VDC +/-10%		
Response time	ON -> OFF: max. 14ms / OFF -> ON: max. 90ms		
Control outputs	OSSD1 and OSSD2 (2 x PNP or 2 x NPN open collector transistor, switchable), 200mA or less		
Emitting element	Infrared LED		
Protection	IP67 (Note 2) / IP65 (IEC)		
Ambient temperature	-10 to +55°C		
Material	Frame: Aluminium / Enclosures: Acrylic, Polycarbonate, ABS		
Connection method	Connector		
Dimensions (HxWxD)	Hx30x28mm (H= protective height)		

### Notes:

- 1) For a system configuration, please contact your sales office or service hotline: +49(0)-8024648-737
- 2) IP67 from Vers. 2

- Photoelectric Sensors
- Fiber-optic Sensors
- Standard Fibers
- Fiber Sensors Communication Units
- Mark Sensors
- Laser Sensors
- Safety Sensors**
- Pressure & Flow Sensors
- Inductive Proximity Sensors
- Measurement Sensors
- Ionizers / Electrostatic Sensors
- Accessories
- Index

SF4B

## Sensing height

	Model no.	Protective height (mm)	Installation height (mm)	No. of beam axes
Finger protection type	SF4B-F23<V2>	230	286	23
	SF4B-F31<V2>	310	366	31
	SF4B-F39<V2>	390	446	39
	SF4B-F47<V2>	470	526	47
	SF4B-F55<V2>	550	606	55
	SF4B-F63<V2>	630	686	63
	SF4B-F71<V2>	710	766	71
	SF4B-F79<V2>	790	846	79
	SF4B-F95<V2>	950	1006	95
	SF4B-F111<V2>	1110	1166	111
	SF4B-F127<V2>	1270	1326	127
	Hand protection type	SF4B-H12<V2>	230	286
SF4B-H16<V2>		310	366	16
SF4B-H20<V2>		390	446	20
SF4B-H24<V2>		470	526	24
SF4B-H28<V2>		550	606	28
SF4B-H32<V2>		630	686	32
SF4B-H36<V2>		710	766	36
SF4B-H40<V2>		790	846	40
SF4B-H48<V2>		950	1006	48
SF4B-H56<V2>		1110	1166	56
SF4B-H64<V2>		1270	1326	64
SF4B-H72<V2>		1430	1486	72
SF4B-H80<V2>		1590	1646	80
SF4B-H88<V2>		1750	1806	88
SF4B-H96<V2>		1910	1966	96
Arm / Foot protection type		SF4B-A6G<V2>	244	334
	SF4B-A8G<V2>	324	414	8
	SF4B-A10G<V2>	404	494	10
	SF4B-A12G<V2>	484	574	12
	SF4B-A14G<V2>	564	654	14
	SF4B-A16G<V2>	644	734	16
	SF4B-A18G<V2>	724	814	18
	SF4B-A20G<V2>	804	894	20
	SF4B-A24G<V2>	964	1054	24
	SF4B-A28G<V2>	1124	1214	28
	SF4B-A32G<V2>	1284	1374	32
	SF4B-A36G<V2>	1444	1534	36
	SF4B-A40G<V2>	1604	1694	40
	SF4B-A44G<V2>	1764	1854	44
SF4B-A48G<V2>	1924	2014	48	





# SF4C

Type 4 · PLe · SIL3

Ultra-slim light curtain safeguards machines without sacrificing productivity

- Photoelectric Sensors
- Fiber-optic Sensors
- Standard Fibers
- Fiber Sensors Communication Units
- Mark Sensors
- Laser Sensors
- Safety Sensors**
- Pressure & Flow Sensors
- Inductive Proximity Sensors
- Measurement Sensors
- Ionizers / Electrostatic Sensors
- Accessories
- Index

SF4C

## Features

### ■ Large, built-in, multi-purpose LED indicators

Large LED bars on each side of the light curtain provide a wide visibility indicator that can be customized for various applications by means of independent external inputs. The indicator can be used as an operation indicator (muting) or job indicator, etc.

### ■ Finger/hand protection

The **SF4C** series covers a sensing height of 160mm to 640mm. This is true for the finger and hand protection types (resolution up to 10 or 20mm).

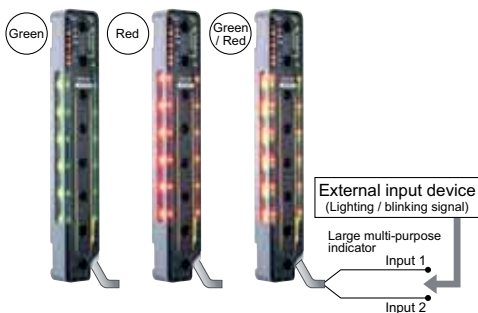

### ■ Can be used in a variety of applications for simplified equipment (large multi-purpose indicator)

Wire-saving when connecting to safety devices. Contact outputs such as emergency stop switches or safety door switches can be connected to the light curtain. Also, by using the handy-controller **SFC-HC**, up to three sets of light curtains can be cascade connected for a consolidated safety output.

### ■ IP67 (IEC)

An IP67 (IEC/JIS) rating is achieved with an ultra-slim size for protection from environmental factors.

### ■ Mutual interference is reduced without need for interference prevention lines

The light curtain is equipped with the ELCA (Extraneous Light Check & Avoid) function, which has been proven to be strong against mutual interference. Because it automatically shifts the scanning time of the light curtain in order to avoid interference, it is not necessary to wire interference prevention lines between machinery.

### ■ A fast response time of 7ms\* for all models

A fast response time of 7ms\* for all models regardless of the number of beam channels. This reduces the safety distance as well as the calculation work required for the safety distance among models with different beam channels.

\* When connecting safety sensors (light curtains, etc.) to the safety input, the response time will be the total time of connected units.

### ■ Safety, productivity, and cost reduction [muting control function]

The muting sensors and muting lamps can be connected directly to the light curtain. Furthermore, the large multi-purpose indicators can be used as muting lamps, which contribute to less wiring troubles, improvement of safety and productivity, and cost reduction.

## Typical applications

### Use of internal muting lamp

There is no need to buy and install a separate muting lamp.

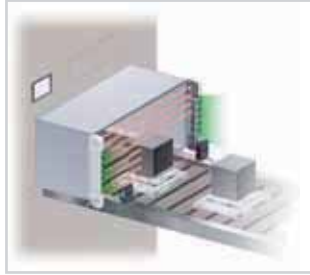

### Selective muting area

Separate muting control function for each beam channel.

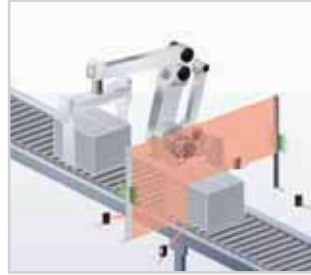

### Industry first!

Wire-saving when connecting to safety devices (safety input function).

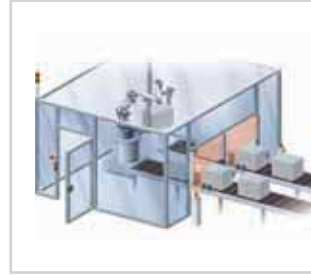

## Technical specifications

Type	Finger protection type	Hand protection type
Model no.	SF4C-F□ (Note)	SF4C-H□
Safety category	Type 4, PLc, SIL3	
Sensing height	Depending on types (160 to 640mm)	
Sensing range	0.1 to 3m	
Resolution	10mm	20mm
Minimum sensing object	Ø > 14mm (opaque)	Ø > 25mm (opaque)
Power supply voltage	24V DC +10/-15%	
Control outputs	OSSD1 and OSSD2 (2x PNP or 2x NPN transistor outputs with open collector, switchable, 200mA or less)	
Response time	7ms or less / OFF response:	
Rated current consumption	270mA or less (depending on type)	
Protection	IP67 / IP65 (IEC)	
Ambient temperature	-10 to +55°C	
Material	Polycarbonate	
Connection method	5m cable or 0.5m cable with connector	
Dimensions (HxWxD)	Hx13.2x30mm (H= protective height)	

**Note:** For a system configuration, please contact your sales office or service hotline: +49(0)-8024648-737.

### Sensing height

Finger protection type	Model no.		Protective height (mm)	Installation height (mm)	No. of beam axes
	Cable type	Cable with connector			
Finger protection type	SF4C-F15	SF4C-F15-J05	160	160	15
	SF4C-F23	SF4C-F23-J05	240	240	23
	SF4C-F31	SF4C-F31-J05	320	320	31
	SF4C-F39	SF4C-F39-J05	400	400	39
	SF4C-F47	SF4C-F47-J05	480	480	47
	SF4C-F55	SF4C-F55-J05	560	560	55
	SF4C-F63	SF4C-F63-J05	640	640	63

Hand protection type	Model no.		Protective height (mm)	Installation height (mm)	No. of beam axes
	Cable type	Cable with connector			
Hand protection type	SF4C-H8	SF4C-H8-J05	160	160	8
	SF4C-H12	SF4C-H12-J05	240	240	12
	SF4C-H16	SF4C-H16-J05	320	320	16
	SF4C-H20	SF4C-H20-J05	400	400	20
	SF4C-H24	SF4C-H24-J05	480	480	24
	SF4C-H28	SF4C-H28-J05	560	560	28
	SF4C-H32	SF4C-H32-J05	640	640	32

# SD3-A1

Type 3 · PLd · SIL2

Monitor dangerous areas for unauthorized entry using flexible detection zones!



## Features

### ■ Freely configurable zones

Two zones can be monitored with the **SD3-A1**: the warning zone within a radius of 15m, and the protection zone within a radius of 4m. You can configure the contours of these zones to perfectly accommodate any application. You can configure up to eight zone patterns and switch between them at any given time, even during operation. This flexible zone configuration can be done by PC.

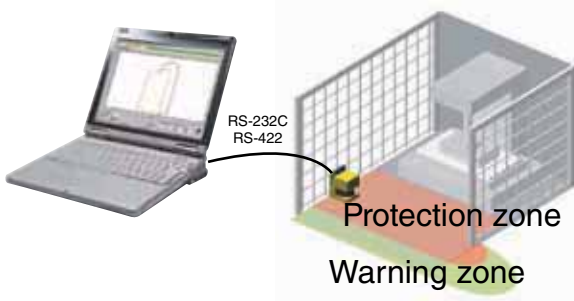

### ■ Monitors beam misalignment after installation of safety laser scanner

By activating the reference boundary function which enables constant detection of stationary objects, the safety laser scanner memorizes the position of stationary objects, and monitors for beam misalignment after installation.

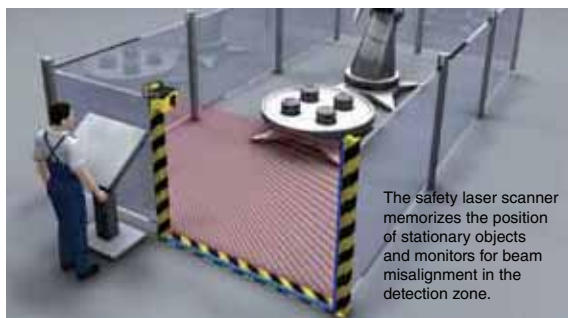

The safety laser scanner memorizes the position of stationary objects and monitors for beam misalignment in the detection zone.

### ■ Adjustment of response times enables interference prevention

The response time can be adjusted from 80 to 640ms. Mutual interference can be prevented by adjusting the response time when setting up multiple safety laser scanners in close vicinity.



### ■ Memorized configurations make post-maintenance recovery easy (optional)

Configurations can be saved in the optional configuration plug's built-in memory and reloaded after maintenance or exchanging safety laser scanners.

Photoelectric Sensors

Fiber-optic Sensors

Standard Fibers

Fiber Sensors  
Communication Units

Mark  
Sensors

Laser Sensors

Safety  
Sensors

Pressure & Flow  
Sensors

Inductive Proximity  
Sensors

Measurement Sensors

Ionizers /  
Electrostatic Sensors

Accessories

Index

SD3-A1

## Typical applications

### Detecting entry into dangerous areas at processing machines

Warning and machine halt zones are implemented to detect workers in dangerous areas.



### Confirming safety around automatically guided vehicles

The scanner is used to slow down the vehicle upon detection in the warning zone and stop the vehicle upon entering the protection zone.

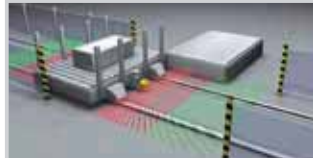

### Detecting presence in a defined field

Install two safety laser scanners to build a protection zone surrounding the object in question. Deactivating the zone is also possible.

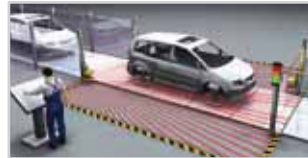

### Guarding the sides of automatic guided vehicles (AGV)

Prevent injuries from a moving AGV. Monitor fallen cargo to avoid collisions.



### Detecting entry into dangerous areas of circular cycle tables

One safety laser scanner can safeguard the front opening where in the past two sets of light curtains were needed.



### Detecting entry into robot working areas

The scanner detects a human body whenever it enters the field.



## Technical specifications

Type		Safety laser scanner				
Model no.		SD3-A1				
Safety category		Type 3, PLd, SIL2				
Protection zone	Minimum sensing object	ø150mm	ø70mm	ø50mm	ø40mm	ø30mm
	Sensing range (radius)	0 to 4.0m	0 to 4.0m	0 to 2.8m	0 to 2.2m	0 to 1.6m
Warning zone	Minimum sensing object	ø150mm (fixed)				
	Sensing range (radius)	0 to 15m				
Scanning angle		190° / 180° (by setting)				
Measurement zone		Max. (radius) 50m				
Number of zone settings		Max. 7 + 1 (without detection zone)				
Min. zone setting range		200mm				
Power supply voltage		24VDC+20/-30%				
Control outputs		OSSD 1 and OSSD 2 (2x PNP open collector transistor outputs; max. 250mA)				
Laser protection class		Class 1 (IEC)				
Protection		IP65 (IEC)				
Ambient temperature		0 to +55°C				
Material		Main body: die-cast aluminum, Scanner window: plastic				
Accessories		15-pin connector, 9-pin connector, installation and instruction manual, configuration and evaluation software, mounting screws				

# SQ4

Type 4 · PLe · SIL3

## Safe leakage monitoring



## Features

### ■ Two-stage monitoring

The **SQ4** series' two-stage monitoring enables the sensors to differentiate between minor leaks that have just started and serious leaks that require immediate action.

### ■ Also suitable for chemicals

In addition to the standard type, types with PFA enclosures that are resistant to the most common chemicals are also available.

### ■ Operating without control unit

The sensor SQ4 can operate alone without a control unit, meaning it can replace existing systems easily.

### ■ Networking

You can connect up to four SQ4 leakage sensors with the control unit SQ4-C11, minimizing wiring efforts.

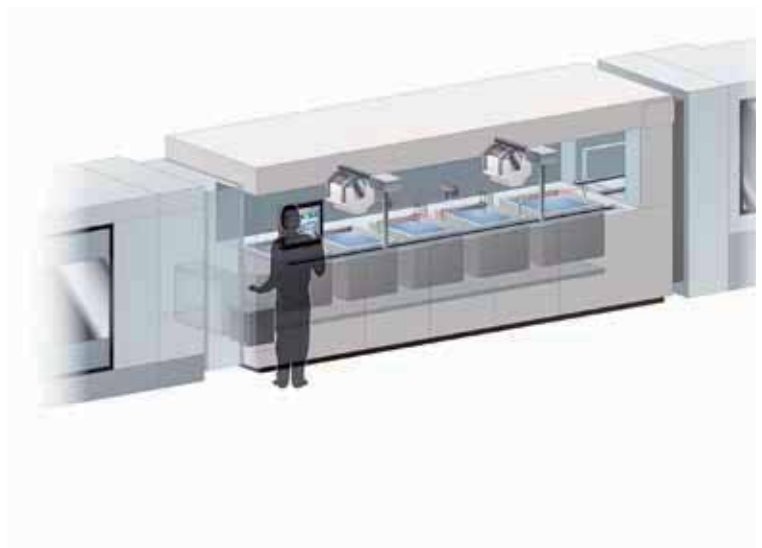

Photoelectric Sensors

Fiber-optic Sensors

Standard Fibers

Fiber Sensors  
Communication Units

Mark  
Sensors

Laser Sensors

Safety  
Sensors

Pressure & Flow  
Sensors

Inductive Proximity  
Sensors

Measurement Sensors

Ionizers/  
Electrostatic Sensors

Accessories

Index

SQ4

## Technical specifications

### ■ Sensor heads

Type		Water	Other liquids
Model no.	NPN output	SQ4-A21-N	SQ4-A22-N
	PNP output	SQ4-A21-P	SQ4-A22-P
Safety category		Type 1 PLc, SIL1 (with controller Type 4, PLc, SIL3)	
Tolerable liquids		Water	Sulfuric acid, ammonia, galden, fluorinert, fluorine, etc.
Response time		10ms or less (ON → OFF)	
Power supply voltage		12 to 24V DC ±10%	
Output		PNP / NPN open-collector transistor, 50mA or less	
Rated current consumption		30mA or less	
Material		Polypropylene	PFA
Protection		IP65/IP67 (IEC)	
Ambient temperature		-10 to +55°C	
Connection method		2m cable	
Dimensions (ØxH)		35.8x18.7mm	

### ■ Controller

Model no.	SQ4-C11
Safety category	Type 4, PLc, SIL3
Response time	20ms or less (ON → OFF)
Power supply voltage	24V DC +10/-15%
Control outputs	OSSD1 and OSSD2 (2x PNP or 2x NPN transistor outputs with open collector, switchable, 200mA or less)
Features	Interlock / Lockout cancel / Test input / External device monitor / Safety input
Rated current consumption	200mA or less
Protection	IP20 (IEC)
Ambient temperature	-10 to +55°C
Material	Polycarbonate/ABS
Connection method	Connector (sensors), terminal block
Dimensions (HxWxD)	100x48x66mm

**Note:** For a system configuration, please contact your sales office or service hotline: +49(0)-8024648-737

# SF-C10



Less setup time for safety light curtains

## Features

### ■ Supports both PNP and NPN polarities

A single unit can be used for PNP / NPN input switching, reducing the number of parts that need to be registered.

### ■ Removable terminal blocks reduce maintenance time

Removable terminal blocks are used. This reduces the work required for reconnecting wiring during maintenance.

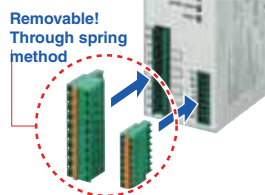

### ■ Metal enclosure with an IP65 (IEC) protective structure

The strong metal enclosure has a built-in safety relay. It has an IP65 (IEC) protective structure so that it can be set up individually without needing to be inserted into a control panel.



Connector in metal housing

### ■ Slim design

22.5mm thickness for insertion even into narrow spaces inside panels.



### ■ Three safety circuit systems packaged into a single unit!

Three safety circuit systems are packaged into a single unit: light curtain output circuit, muting control circuit, and emergency stop circuit.



Photoelectric Sensors

Fiber-optic Sensors

Standard Fibers

Fiber Sensors  
Communication Units

Mark  
Sensors

Laser Sensors

Safety  
Sensors

Pressure & Flow  
Sensors

Inductive Proximity  
Sensors

Measurement Sensors

Ionizers /  
Electrostatic Sensors

Accessories

Index

SF-C10

# DP-100

## Pressure sensors with dual display



## Features

- The current and threshold values can be checked at the same time!

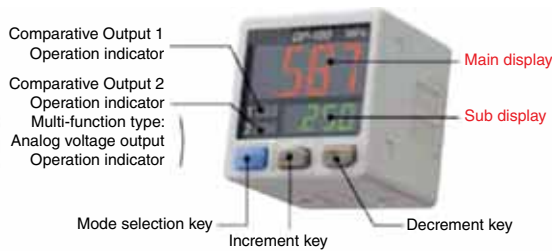

- Dual display allows direct setting of threshold value

Equipped with a 30mm square compact dual display. Because the current and threshold value can be checked at the same time, the threshold value can be set and checked smoothly without having to switch screen modes.



- 3-color display (red, green, orange)

The main display color changes depending on the output status (ON/OFF operation) and while settings are being made. The sensor status can therefore be understood easily, and operating errors can be reduced.

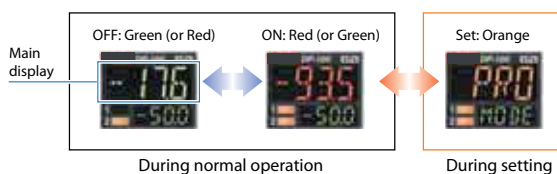

- Easy-to-read digital display!

A clear 12-segment make numbers and letters easy to read.



- High performance

The low pressure type displays measurements in 0.1kPa at a resolution of 1/2000 and has a response time of 2.5ms (variable up to 5000ms). Moreover it boasts  $\pm 0.5\%$  F.S. temperature characteristics and  $\pm 0.1\%$  F.S. repeatability.

For low pressure

- Copy function saves time and reduces human error

Sensors can be connected to a master sensor one by one and settings copied to them. When making the same settings for multiple sensors, this prevents setting errors from occurring and reduces the number of changes required to instruction manuals when equipment designs are changed.

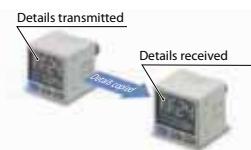

- Equipped with auto-reference and remote zero-adjustment functions A precise pressure management is possible

If the reference pressure of the device changes, the auto-reference function partially shifts the comparative output judgment level by the amount that the reference pressure shifts and resets the display value to zero. These functions are ideal for places where the reference pressure fluctuates wildly, or where fine settings are desired.



# Typical applications

## Confirming suction of electronic component

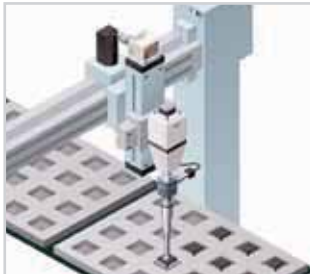

## Confirming reference pressure



## Leak test for PET bottles



# Technical specifications

## Cable types

Type		Standard		High-function controller		
Model no.	Asian	DP-101 (Note 1)	DP-102	DP-101A	DP-102A	
	European	DP-101-E-P	DP-102-E-P	DP-101A-E-P	DP-102A-E-P	
	G 1/8 male thread	Short port type	DP-101-FE-P	DP-102-FE-P	DP-101A-FE-P	DP-102A-FE-P
	M5 female thread		DP-101-M-P	DP-102-M-P	DP-101A-M-P	DP-102A-M-P
Rated pressure range (Note 3)		-1bar to +1bar (-100.0 to +100.0kPa)	-1bar to +10bar (-0.1 to +1.0MPa)	-1bar to +1bar (-100.0 to +100.0kPa)	-1bar to +10bar (-0.1 to +1.0MPa)	
Applicable fluid		Non-corrosive gas				
Power supply voltage		12 to 24V DC ±10%				
Output		PNP / NPN open-collector transistor, 100mA or less				
Response time		2.5ms, 5ms, 10ms, 25ms, 50ms, 100ms, 250ms, 500ms, 1000ms, 5000ms, selectable by key operation				
Display		3-color LCD display, 12 segments, 4 digits				
Pressure port		Asian: M5 female thread + R (PT) 1/8 male thread European: M5 female thread + G 1/8 male thread				
Connection method		Connector (Note 2)				
Dimensions (HxWxD)		30x30x42.5mm				
Accessories		CN-14A-C2 Connector attached cable 2m, 1 pc.				

### Notes:

- Suffix E = Air supply M5 female thread and G 1/8 male thread  
Suffix FE = Standard flat attachment  
Suffix M = M5 short port type  
Suffix P = PNP output
- CN-14A-C2 cable 2m is included in delivery
- Where measurement conditions have not been specified precisely, the conditions used were an ambient temperature of +20°C. Reference pressure=1atm

## M8 connector types

Type	Standard		Multifunction	
Model no.	DP-111-E-P-J	DP-112-E-P-J	DP-111A-E-P-J	DP-112A-E-P-J
Rated pressure range (Note 1)	-1bar to +1bar (-100.0 to +100.0kPa)	-1bar to +10bar (-0.1 to +1.0MPa)	-1bar to +1bar (-100.0 to +100.0kPa)	-1bar to +10bar (-0.1 to +1.0MPa)
Applicable fluid	Non-corrosive gas			
Power supply voltage	12 to 24V DC ±10%			
Output	PNP open-collector transistor, 100mA or less			
Response time	2.5ms, 5ms, 10ms, 25ms, 50ms, 100ms, 250ms, 500ms, 1000ms, 5000ms, selectable by key operation			
Analog volt. output / external input	—		Incorporated	
Ambient temperature	-10 to +50°C			
Pressure port	G1/8 male thread + M5 female thread			
Material	Enclosure: PBT (glass fiber reinforced); LCD display: Acrylic; Pressure port: Stainless steel (SUS303); Thread part: Brass (nickel plated); Switch part: Silicone rubber, M8 connector part: Nickel-plated brass/brass gold plated contacts			
Connection method	M8 connector (Note 2)			
Dimensions (HxWxD)	30x30x47.5mm			
Accessories	Unit selection plate: 1 set			

### Notes:

- Where measurement conditions have not been specified precisely, the conditions used were an ambient temperature of +20°C. Reference pressure=1atm
- Cable not included in delivery, please select under accessories (page 125).

- Photoelectric Sensors
- Fiber Optic Sensors
- Standard Fibers
- Fiber Sensor Communication Units
- Mark Sensors
- Laser Sensors
- Safety Sensors
- Pressure & Flow Sensors**
- Inductive Proximity Sensors
- Measurement Sensors
- Ionizers/ Electrostatic Sensors
- Accessories
- Index
- DP2**



# DP2

## High-performance digital pressure sensors

### Features

- High accuracy, high resolution, high speed  
The **DP2** series reaches a response time of 2.5ms at a resolution of 1/1000. It enables high-precision detection with extraordinary repeatability and temperature characteristics.

- Clearly visible LED display with 3.5 digits  
Bright red LED 7-segment display having 3.5 digits, 10mm high. The displayed figures are remarkably noticeable not only in a dark area, but also in a well-lit place.

- Setting with easy key operation  
Initialization and threshold value settings are easily done by key operation while seeing the values on the display.

- Six pressure units available for selection  
The pressure unit can be selected from among six different systems to suit your requirement.

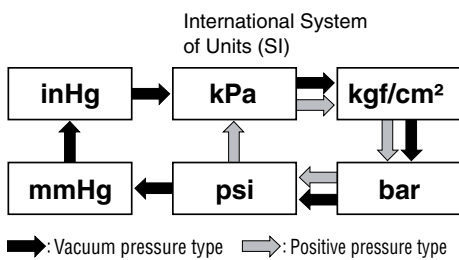

- Four output modes enable versatile pressure level control

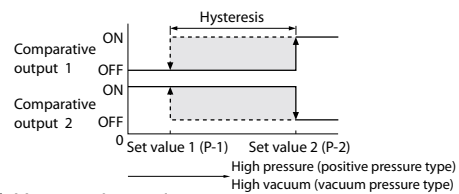

1) Hysteresis mode

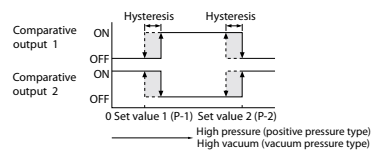

2) Window comparator mode

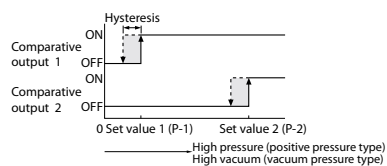

3) Dual output mode

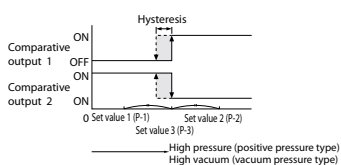

4) Automatic sensitivity setting mode

# Typical applications

## Verifying proper workpiece seating

Air is supplied from under the base, and the pressure sensor checks for air leakage from any gap between the base and the workpiece.

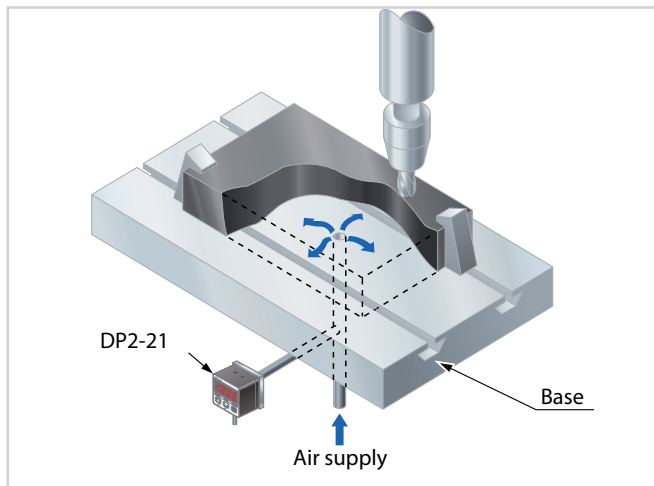

## Detecting broken spool

The pressure sensor detects if a spool is chipped by sensing even slight air leakage in the air-supply system shown below.

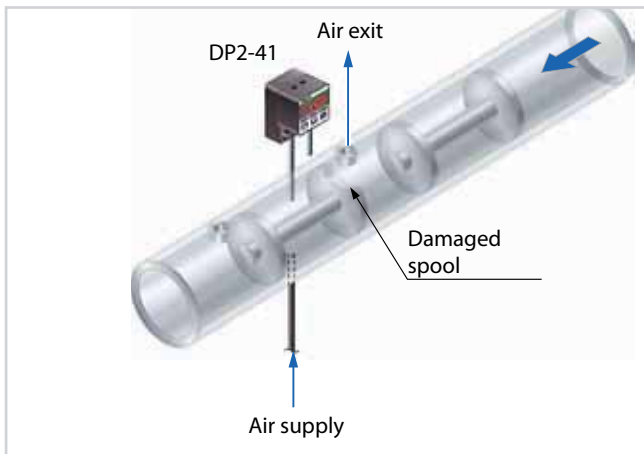

# Technical specifications

Type		Vacuum pressure				Positive pressure					
		- 1bar (- 100.0kPa)				1bar (100.0kPa)			10bar (1.0MPa)		
		Standard	Light weight	Flat	IP67	Standard	Flat	IP67	Standard	Flat	IP67
Model no.	Asian	DP2-20	DP2-80	—	DP2-60	DP2-21	DP2-41	DP2-61	DP2-22	DP2-42	DP2-62
	European	—	—	DP2-40E	DP2-60E	—	DP2-41E	DP2-61E	—	DP2-42E	DP2-62E
	Type of pressure	Gauge pressure (Note)									
Rated pressure		0 bis -1bar (0 to -100.0kPa)				0 to +1bar (0 to +100.0kPa)			0 to 10bar (0 to 1.0MPa)		
Applicable fluid		Non-corrosive gas									
Power supply voltage		12 to 24VDC +10%/ -15%									
Output		Asia, (Standard, light weight, flat and IP67 types) PNP or NPN open-collector transistor, 100mA or less Output voltage: 1 to 5V (overrated pressure range)									
Analog voltage output		Zero point: within 1V ± 5% F.S. Span: within 4V ± 5% F.S. Linearity: within ± 1% F.S. Output impedance: approx. 1kΩ									
Pressure port	Asian	Standard, Flat and IP67 types: Rc (PT) 1/8 female thread, Light weight type: M5 female thread									
	European	Flat and IP67 types: G (PF) 1/8 female thread									
Material		Front case: ABS, Rear case: PPS (glass fiber reinforced), Display surface: acrylic Pressure port: Die-cast zinc alloy (Light weight type: POM (glass fiber reinforced)) Pressure port: nickel-plated brass Front cover (IP67 type only): Polycarbonate									
Connection method		2m cable									
Dimensions (HxWxD)		DP2-2□: 31.6x31.6x38.5mm DP2-80: 30x30x33.5mm DP2-4□: 30x30x35mm DP2-6□: 71.5x46x43mm									
Accessories		Hexagon-socket-head plug for pressure port: 1 pc. (Standard type only), Pressure unit label: 1 pc.									

Note: Reference pressure 1atm

- Photoelectric Sensors
- Fiber Optic Sensors
- Standard Fibers
- Fiber Sensors Communication Units
- Mark Sensors
- Laser Sensors
- Safety Sensors
- Pressure & Flow Sensors**
- Inductive Proximity Sensors
- Measurement Sensors
- Ionizers / Electrostatic Sensors
- Accessories
- Index

DP2

# DP4

Pressure sensor for front panel mounting



## Features

### ■ Lightweight, compact design

A compact form specifically designed for mounting on an equipment panel.

It uses only half the space of our conventional product and boasts a weight of just 30g (cable excluded).

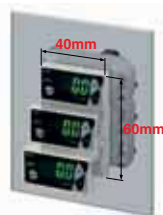

### ■ Bright, easy-to-view 2-color display

The large, 2-color digital display can be read quickly. Additionally, the output status is indicated by the display color:

Output ON = Red,

Output OFF = Green.

### ■ Supplied with a simple-to-mount panel mounting bracket

A panel mounting bracket enables simple mounting of the sensor onto the panel surface, thus contributing to the total cost reduction.

### ■ Data bank

You can save up to two values and select them with the help of the keys.



## Typical applications

### Vacuum level confirmation for vacuum moulding

Detects the smallest air leaks from pinholes and other minute imperfections.

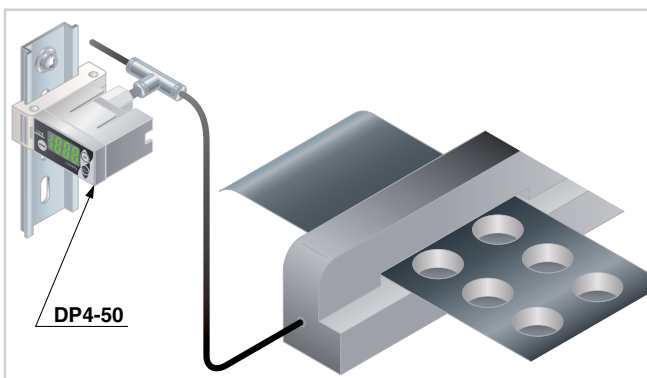

### Confirming suction of wafer

While a wafer is being carried, the pressure sensor checks the vacuum level in the vacuum pad to verify that the wafer is being securely gripped.

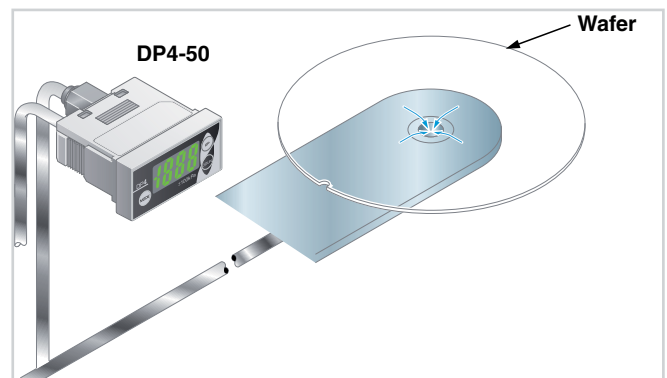

# Technical specifications

Type	Vacuum pressure		Positive pressure		Compound pressure type	
	-1bar (-100.0kPa)		10bar (1.0MPa)		±1bar (±100.0kPa)	
	NPN output	PNP output	NPN output	PNP output	NPN output	PNP output
Model no.	DP4-50	DP4-50P	DP4-52	DP4-52P	DP4-57	DP4-57P
Type of pressure	Gauge pressure (Note 1)					
Rated pressure	0 to -1bar (0 to -100.0kPa)		0 to 10bar (0 to 1.0MPa)		-0 to +1bar (-1 to +100.0kPa)	
Applicable fluid	Non-corrosive gas					
Power supply voltage	12 to 24VDC +10% / -15%					
Output	PNP / NPN open-collector transistor, 100mA or less					
Response time	2ms, 16ms, 128ms, 512ms or less (selectable by key operation)					
Protection	IP40 (IEC)					
Pressure port	M5 female thread					
Material	Front case: ABS, LCD display selection: PET, Rear case: PBT, M5 threaded part: Brass (nickel plated)					
Connection method	Connector (Note 2)					
Dimensions (HxWxD)	20x40x49mm					
Accessories	Panel mounting bracket (MS-DP-1): 1 set, Pressure unit label: 1 pc., Connector: 1 set (Housing: 1 pc., Connector pins 3 pcs.)					

## Notes:

- 1) Reference pressure 1atm.
- 2) Cable is not included in delivery. Please select under accessories (page 125).

Photoelectric Sensors

Fiber Optic Sensors

Standard Fibers

Fiber Sensors Communication Units

Mark Sensors

Laser Sensors

Safety Sensors

Pressure & Flow Sensors

Inductive Proximity Sensors

Measurement Sensors

Ionizers / Electrostatic Sensors

Accessories

Index

DP4

# DP-M



Precisely detects minut differences in pressure levels

## Features

### ■ High accuracy and resolution

Due to differential pressure sensing, the pressure can be set with a high resolution of 0.01kPa.D (1mm H2O.D) over a pressure range of 0 to 2.00kPa.D (0 to 204mm H2O.D) and, moreover, the detection accuracy is within  $\pm 1\%$  F.S.

### ■ Bright digital display

Three bright red 7-segment LEDs, 12mm high, are incorporated in the compact body.

### ■ Simple key setting

Initialization or pressure settings can be easily done with key operation while looking at the display.

### ■ Analog current output

An analog current output (4-20mA) enables real-time monitoring and control actions.

## Typical applications

### Detection of blocked filters

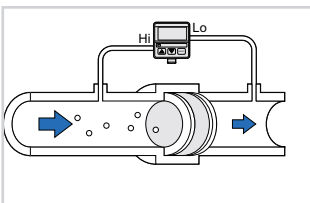

## Technical specifications

Type	Standard type	With analog output
Model no.	DP-M2	DP-M2A
Type of pressure	Differential pressure	
Rated pressure	0 bis 2.00kPa.D (0 bis 204mmH2O.D)	
Applicable fluid	Non-corrosive gas	
Power supply voltage	12 to 24VDC +10% / -15%	
Output	NPN open-collector transistor, 100mA or less	
Analog current output	-	Output current: 4 to 20mA (from 0 to 1.96kPa.D (0 to 200mmH2O.D) Zero point: within 4mA $\pm$ 1% F.S. Span: within 16mA $\pm$ 3% F.S. Linearity: within $\pm$ 1% F.S. Load resistance: 0 to 250 $\Omega$
Ambient temperature	0 to +50°C	
Pressure port	$\phi$ 4.8mm resin	
Material	Front case: ABS, Rear case: ABS, LED display: Acrylic, Pressure port: PA	
Connection method	0.18mm <sup>2</sup> , 3-wire cable, 2m	0.18mm <sup>2</sup> , 4-wire cable, 2m

Photoelectric Sensors
Fiber Optic Sensors
Standard Fibers
Fiber Sensors Communication Units
Mark Sensors
Laser Sensors
Safety Sensors
<b>Pressure &amp; Flow Sensors</b>
Inductive Proximity Sensors
Measurement Sensors
Ionizers / Electrostatic Sensors
Accessories
Index
<b>DPC-100/DPH-100</b>

# DPC-100/ DPH-100

**Single-axis type digital pressure sensor with optional dual 3-color display**



## Features

### ■ Automatic sensor head recognition

The controller automatically recognizes sensor heads when they are connected, even if their rated pressure ranges are different.

### ■ Dual display and direct setting

The dual display allows you to check current and threshold values simultaneously.

To facilitate setting operations, three modes have been devised:

- "RUN mode" is for operation settings that are carried out daily
- "MENU SETTING mode" for basic settings
- "PRO mode" for special and detailed settings

Controllers can be connected to a master controller one by one, and the master can transmit settings to the slave controllers. This significantly reduces time required when you need to make multiple, identical settings, or during production changeovers. Moreover, it reduces the possibility for error in such cases.

### ■ Direct installation using a hexagonal wrench

The sensor head is tightened with a hexagonal wrench, making installation easy, especially in tight spaces.



## Typical applications

### Leak test



### Reference pressure checking



### Monitoring vacuum pressure

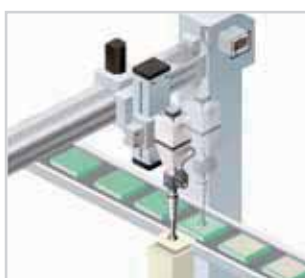

## Technical specifications

### Sensor heads

Type	Standard ±1bar (±100kPa)			Positive pressure ±1bar (±1.0MPa)		Vacuum pressure -1bar (-100kPa)		
Model no.	DPH-101	DPH-101-M3	DPH-101-M5	DPH-102	DPH-102-M5	DPH-103	DPH-103-M3	DPH-103-M5
Type of pressure	Gauge pressure (Note 1)							
Rated pressure	-1 to +1bar (-100.0 to +100.0kPa)			0 to 10bar (0 to +1.0MPa)		0 to -1bar (0 to -100.0kPa)		
Pressure resistance	5bar (500kPa)			15bar (1.5MPa)		5bar (500kPa)		
Applicable fluid	Air, non-corrosive gas							
Power supply voltage	12 to 24V DC ±10%							
Analog voltage output	Output voltage: 1 to 5V (overrated pressure range)							
Protection	IP40 (IEC)							
Ambient temperature	0 bis +50°C							
Pressure port	DPH-101: R1/8 male thread + M5 female thread, DPH-101-M3: M3 male thread (for installing gasket) DPH-101-M5: M5 male thread (for installing gasket)							
Rated current consumption (without load)	15mA or less							
Material	Front case: PBT, Rear case: PBT (glass fiber reinforced), Pressure port: stainless steel (SUS303), O-ring: NBR, Pressure element silicon diaphragm, PPS							
Connection method	Cable, 2m with attached connector							
Dimensions (HxWxD)	23x13.2x 23.4mm	17x10x 20.5mm	17.5x10x 20.5mm	23x13.2x 23.4mm	17.5x10x 20.5mm	23x13.2x 23.4mm	17x10x 20.5mm	17.5x 10x 20.5mm
Accessories	Connector (e-CON): 1 pc.							

### Controller

Type	NPN output	PNP output
Model no.	DPC-101	DPC-101-P
Applicable sensor head	DPH-101□, DPH-102□, DPH-103□	
Rated pressure	Compound pressure type: -1 to +1bar (-100.0 to +100.0kPa) Positive pressure: 0 to 10bar (0 to +1.0MPa) Vacuum pressure: 0 to -1bar (0 to -100.0kPa)	
Power supply voltage	12 to 24V DC ±10%	
Output	PNP or NPN open-collector transistor, 100mA or less	
Power consumption	Normal operation: 960mW or less (Current consumption 40mA or less at 24V supply voltage) ECO mode (STD): 720mW or less (Current consumption 30mA or less at 24V supply voltage) ECO mode (FULL): 600mW or less (Current consumption 25mA or less at 24V supply voltage) Excluding the current consumption of sensor head and analog output current	
Ambient temperature	-10 to +50°C	
Material	Enclosure: PBT (glass fiber reinforced), LCD display: Acrylic, Threaded part: Brass (nickel plated) Switch part: silicon rubber	
Protection	IP40 (IEC)	
Connection method	Connector (Note 2)	
Dimensions (HxWxD)	30x30x29.2mm	
Accessories	CN-66A-C2 Cable (2m) with attached connector Pressure unit label: 1 set	

#### Notes:

- Reference pressure 1atm
- CN-66A-C2 cable 2m is included in delivery





# DPC-L100 / DPH-L100

Powerful and simple high-precision  
detection of fluid and air pressure

## Features

### ■ Head-separated sensor

The sensor head is very flexible and can be used with or without the control unit. High-precision measuring is possible with an analog current output of 1 to 5V and extremely accurate detection of 1% F.S.

### ■ Stainless steel construction

The enclosure is made of stainless steel and hence suitable in a wide range of applications. An oil-less, hermetically enclosed diaphragm prevents the fluids from being polluted. An integrated throttle controls the pressure and prevents damage by excess pressure.

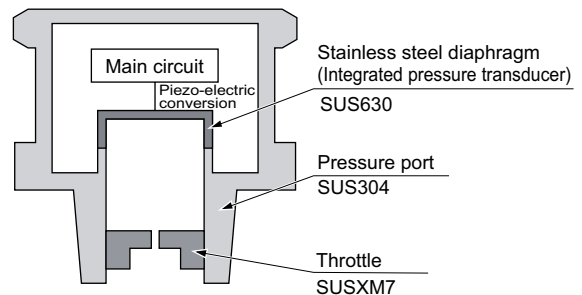

### ■ Wide pressure ranges

Various sensor heads for different pressure ranges from vacuum pressure to positive pressure (up to 500bar/50MPa) are available. With the control unit, the pressure range can be output linearly as voltage or current.

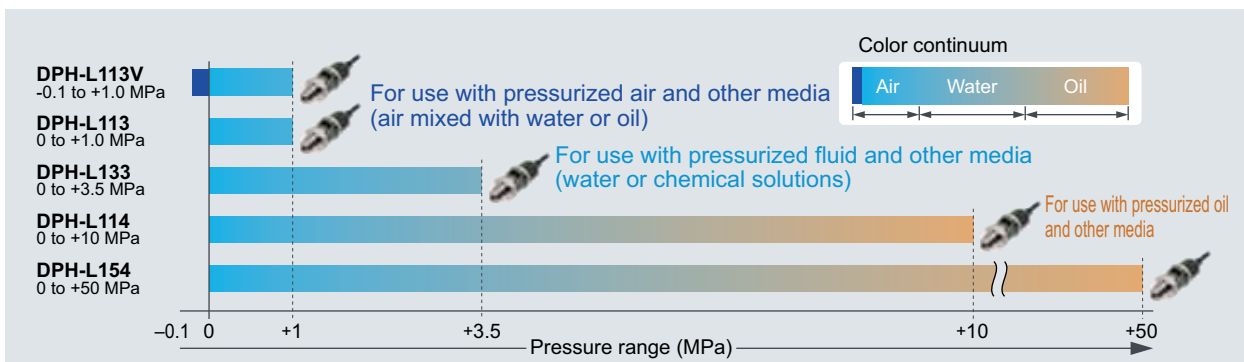

Photoelectric  
Sensors

Fiber Optic  
Sensors

Standard Fibers

Fiber Sensors  
Communication  
Units

Mark  
Sensors

Laser Sensors

Safety  
Sensors

Pressure & Flow  
Sensors

Inductive Proximity  
Sensors

Measurement  
Sensors

Ionizers/  
Electrostatic  
Sensors

Accessories

Index

DPC-L100 /  
DPH-L100

## Typical applications

**Transport of glass sheets after washing (pressurized air containing water droplets)**



**Management of plastic filling machine pressure (pressurized fluid)**



**Management of press pressure (pressurized oil)**



## Technical specifications

### ■ Sensor heads

Type	Compound pressure type	Positive pressure			
Model no.	DPH-L113V	DPH-L113	DPH-L133	DPH-L114	DPH-L154
Rated pressure	-1 to +10bar (-0.1 to +1.0MPa)	0 to +10bar (0 to +1.0MPa)	0 to +35bar (0 to +3.5MPa)	0 to +100bar (0 to +10.0MPa)	0 to +500bar (0 to +50.0MPa)
Applicable fluid	Gases and fluids that do not corrode SUS630, SUS304, or SUSXM7				
Power supply voltage	9 to 36VDC				
Analog voltage output	1 to 5VDC overrated pressure range, Accuracy (Note 1): $\pm 1\%$ F.S. (at $23\pm 2^\circ\text{C}$ )				
Response time	1ms or less				
Medium temperature range	-20 to +70°C		-20 to +125°C		
Pressure port	R1/4 male thread ( ( throttle embedded)				
Protection	IP67 (IEC)				
Ambient temperature	-20 to +70°C		-20 to +80°C		
Material	Diaphragm: stainless steel (SUS630); mounting threaded part: stainless steel (SUS304), Throttle: Stainless steel (SUSXM7)				
Connection method	Cable with connector enclosed, 2m				
Dimensions (ØxD)	24.3x73mm				
Accessories	e- CON connector 1pc.				

Note: Accuracy including linearity, hysteresis and repeatability

### ■ Controller

Type	NPN output	DPC-L101				
Model no.	PNP output	DPC-L101P				
Applicable sensor head		DPH-L113V	DPH-L113	DPH-L133	DPH-L114	DPH-L154
Rated pressure		-1 to +10bar (-0.1 to +1.0MPa)	0 to +10bar (0 to +1.0MPa)	0 to +35bar (0 to +3.5MPa)	0 to +100bar (0 to +10.0MPa)	0 to +500bar (0 to +50.0MPa)
Power supply voltage		12 to 24VDC $\pm 10\%$				
Output		2 PNP or NPN open-collector transistors, 50mA or less				
Analog voltage output		Output voltage 1 to 5V Zero point: within 1V $\pm 5\%$ F.S. (Note 1) Span: 4V $\pm 0.5\%$ F.S. Linearity: within $\pm 0.1\%$ F.S. Output impedance: approx. 1k $\Omega$		Output current: 4 bis 20mA Zero point: within 4mA $\pm 1.0\%$ F.S. (Note 2) Span: 16mA $\pm 1.5\%$ F.S. Linearity: within $\pm 0.1\%$ F.S. Load resistance: 250k $\Omega$ or less		
Response time		5ms, 10ms, 25ms, 50ms, 100ms, 250ms, 500ms, 1000ms, 5000ms selectable by key operation				
Protection		IP40 (IEC)				
Ambient temperature		-10 to +50°C				
Material		Enclosure: PBT, LCD display: acrylic; Mounting threaded part: brass (nickel plated), Switch part: silicone rubber				
Connection method		Connector				
Dimensions (HxWxD)		30x30x25.5mm				
Accessories		CN-66A-C2 Cable, 2m with connector attached, Pressure unit label: 1 set				

#### Notes:

- 1) DPH-L113V: Zerpoint within 1.364V  $\pm 0.5\%$  F.S.
- 2) DPH-L113V: Zerpoint within 5.455mA  $\pm 1.0\%$  F.S.

Photoelectric Sensors
Fiber Optic Sensors
Standard Fibers
Fiber Sensors Communication Units
Mark Sensors
Laser Sensors
Safety Sensors
<b>Pressure &amp; Flow Sensors</b>
Inductive Proximity Sensors
Measurement Sensors
Ionizers / Electrostatic Sensors
Accessories
Index
<b>DP5/DPH</b>



# DP5/DPH

**1/1000 second high-speed response**

## Features

### ■ Response time 1ms

Mounting the detachable head close to the detecting section minimizes piping and enables a response time of 1ms, as well as greatly decreasing tact time delay. In addition, the ultra small and lightweight design of the head means it can easily be mounted on moving sections.

### ■ Sensor head with operation indicator

The sensor head is equipped with an operation indicator. Output ON/OFF can be checked on the sensor head, making it suitable for monitoring operation of the suction head.

### ■ Lightweight, compact design

The controller inherits its lightweight, compact design from the popular DP4 series digital pressure sensors. Control panel setup is low cost and requires minimal space.

### ■ Convenient intermediate cable with connector

Intermediate cable with connectors for the sensor head and the controller simplifies operation and maintenance.

## Typical applications

### IC suction confirmation

With a light 6g head and a 1ms high-speed response time, it can be used with a high-speed mounter.



### Verifying tightening of nut by impact wrench

The pressure sensor senses the back pressure of the impact wrench to verify that the nut is securely tightened.

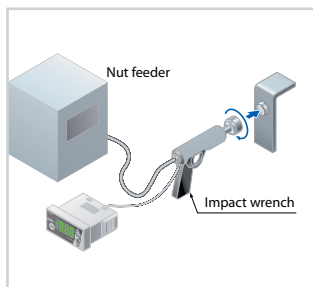

### Verifying clamping pressure of welding hand

Since the pressure sensor incorporates two outputs, the clamping pressure can be classified into three levels: low, OK and high.

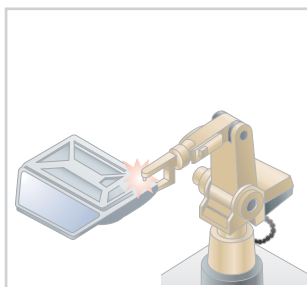

## Technical specifications

### ■ Sensor heads

Type	Vacuum pressure		Positive pressure		Compound pressure type	
	-1bar (-0.1MPa)		10bar (1.0MPa)		±1bar (±0.1MPa)	
Model no.	DPH-A00	DPH-A10	DPH-A02	DPH-A12	DPH-A07	DPH-A17
Type of pressure	Gauge pressure (Note 1)					
Rated pressure	0 to -1bar (0 to -0.1MPa)		0 to 10bar (0 to 1.0MPa)		-1 to +1bar (-0.1 to +0.1MPa)	
Applicable fluid	Non-corrosive gas					
Power supply voltage	12 to 24VDC +10%/-15%					
Analog voltage output	Output voltage: 1 to 5V (overrated pressure range) Zero point: within 1V ± 2% F.S. (vacuum/positive pressure) within 3V ± 3% F.S. (compound pressure type) Span: within 4V ± 3.5% F.S. Linearity: within 1% F.S. Output impedance: approx. 1kΩ					
Pressure port	DPH-A0□: M5 female thread (for installing gasket), DPH-A1□: R (PT) 1/8 male thread / M5 female thread					
Material	Enclosure: PBT, Pressure port: Brass (nickel plated) (only at DPH-A0 stainless steel SUS303)					
Connection method	Connector (Note 2)					
Accessories	Gasket (DPH-A0□ only)					

#### Notes:

- 1) Reference pressure 1 atm.
- 2) Cable is not included in delivery. Please select under accessories (page 125).

### ■ Controller

Type	NPN	PNP
Model no.	DP5-C	DP5-C-P
Applicable pressure sensor head	DPH-A00, DPH-A02, DPH-A07, DPH-A10, DPH-A12, DPH-A17	
Rated pressure	Vacuum pressure: 0 to -1bar (0 to -0.1MPa), positive pressure: 0 to 10bar (0 to 1.0MPa), compound pressure type: -1 to +1bar (0.1 to +0.1MPa)	
Power supply voltage	12 to 24VDC +10%/-15%	
Analog voltage output	Output voltage: 1 to 5V (overrated pressure range) Zero point: within 1V ± 2.5% F.S. (vacuum/positive pressure type) within 3V ± 3.5% F.S. (compound pressure type) Span: within 4V ± 4% F.S. Linearity: within 1% F.S. Output impedance: approx. 1kΩ	
Material	Front case: ABS, LCD display selection: PET, Rear case: PBT	
Connection method	Connector (Note)	
Accessories	Panel mounting bracket (MS-DP-1): 1 set, Connector: 1 set (Housing: 1 pc., Connector: 6 pcs.), Pressure unit label: 1 set, Connector cap: 1 pc.	

Note: Cable is not included in delivery. Please select under accessories (page 125).

# FM-200



## Flow sensor with dual display

## Features

### ■ Easy-to-read, 2-color display with sub display

The 2-color digital display lets you check the operation status of the **FM-200** at a glance. The use of color makes it easy to distinguish between measurement values and functionality.

### ■ High precision of $\pm 3\%$ F.S.

Micro Electro Mechanical System (MEMS) technology allows the sensor to be mounted on a silicon sensor chip. The advantages are as follows: an extremely small heat capacity, a high precision of  $\pm 3\%$  F.S., and a high-speed response time. Two temperature sensors, one on either side of the heater, detect heat distribution and make bidirectional detection possible.

### ■ One sensor for both intake and exhaust

A single sensor can detect flows bidirectionally, or the forward or reverse direction only, making it suitable for a variety of applications.

### ■ Analog voltage output

1 to 5V analog voltage output is incorporated.

### ■ Integrated output and pulse output mode incorporated

The FM-200 series can control and manage flows for a wide variety of applications. The integrated output mode will turn the output ON or OFF at the specified integrated value, allowing you to control air blowing volumes, for example. In pulse output mode, a pulse is generated once at each specified integrated value, allowing you to monitor the amount of air consumed, for example with an Eco-POWER METER.

### ■ Integrated value reset function

In integrated mode, values accumulate over time. As soon as the limit is reached, the digital output is set. This limit value can also be reset by an external input.

### ■ Rattle prevention function

To prevent rattling from rapid changes in flow or from noise, the response time can be set to one of seven steps, from 50ms to approximately 1500ms. The display update period can be changed to 250ms, 500ms or 1000ms in order to eliminate flickering.

### ■ ECO Mode

In ECO mode, the backlight is turned off after approximately one minute if no operation occurs to reduce power consumption.

## Typical applications

### Checking suction



### Checking seating



### Monitoring air blowing and purge gas



## Technical specifications

- Photoelectric Sensors
- Fiber Optic Sensors
- Standard Fibers
- Fiber Sensor Communication Units
- Mark Sensors
- Laser Sensors
- Safety Sensors
- Pressure & Flow Sensors**
- Inductive Proximity Sensors
- Measurement Sensors
- Ionizers/ Electrostatic Sensors
- Accessories
- Index

Type	Plastic housing							
Model no.	PNP output	FM-252-4-P	FM-213-4-P	FM-253-4-P	FM-214-4-P	FM-254-8-P	FM-215-8-P	
	NPN output	FM-252-4	FM-213-4	FM-253-4	FM-214-4	FM-254-8	FM-215-8	
Full scale flow rate		500ml/min	1.0l/min	5l/min	10l/min	50l/min	100l/min	
Display range		±9999999ml		±99999.99l		±999999.9l		
Setting and display resolution		1ml/min		0.01l/min		0.1l/min		
Rated pressure		-0.9 to +7bar (-0.09 to +0.7MPa)						
Pressure resistance		10bar (1.0MPa)						
Applicable fluid		Clean air, compressed air, nitrogen gas						
Linearity		3%F.S.						
Response time		50ms to 1.5s selectable						
Power supply voltage		12 to 24V DC ±10%						
Output		PNP or NPN open-collector transistor, 50mA or less						
Output modes		Output OFF mode, window comparator mode, hysteresis mode, integrated output mode, integrated pulse output mode						
Analog voltage output		1.0 bis 5.0V						
Rated current consumption (without load)		Normal mode: 60mA or less, ECO mode: 40mA or less						
Protection		IP40 (IEC)						
Ambient temperature		0 bis +50°C						
Material		Plastic						
Connection method		Cable with connector enclosed, 1m						
Dimensions (HxWxD)		37x55x17mm				43x55x17mm		
Temperature characteristics		Within ±0.2% F.S./°C (+15°C to +35°C)						
Port size		ø4 push-in				ø8 push-in		

Type	Aluminum housing				
Model no.	PNP output	FM-255-AR2-P	FM-255-AG2-P	FM-216-AR2-P	FM-216-AG2-P
	NPN output	FM-255-AR2	-	FM-216-AR2	-
Full scale flow rate		500l/min		1000l/min	
Display range		±9999999.9l			
Setting and display resolution		1l/min			
Rated pressure		-0.9 to +7bar (-0.09 to +0.7MPa)			
Pressure resistance		10bar (1.0MPa)			
Applicable fluid		Clean air, compressed air, nitrogen gas			
Linearity		3%F.S.			
Response time		50ms to 1.5s selectable			
Power supply voltage		12 to 24V DC ±10%			
Output		PNP or NPN open-collector transistor, 50mA or less			
Output modes		Output OFF mode, window comparator mode, hysteresis mode, integrated output mode, integrated pulse output mode			
Analog voltage output		1.0 bis 5.0V			
Rated current consumption (without load)		Normal mode: 60mA or less, ECO mode: 40mA or less			
Protection		IP40 (IEC)			
Ambient temperature		0 to +50°C			
Material		Resin/Aluminum body type			
Connection method		Cable with connector enclosed, 1m			
Dimensions (HxWxD)		50x80x30mm			
Temperature characteristics		Within ±0.2% F.S./°C (+15°C to +35°C)			
Port size		Rc½ female thread	G½ female thread	Rc½ female thread	G½ female thread
Accessories		CN-F15-C1 cable, 1m with attached connector			

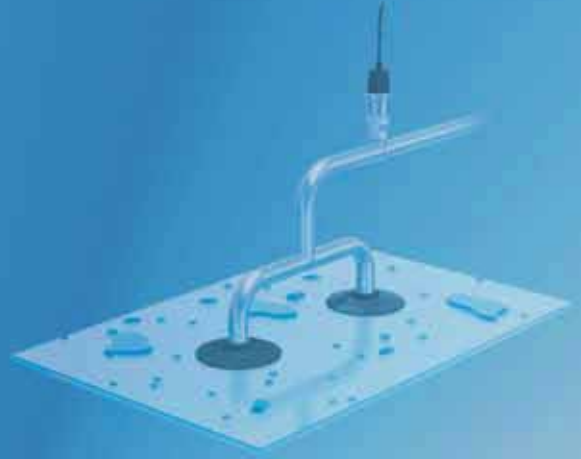

# GX-M



## Cylindrical inductive sensors

## Features

### ■ 2- and 3-wire types

The **GX-M** series consists of 2- and 3-wire types. The 3-wire type is available as a shielded or non-shielded type. The 2-wire type is available as a shielded type and long-range type (up to 15mm). Reduced wiring efforts and space-saving installation reduce costs.

### ■ Various cylinder and thread types

M8, M12, M18 and M30 types means the GX-M series can be used to solve a wide range of automation task. Space-saving, case-by-case integration in production lines, testing and manual work stations.

### ■ Several connection possibilities

You can connect the GX-M sensor with either a 2m cable or M12 plug-in connector.

### ■ Special applications

IP69K (DIN) and IP68 (IEC) types are also available, e.g. for use in machine systems, i.e. the food processing machinery.

## Typical applications

### Control drilling depth

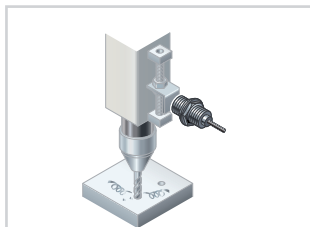

### Detect how far press lowers

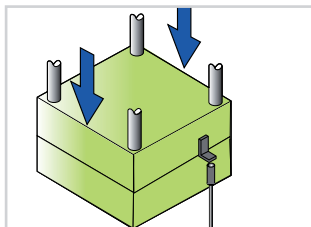

### Count parts

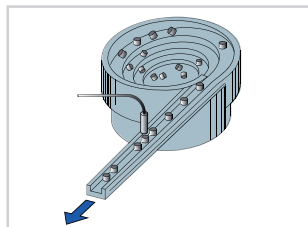

### Control position of components

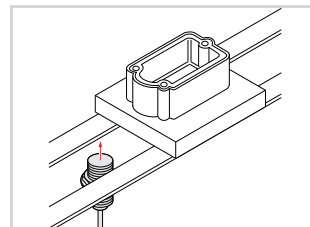



# Technical specifications

## 3-wire type

Type	Shielded				Unshielded			
	GX-M8 (-A/-B)(-P)(-Z) (Note 1,2,3)	GX-M12 (-A/-B)(-P)(-Z)	GX-M18 (-A/-B)(-P)(-Z)	GX-M30 (-A/-B)(-P)(-Z)	GX-MK12 (-A/-B)(-P)(-Z)	GX-MK18 (-A/-B)(-P)(-Z)	GX-MK30 (-A/-B)(-P)(-Z)	
Model no.								
Rated sensing distance (Note 4)	1.5mm ±10%	2mm ±10%	5mm ±10%	10mm ±10%	7mm ±10%	12mm ±10%	22mm ±10%	
Stable sensing distance (Note 4)	0 to 1.2mm	0 to 1.6mm	0 to 4mm	0 to 8mm	0 to 5.6mm	0 to 9.6mm	0 to 17.6mm	
Standard sensing object (Note 5)	8x8mm	12x12mm	18x18mm	30x30mm	24x24mm	24x24mm	45x45mm	
Hysteresis	Max. 15% of measurement distance							
Repeatability	Along sensing axis: max. 5% of measurement distance							
Power supply voltage	12 to 24V DC ±10%							
Output	Open collector transistor – 200mA or less (Note 2)							
Output operation	Normally closed (N.C.) or Normally open (N.O.) (Note 1)							
Switching frequency	5kHz	5kHz	2kHz	1kHz	2.5kHz	1kHz	0.5kHz	
Protection	IP67 (IEC)	IP69K (DIN), IP68 (IEC) 2m cable type; IP67 (IEC) M12 connector type						
Ambient temperature	-25 to +70°C							
Material	Enclosure: Brass (nickel plated), Sensing part: PPS (polyphenylsulfide)							
Connection method	2m cable or M12 plug-in connector type (Note 3)							
Dimensions (ØxL)	2m cable	M8x33mm	M12x35mm	M18x39mm	M30x43mm	M12x55mm	M18x60mm	M30x63mm
	M12 connector	M8x45mm	M12x50mm	M18x50mm	M30x55mm	M12x66mm	M18x72mm	M30x74mm
Accessories	Nuts 2 pcs.							

### Notes:

- 1) Suffix A = Normally open type, suffix B = Normally closed type; i.e. **GX-M8B**.
- 2) Suffix P = PNP type, without suffix = NPN type; i.e. **GX-M8B**.
- 3) Without suffix = 2m cable, suffix -Z = M12 connector type; i.e. **GX-M8B-P-Z**.
- 4) The specified rated sensing distance refers to the standard sensing object. The specified stable sensing distance is the range in which the sensor works reliably even in case of deviations in temperature or voltage.
- 5) Standard sensing object = sheet steel, thickness: 1mm

## 2-wire type

Type	Shielded								
	Standard sensing distance				Large sensing distance				
	GX-M8(-A/-B)-U (Note 1, 2)	GX-M12(-A/-B)-U (-Z)	GX-M18(-A/-B)-U (-Z)	GX-M30(-A/-B)-U (-Z)	GX-ML6(-A/-B)-U	GX-ML12(-A/-B)-U (-Z)	GX-ML18(-A/-B)-U (-Z)	GX-ML30(-A/-B)-U (-Z)	
Model no. (Note 1, 2)									
Rated sensing distance (Note 3)	1.5mm ±10%	2mm ±10%	5mm ±10%	10mm ±10%	2.5 ±10%	4mm ±10%	8mm ±10%	15mm ±10%	
Stable sensing distance (Note 3)	0 to 1.2mm	0 to 1.6mm	0 to 4mm	0 to 8mm	0 to 2mm	0 to 3.2mm	0 to 6.4mm	0 to 12mm	
Standard sensing object (Note 4)	8x8mm	12x12mm	18x18mm	30x30mm	8x8mm	12x12mm	18x18mm	30x30mm	
Hysteresis	Max. 15% of measurement distance								
Repeatability	Along sensing axis: max. 5% of measurement distance								
Power supply voltage	12 to 24V DC ±10%								
Output	Non-contact DC 2-wire type, sink current 1.5 to 100mA, residual voltage max 4.2V (Note 5)								
Output operation	Normally closed (N.C.) or Normally open (N.O.) (Note 1)								
Switching frequency	1kHz	1kHz	1.2kHz	1.3kHz	1.1kHz	1.3kHz	1.5kHz	0.8kHz	
Protection	IP67 (IEC)	IP69K (DIN), IP68 (IEC) 2m cable type; IP67 (IEC) M12 connector type							
Ambient temperature	- 25 to +70°C								
Material	Enclosure: Brass (nickel plated), Sensing part: PPS (polyphenylsulfide)								
Connection method	2m cable	2m cable or M12 plug-in connector type (Note 2)			2m cable	2m cable or M12 plug-in connector type (Note 2)			
Dimensions (ØxL)	2m cable	M8x33mm	M12x35mm	M18x39mm	M30x43mm	M8x33mm	M12x35mm	M18x39mm	M30x43mm
	M12 connector	-	M12x50mm	M18x50mm	M30x55mm	-	M12x50mm	M18x50mm	M30x55mm
Accessories	Nuts 2 pcs.								

### Notes:

- 1) Suffix A = Normally open type, suffix B = Normally closed type; i.e. **GX-M8B-U**.
- 2) Without suffix = 2m cable, suffix -Z = M12 connector type; i.e. **GX-M8B-P-Z**.
- 3) The specified rated sensing distance refers to the standard sensing object. The specified stable sensing distance is the range in which the sensor works reliably even in case of temperature or voltage deviations.
- 4) Standard sensing object = sheet steel, thickness: 1mm.
- 5) If you extend the cable residual voltage may rise.

- Photoelectric Sensors
- Fiber Optic Sensors
- Standard Fibers
- Fiber Sensors Communication Units
- Mark Sensors
- Laser Sensors
- Safety Sensors
- Pressure & Flow Sensors
- Inductive Proximity Sensors
- Measurement Sensors
- Ionizers/ Electrostatic Sensors
- Accessories
- Index
- GX-F/H



# GX-F/H

Stable sensing of work pieces

## Features

### ■ Environmental resistance

This sensor has a long stable sensing range. It is easy to install.

- IP68g protection: water and oil-resistant
- Space-saving installation
- A metal sleeve ensures a secure installation

The new, integrated construction method improves environmental resistance performance.

### ■ The LED indicators are easy to see

A prism with a wide field of view has been developed, thereby greatly improving the visibility of the operation indicators.

### ■ Stable detection

- Large sensing range
- Max. deviation at max. sensing range:  $\pm 8\%$
- Max. deviation with temperature changes:  $\pm 8\%$

## Typical applications

**Checking up/down operation of compact molding equipment**

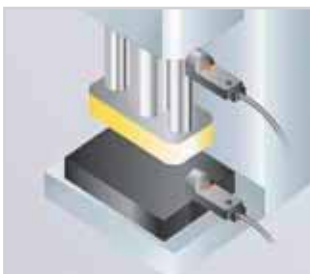

Shock resistance: 5000G

**Sensing presence of metallic objects on a part feeder**



Vibration resistance: 500Hz

**Positioning metal pallets**

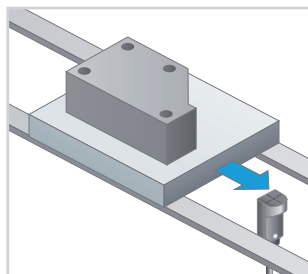

**Muting control with light curtains**



# Technical specifications

Model no.	Side sensing	GX-F6 (-A/ -B)(-I)(-P) (Note 1,2,3)	GX-F8 (-A/ -B)(-I)(-P)	GX-F12 (-A/ -B)(-I)(-P)	GX-F15(-A/ -B)(-I)(-P)	GX-FL15 (-A/ -B)(-I)(-P)
	Top sensing	GX-H6 (-A/ -B)(-I)(-P)	GX-H8 (-A/ -B)(-I)(-P)	GX-H12 (-A/ -B)(-I)(-P)	GX-H15 (-A/ -B)(-I)(-P)	GX-HL15 (-A/ -B)(-I)(-P)
Max. operating distance (Note 4)		1.6mm ±8%	2.5mm ±8%	4mm ±8%	5mm ±8%	8mm ±8%
Stable sensing distance (Note 4)		0 to 1.3mm	0 to 2.1mm	0 to 3.3mm	0 to 4.2mm	0 to 6.7mm
Standard sensing object (Note 5)		12x12mm	15x15mm	20x20mm	20x20mm	30x30mm
Repeatability		<0.04mm				
Interference prevention		Alternate frequency (Note 2)				
Power supply voltage		12 to 24VDC +10% / -15%				
Output		PNP / NPN open-collector transistor, 100mA or less (Note 3)				
Output operation		Normally closed (NC) or Normally open (NO) (Note 1)				
Switching frequency		400Hz	500Hz	250Hz	150Hz	
Protection		IP68 (IEC)				
Ambient temperature		-25 to +70°C				
Material		Enclosure: PBT, display: polyester				
Connection method		1m cable				
Dimensions (HxWxD)	Side sensing	6x6x24.5mm	7.4x8x23mm	7.1x12x27.8mm	8x15x31.5mm	
	Top sensing	6x6x25mm	8.2x8x25mm	12x12x27.4mm	16.5x15x29.5mm	

## Notes:

- 1) Suffix A = Normally open type, suffix B= Normally closed type; i.e. **GX-F6B**
- 2) Suffix I = Alternate frequency type (interference prevention) i.e. **GX-F6BI**
- 3) Without suffix = NPN type, P = PNP type; i.e. **GX-F6BI-P**
- 4) The specified rated sensing distance refers to the standard sensing object. The specified stable sensing distance is the range in which the sensor works reliably even in case of temperature or voltage deviations.
- 5) Standard sensing object = sheet steel, thickness: 1mm

Photoelectric  
Sensors

Fiber Optic  
Sensors

Standard fibers

Fiber Sensors  
Communication  
Units

Mark  
Sensors

Laser Sensors

Safety  
Sensors

Pressure & Flow  
Sensors

Inductive Proximity  
Sensors

Measurement  
Sensors

Ionizers/  
Electrostatic  
Sensors

Accessories

Index

GX-F/H

# HL-G1



**Precision laser displacement sensors**

## Features

### All-In-One Concept

All processing electronics are incorporated in a robust sensor housing. All settings can be made directly on the sensor. A 7-segment LED-display makes it easy to configure sensor operation while checking displacement values.

### Compact and lightweight body

With its lightweight plastic body, weighing just 70g and dimensions of 20.4 x 60 x 57mm, it is easy to integrate the sensor in machines and production lines where space is tight.

### User-friendly

The **HL-G1** series can be operated directly, by touch terminal (GT02/GT12 series) or Windows software via RS-422/RS-485.



## Typical applications

### Control of dispenser height

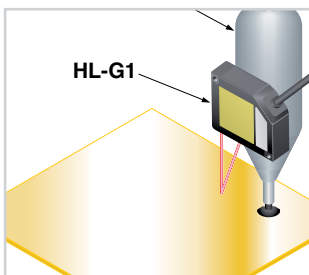

### Detection of aluminum wheel grooves

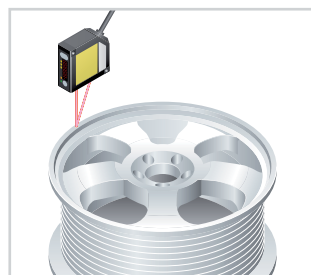

### Measuring sheet slack and thickness

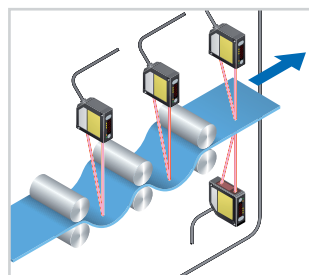

### Measuring thickness of packaging tape

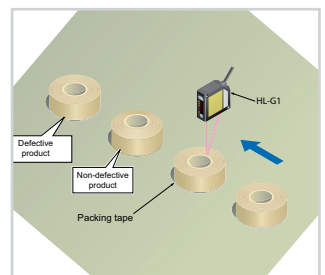

# Technical specifications

## ■ Standard type

Type	Standard type			
Model no.	HL-G103-A-C5	HL-G105-A-C5	HL-G108-A-C5	HL-G112-A-C5
Rated pressure	30±4mm	50±10mm	85±20mm	120±60mm
Emission spot size	0.1x0.1mm	0.5x1mm	0.75x1.25mm	1.0x1.5mm
Power supply voltage	24V DC ±10%			
Analog voltage output	0 to 10V / 4 to 20mA			
Response time	200µs, 500µs, 1ms, 2ms (selectable)			
Resolution	0.5µm	1.5µm	2.5µm	8µm
Linearity	±0.1 %F.S.			
Emitting element	Red laser diode, 655nm (class 2)			
Output	PNP or NPN open-collector transistor, 50mA or less (selection by wiring)			
Protection	IP67 (IEC)			
Ambient temperature	-10 bis +45°C			
Material	Enclosure: PBT / Front cover: Acrylic / Cable: PVC			
Connection method	5m cable			
Dimensions (HxWxD)	60x20.4x57mm			
Accessories	Warning label (English): 1 set			

## ■ Multifunction type

Type	Multifunction type			
Model no.	HL-G103-S-J	HL-G105-S-J	HL-G108-S-J	HL-G112-S-J
Rated pressure	30± 4mm	50±10mm	85±20mm	120±60mm
Emission spot size	0.1x0.1mm	0.5x1mm	0.75x1.25mm	1.0x1.5mm
Power supply voltage	24V DC ±10%			
Analog voltage output	0 to 10V / 4 to 20mA			
Interfaces	RS-485 / RS-422			
Response time	200µs, 500µs, 1ms, 2ms (selectable)			
Resolution	0.5µm	1.5µm	2.5µm	8µm
Linearity	± 0.1% F.S.			
Emitting element	Red laser diode, 655nm (class 2)			
Output	PNP or NPN open-collector transistor, 50mA or less (selection by wiring)			
Protection	IP67 (IEC)			
Ambient temperature	-10 to +45°C			
Material	Enclosure: PBT / Front cover: Acrylic / Cable: PVC			
Connection method	Cable with connector, 0.5m (Note)			
Dimensions (HxWxD)	60x20.4x57mm			
Accessories	Warning label (English): 1 set			

**Note:** Cable is not included in delivery. Please select under accessories (page 125).

Photoelectric Sensors

Fiber Optic Sensors

Standard Fibers

Fiber Sensor Communication Units

Mark Sensors

Laser Sensors

Safety Sensors

Pressure & Flow Sensors

Inductive Proximity Sensors

Measurement Sensors

Ionizers / Electrostatic Sensors

Accessories

Index

HL-G1

- Photoelectric Sensors
- Fiber Optic Sensors
- Standard Fibers
- Fiber Sensor Communication Units
- Mark Sensors
- Laser Sensors
- Safety Sensors
- Pressure & Flow Sensors
- Inductive Proximity Sensors
- Measurement Sensors**
- Ionizers / Electrostatic Sensors
- Accessories
- Index
- LM-10



# LM-10

The entrance model in  $\mu\text{m}$  resolution distance measurement

## Features

- High-precision measurements with comparative output

In addition to conventional analog output, the sensor is equipped with two or three standard ON/OFF control outputs (single /double comparator), allowing it to be used as a photoelectric sensor.

- Laser class 1, visible red light version

The **LM-10** series offers extraordinary performance. Automatic signal matching permits high resolution measurements over a wide dynamic range. The LM-10 series is especially suitable for accurate thickness, displacement and position measurements.

- Laser class 2, visible red light version

The LM-10 series also includes a wide range of class 2 sensor heads which offer an even higher resolution. Also a long distance type with a measuring range from 100mm to 400mm is available. The cable length of all class 2 types is expandable to up to 30m.

- LCD display for analog values and set points (double comparator type)

In addition to the analog output, the LM-10 controllers have one (single comparator type) or two (double comparator type) threshold judgement outputs. The double comparator type shows the analog values on an LCD.

## Typical applications

**Measuring packing tape thickness**

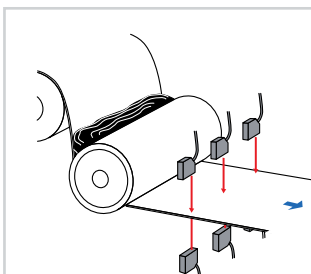

**Control amount of slack**

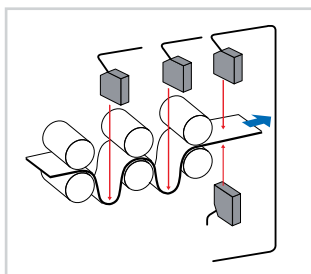

**Asymmetry detection**

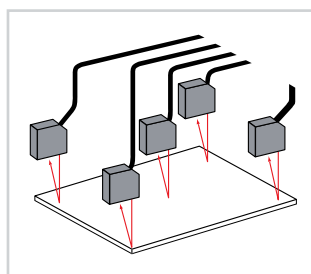

# Technical specifications

## ■ Sensor heads

Model no.	ANR1150	ANR1250	ANR1151	ANR1251	ANR1182	ANR1282	ANR1115	ANR1215	ANR1226
Laser class	1 (IEC)	2 (IEC)	1 (IEC)	2 (IEC)	1 (IEC)	2 (IEC)	1 (IEC)	2 (IEC)	2 (IEC)
Rated pressure	50±10mm				80±20mm		130± 50mm		250±150mm
Emission spot size	0.6x1.1mm		0.09x0.05mm		0.7x1.2mm		0.7x1.4mm		0.8x1.5mm
Resolution (@ 10Hz/ @ 100Hz/ @ 1kHz)	5/ 16/ 50µm	1/ 3.5/ 10µm	5/ 16/ 50µm	1/ 3.5/ 10µm	10/ 65/ 200µm	4/ 13/ 40µm	100/ 330/ 1000µm	20/ 65/ 200µm	0.15/0.5/1.5mm
Linearity	± 0.02% F.S.								± 0.4% F.S.
Emitting element	Red laser diode, 655nm								
Protection	IP67 (IEC)								
Ambient temperature	0 to +50°C								
Material	Zinc die cast								
Connection method	ANR11□: Connector attached cable, 2m; ANR12□: Connector attached cable, 0,5m (Note)								
Dimensions (Hx- WxD)	60x20x60mm								

**Note:** Connecting cable for ANR12□ is not included in delivery. Please select under accessories (page 125).

## ■ Controller

Model no.	NPN output	ANR5131	ANR5141	ANR5231	ANR5241
	PNP output	ANR5132	ANR5142	ANR5232	ANR5242
Type	Single comparator			Double comparator	
Display	LED			LCD	
Power supply voltage	12 to 24 VDC -15% / +10%				
Analog voltage output	±5V, 100mA or less	4 to 20mA		±5V, 100mA or less	4 to 20mA
Output	2x NPN or PNP transistor, 100mA or less			3x NPN or PNP transistor, 100mA or less	
Intensity output	±5V				
Alarm output	NPN or PNP open-collector transistor, 100mA or less				
Ambient temperature	0 to +50°C				
Material	Plastic				
Connection method	1.5m cable				
Dimensions (HxWxD)	35x55x96mm				

Photoelectric  
Sensors

Fiber Optic  
Sensors

Standard Fibers

Fiber Sensor  
Communication  
Units

Mark Sensors

Laser Sensors

Safety Sensors

Pressure & Flow  
Sensors

Inductive Proximity  
Sensors

Measurement  
Sensors

Ionizers/  
Electrostatic  
Sensors

Accessories

Index

LM-10

- Photoelectric Sensors
- Fiber Optic Sensors
- Standard Fibers
- Fiber Sensor Communication Units
- Mark Sensors
- Laser Sensors
- Safety Sensors
- Pressure & Flow Sensors
- Inductive Proximity Sensors
- Measurement Sensors**
- Ionizers / Electrostatic Sensors
- Accessories
- Index
- HL-C1



## HL-C1

**Ultra high-speed & stable measurement – for a variety of measurement objects**

### Features

**■ Sampling rate 10kHz**

The most amazing, ultra high-speed sampling in the industry has now been achieved for displacement sensors utilizing linear image sensors, thus enabling ultra high-speed measurement of rotating, vibrating and moving objects.

**■ Resolution of 1µm with minimal linearity error**

Available with ultra-precise 1µm resolution measurement capability and a linearity of 0.1% F.S. (for all models).

**■ Touch panel operation, easy and compact**

A variety of setting and measurement data can be displayed easily (optional).

**■ High accuracy measurement is possible, unaffected by the surface condition of the detected object**



All deficiencies inherent in the conventional PSD sensing method have now been completely solved. Whereas the PSD method measures position information from the center of gravity of the total light quantity distribution of the light spots connected along each light element, the linear image sensing method measures the peak position values for the light spots themselves. This advance now makes high-precision measurement possible, regardless of the surface condition of the object, whether for metal hairline surface cracks or for non-reflective surfaces, e.g. black rubber.

**■ Two sensor heads can be connected! Reduces costs and saves space**

**■ Controller compact and front connection reduces setup space**

The ultra compact controller with dimensions of W40×H120×D74mm requires extremely little space for installation. Installation to a DIN rail is also possible. Furthermore, all cables can be connected at the front of the controller in order to save further space.

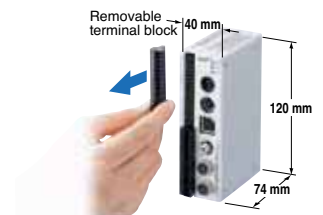

**■ Equipped with a serial output/input**

An RS-232C interface for serial input and output is provided so that settings can be retrieved and saved.

**■ Special version for measurement of raw and completed rubber tire**

The **HL-C1** series has added a new line of tire measuring specialized versions for tire making processes. The 5mW type enables high accuracy and stable measurement of raw tires and completed tires which were previously considered difficult to measure.

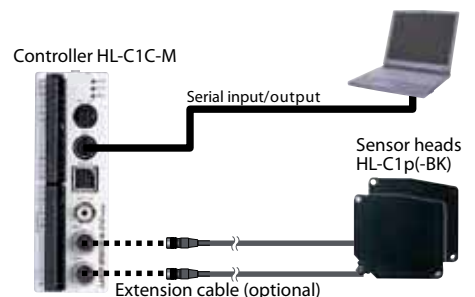



# Typical applications

## Measuring glass substrate thickness

The HL-C1 series specular reflective type realizes stable distance measurements even for specular and transparent objects.



## Detecting the presence of a resin coating

The HL-C1 series specular reflective type realizes stable distance measurement even for specular and transparent objects.

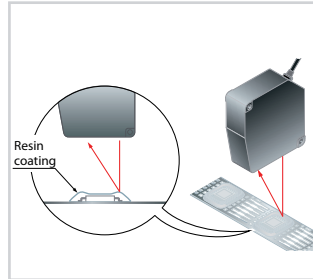

## Measuring the eccentricity of a metal shaft

The HL-C1 series detects translucent resin coating.



# Technical specifications

## ■ Sensor heads

Type	Diffuse reflective			Specular reflective		
	Model no.	HLC135CBK10	HL-C108BBK	HL-C105BBK	HL-C108B	HL-C105B
Rated pressure		350±200mm	85±20mm	50±5mm	81.4±16mm	46±4mm
Emission spot size		400x200µm	100x140µm	70x120µm	100x140µm	70x120µm
Resolution		10µm	2µm	1µm	2µm	1µm
Linearity	± 0.02% F.S.					
Emitting element		Red laser diode, 658nm (class 3B)	Red laser diode, 658nm (class 2)			
Protection	IP67 (IEC)					
Ambient temperature	0 to +45°C					
Material	Enclosure: Die-cast aluminum / Front cover: glass					
Connection method	Cable with connector, 0.5m					
Dimensions (HxWxD)	82x87x26.6mm					
Accessories	Warning label (English): 1 set					

## ■ Controller

Type	Standard	Long sensing range
Model no.	HL-C1-M	HL-C1-M-WL
Applicable sensor heads	HL-C108B(BK), HL-C105B(BK)	HL-C135C-BK10
Power supply voltage	24VDC ±10%	
Sampling rate	Selectable: 100µs, 144µs, 200µs, 255µs, 332µs, 498µs, 1000µs	
Output	PhotoMOS relay	
Analog voltage output	Output voltage	±5V/F.S. (Note)
	Output current	4 to 20mA
Protection	IP67 (IEC)	
Ambient temperature	0 to +50°C	
Dimensions (HxWxD)	120x40x74mm	120x60x74mm
Connection method	Connector (sensors), terminal block	
Accessories	-	Keys, 2 pcs.

Note: At factory setting.

# HL-C2

Ultra high-speed, precision laser displacement sensors



## Features

- Excellent basic performance

- Sampling rate 100kHz

The HDLC-CMOS sensors were developed especially for the **HL-C2** series. The high-resolution chip together with a very short processing time enables maximum resolution and speed.

- Resolution up to  $0.01\mu\text{m}$ , linearity up to  $\pm 0.02\% \text{F.S.}$

Superior resolution of  $0.01\mu\text{m}$ . Linearity of  $\pm 0.02\% \text{F.S.}$  enabled by latest high resolution lens technology.

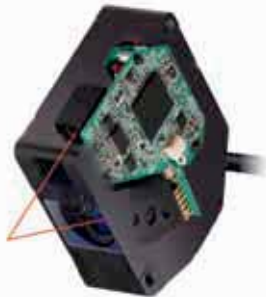

- Touch panel simplifies operation

Measurement values and light intensity are displayed. Via the menu, you can set the sensor head function and output conditions.



- Compact sensor head saves space

The volume ratio has been reduced by 23% compared to the previous model, minimizing installation space.

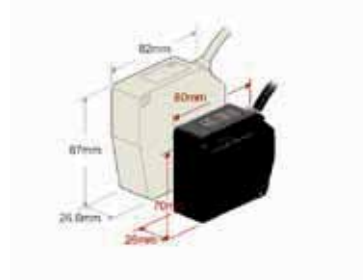

- Compact but with a wide array of functions

You can connect two sensor heads and a variety of devices to the ultra compact controller. Measurement values can be analyzed and displayed while the sensors are being controlled.



# Typical applications

Measurement of the position of patterned glass

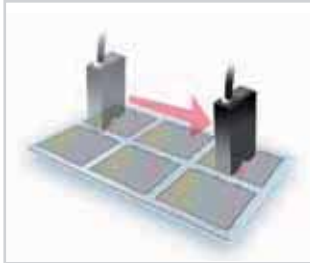

Control of the camera focus



Measurement of the shape of a camshaft



Measurement of the heights of chip parts



## Technical specifications

### Sensor heads

Type	Specular reflective	Diffuse reflective		
	HL-C201F(-E)(-MK) (Note)	HL-C203F(-E)(-MK)	HL-C211F(-E)(-MK)	HL-C211F5(-E)(-MK)
Rated pressure	10±1mm	30±5mm	110±15mm	110±15mm
Emission spot size	Ø20µm, -MK: 20x700µm	Ø30µm, -MK: 30x1200µm	Ø80µm, -MK: 80x1700µm	
Linearity	± 0.02% F.S.	± 0.03% F.S.		
Emitting element	Red laser diode, 658nm			
Laser class	1 (IEC)	2 (IEC)		3R (IEC)
Protection	IP67 (IEC)			
Ambient temperature	0 to +45°C			
Material	Enclosure: Die-cast aluminum / Front cover: glass			
Connection method	Cable, 0.5m with attached connector			
Dimensions (HxWxD)	54x20x95mm	80x26x70mm	95x26x74mm	
Accessories	Warning label (English): 1 set			

Notes:  
 Suffix -E = Reduced resolution types.  
 Suffix -MK = Line spot type.

### Controller

Type	NPN	PNP
Model no.	HL-C2C	HL-C2C-P
Power supply voltage	24VDC ±10%	
Analog voltage output	±5V/F.S., 4-20mA F.S.	
Output	NPN or PNP open-collector transistor, 100mA or less	
Inputs	Timer, zero set, remote interlock, reset	
USB interface	USB 2.0	
Serial input/output	RS232C (9.6-115.2kbit/s)	
Current consumption	With 1 sensor head: 350mA With 2 sensor heads: 500mA	
Ambient temperature	0 to +50°C	
Material	Polycarbonate	
Connection method	Connector (sensors), terminal block	
Dimensions (HxWxD)	130x59x105.5mm	

Photoelectric Sensors

Fiber Optic Sensors

Standard Fibers

Fiber Sensor Communication Units

Mark Sensors

Laser Sensors

Safety Sensors

Pressure & Flow Sensors

Inductive Proximity Sensors

Measurement Sensors

Ionizers / Electrostatic Sensors

Accessories

Index

HL-C2

- Photoelectric Sensors
- Fiber Optic Sensors
- Standard Fibers
- Fiber Sensor Communication Units
- Mark Sensors
- Laser Sensors
- Safety Sensors
- Pressure & Flow Sensors
- Inductive Proximity Sensors
- Measurement Sensors**
- Ionizers / Electrostatic Sensors
- Accessories
- Index
- HL-T1**



# HL-T1

**A high-functionality intelligent controller**

## Features

- **Small sensor head**

The most compact size and yet the highest level of performance in their class. These sensors save space.

- **Resolution of 4 $\mu$ m**

A high resolution of 4 $\mu$ m (at an average 64 sampling cycles) allows high-precision positioning and size judgment.

- **High-precision measurement even of minute differences in light intensity**

The sensors are sensitive to minute differences in light intensity so that they can judge even the opacity of glass and turbidity of liquids. In addition, the amount of light received can be displayed as a percentage to allow you to determine permeation rates.

- **Calculations for 2 sensors are possible**

The calculation unit (optional) just needs to be connected between the two controllers to enable calculations (addition and subtraction) to be carried out for two sensors. No digital panel controller is needed.



Sheet width measurement

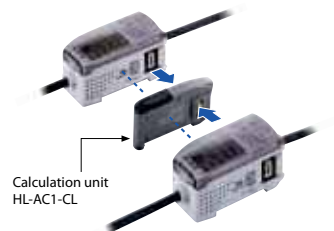

Calculation unit HL-AC1-CL

- **FDA standards conforming types are available**

FDA standards conforming types, most suitable for equipment used in the USA, are now available (FDA: class II, IEC/JIS: class 1).

## Typical applications

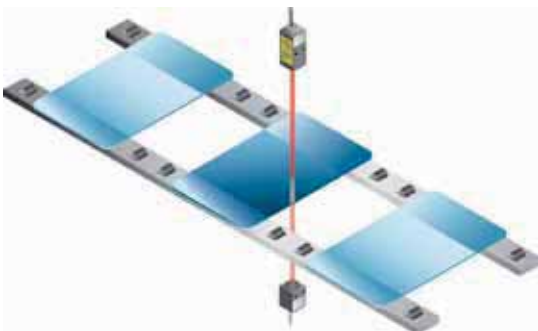

Distinguishing opacity of glass

# Technical specifications

## Sensor heads

Type	Beam diameter $\phi$ 1mm		Sensing width 5mm	Sensing width 10mm
Model no.	HL-T1001A(F) (Note 1)		HL-T1005A(F)	HL-T1010A(F)
Sensing width/Diameter	$\phi$ 1mm	$\phi$ 1 to 2.5mm	5mm	10mm
Rated pressure	0 to 500mm	500 to 2,000mm	500mm	
Minimum sensing object	$\phi$ 8 $\mu$ m opaque object	$\phi$ 50 $\mu$ m opaque object	$\phi$ 0.05mm opaque object	$\phi$ 0.1mm opaque object
Repeatability (during the state in which light is half blocked)	4 $\mu$ m	–	4 $\mu$ m	
Linear output resolution	4 $\mu$ m	–	4 $\mu$ m	
Ambient temperature	0 to +50°C			
Emitting element	Infrared semiconductor laser, Class 1 (IEC/JIS)			

### Notes:

- 1) HL-T10A is a IEC/JIS standards conforming type.  
HL-T10F is a FDA standards conforming type..

## Controller

Type	NPN	PNP
Model no.	HL-AC1	HL-AC1P
Power supply voltage	12 to 24VDC $\pm$ 10%	
Measuring cycle	150 $\mu$ s	
Analog voltage output	Current / voltage output switchable Current output: 4 to 20mA/F.S., max. load resistance 300 $\Omega$ Voltage output: $\pm$ 5V, Output impedance 100 $\Omega$	
Temperature characteristics	$\pm$ 0.2% F.S. °C	
Output	3 x NPN or PNP open-collector transistors, 50mA or less	
Ambient temperature	0 to +50°C	
Dimensions (HxWxD)	34.3x30x64.3mm	

Photoelectric Sensors

Fiber Optic Sensors

Standard Fibers

Fiber Sensor Communication Units

Mark Sensors

Laser Sensors

Safety Sensors

Pressure & Flow Sensors

Inductive Proximity Sensors

Measurement Sensors

Ionizers / Electrostatic Sensors

Accessories

Index

HL-T1

- Photoelectric Sensors
- Fiber Optic Sensors
- Standard Fibers
- Fiber Sensor Communication Units
- Mark Sensors
- Laser Sensors
- Safety Sensors
- Pressure & Flow Sensors
- Inductive Proximity Sensors
- Measurement Sensors**
- Ionizers / Electrostatic Sensors
- Accessories
- Index
- GP-X**



# GP-X

**Eddy current analog sensor for high-speed sampling**

## Features

- Ultra high-speed response time of 25 $\mu$ s
- Extremely low temperature deviations (0,07% F.S.°C)
- Predefined material characteristics

The sensor exhibits  $\pm 0.3$  % F.S. linearity deviation when used on iron and stainless steel. Furthermore, characteristics for other materials are already programmed in the controller, making selection easy. Of course, the settings can also be customized.

### ■ Serial interface

The controller can be connected with a personal computer via an RS-232 interface. GP-XAiME, the software included, simplifies data visualization and analysis. Moreover, several systems can be combined and then easily configured at the same time.

- The 5-digit, dual, 2-color digital display offers great visibility

If the measurement results fall within the setting range (GO), they will appear on the lower digital display in green. If they are out of setting range (HI, LO), they will be displayed in the upper digital display in orange. The display position and color change permit accurate visibility even for momentary changes.

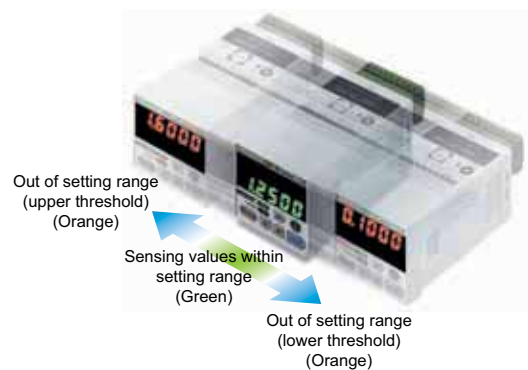

## Typical applications

### Stroke end sensing

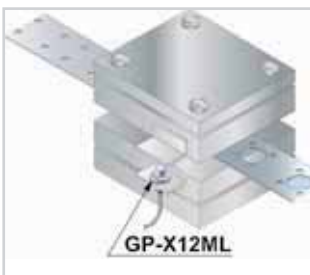

### Eccentricity sensing



### Height sensing



# Technical specifications

Type		Cylindrical heads			Heads with thread		
Model no.	NPN output	GP-XC3SE (Note 2)	GP-XC5SE	GP-XC8S	GP-XC10M	GP-XC12ML	GP-XC22KL
	PNP output	GP-XC3SEP	GP-XC5SEP	GP-XC8SP	GP-XC10MP	GP-XC12MLP	GP-XC22KLP
Rated pressure		0 to 0.8mm	0 to 1mm	0 to 2mm	0 to 2mm	0 to 5mm	0 to 10mm
Standard sensing object		Stainless steel (SUS304) / Iron sheet, cold rolled carbon steel (SPCC) 60x60x1 mm					
Power supply voltage		24V DC $\pm 10\%$					
Analog voltage output		-5V to +5V (Note 1)					
Sampling rate		40kHz (25 $\mu$ s)					
Resolution		GP-XC3SE / GP-XC5SE: 0.04% F.S. (64 times average processing) GP-XC8S / GP-XC10M / GP-XC12ML / GP-XC22KL: 0.03% F.S. (64 times average processing)					
Output		3x NPN or PNP open-collector transistor, 100mA or less					
Protection		Sensor head: IP67 (IEC)					
Ambient temperature		Sensor head: -10 to +55°C, Controller: 0 to +50°C					
Material		Sensor head: stainless steel (SUS303), GP-XC12ML□, GP-XC22KL□: brass (nickel plated), Switch part: PC					
Connection method		Terminal block					
Dimensions	Sensor head (ØxD)	3.8x17mm	5.4x17mm	8x17mm	M10x17mm	M12x21mm	M12x35mm
	Controller (HxWxD)	48x48x83mm					
Accessories		Controller mounting frame, 1 pc.					

## Notes:

- 1) Factory setting: 0 to +5V
- 2) Model no. for one set (sensor head and controller)

Photoelectric  
Sensors

Fiber Optic  
Sensors

Standard Fibers

Fiber Sensor  
Communication  
Units

Mark Sensors

Laser Sensors

Safety Sensors

Pressure & Flow  
Sensors

Inductive Proximity  
Sensors

Measurement  
Sensors

Ionizers /  
Electrostatic  
Sensors

Accessories

Index

GP-X

## ER-Q

### Miniature ionizer with fan



## Features

### ■ Small dimensions

Simple and space-saving installation on production lines and manual workstations.

### ■ Adjustable

A continuously variable adjuster ensures the production of the required air volume.

### ■ Unit for demanding industrial environments

The LED displays the required maintenance steps or failures; this also can be queried via the outputs of a PLC. Parts for maintenance are easy to get at and replace.



## Technical specifications

Type	Standard type
Model no.	ER-Q
Charge removal time (+-1000 > +-100V)	Approx. 1.5s
Discharge output voltage	± 2kV
Ion balance	Max. ± 10V
Discharge method	High frequency AC method
Power supply voltage	24V DC ±10%
Power consumption	200mA or less
Fan rotation speed	Continuously variable adjustable (potentiometer)
Outputs	ERROR and CHECK NPN open-collector transistor, max. 50mA
Status indicator / Monitoring function	Ready/Discharging (DSC/green), Discharge error (red), Fan error (blinking red)
Ambient temperature	0 to +50°C
Ambient humidity	35 to 65%RH
Material	Enclosure: PBT, Discharge needles: tungsten
Dimensions (HxWxD)	60x33x65mm
Accessories	I/O connector set manufactured by MOLEX, Inc.: Housing 5557-08P, terminal 5556T



# ER-F



## Fan type ionizer

### Features

#### ■ Two types

Low volume fan type. This type generates only the half of the air volume as the standard type, which is required for small components and thin film. Four different speeds can be selected for the fan.

#### Standard fan type ER-F12

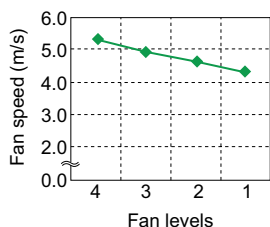

#### Low-volume fan type ER-F12S

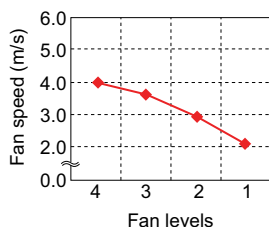

#### ■ Easy maintenance

Because the discharge needle unit is attached to the louver, exchange or maintenance of the needles is made easy without touching the main unit.

A safe design: once the louver is removed, the high-voltage circuit is broken and the fan halts.

Simply replace the louver to change configuration between long distance and wide area ionization.

The two louvers come with the ionizer main body.

#### Straight louver removes charges at great distances



Neutralizes static charges quickly from a great distance

#### Angled louver removes charges over wide area



Neutralizes static charges; wide area ionizer

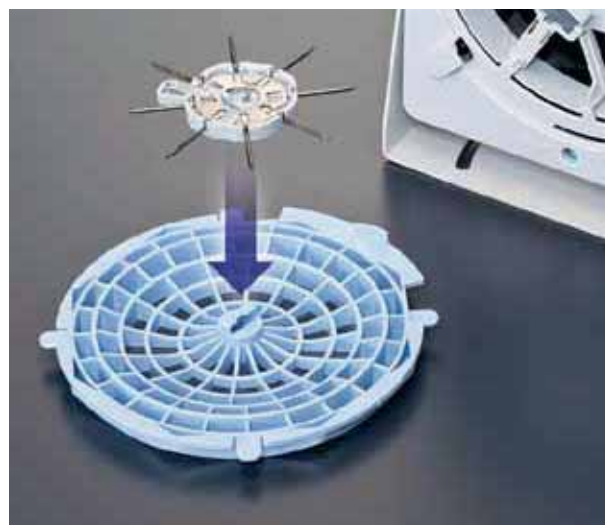

Photoelectric Sensors

Fiber Optic Sensors

Standard fibers

Fiber Sensors Communication Units

Mark Sensors

Laser Sensors

Safety Sensors

Pressure & Flow Sensors

Inductive Proximity Sensors

Measurement Sensors

Ionizers / Electrostatic Sensors

Accessories

Index

ER-F

## Technical specifications

Type	Standard type	Low-volume fan type
<b>Model no.</b>	<b>ER-F12</b>	<b>ER-F12S</b>
<b>Discharge time (+-1000 &gt; +-100V)</b>	Approx. 1s	Approx. 1.5s
<b>Discharge output voltage</b>	±2kV	
<b>Ion balance</b>	±10V or less	
<b>Discharge method</b>	High-frequency AC	
<b>Power supply voltage</b>	24VDC ±10%	
<b>Power consumption</b>	700mA or less	400mA or less
<b>Fan rotation speed</b>	Adjustable at 4 levels	
<b>Output</b>	ERROR, NPN open-collector transistor, 50mA or less	
<b>Input terminal</b>	Discharge stop = connected to 0V / Start= open	
<b>Status indicators / Monitoring functions</b>	Power supply voltage (Power / green), Discharging (DSC / green), Discharge error (DSC red), Fan error (FAN red)	
<b>Ambient temperature</b>	0 to +50°C	
<b>Ambient humidity</b>	35 to 65%RH	
<b>Material</b>	Enclosure / Louver: ABS, Fitting of discharge needles: PBT, Discharge needles: tungsten, Mounting bracket: DC03	
<b>Dimensions (HxWxD)</b>	166x161x60mm	
<b>Accessories</b>	Straight louver (Note 1): 1 pc. Angle louver: 1 pc.; Caution label: 1 set; Rubber cushion: 1 pc.	

**Note:** The discharge needle set is mounted at the louver.

ER-F

# ER-X



## Area ionizer for fast applications

## Features

### ■ Quick charge removal

Thanks to the pulse AC method, the **ER-X series** is well suited for high-speed applications as found in the packaging and semiconductor industries, where charge removal time is directly linked to productivity. In addition, discharge frequencies can be adjusted from between 1 and 100Hz, maximizing flexibility. Thanks to a built-in feedback system, the ionizer can even adjust the discharge frequency automatically during operation.

### ■ Feedback system

Individual displays for discharge, error messages and needle control are provided on the controller. Furthermore, you can activate settings for frequency, ion balance or limits directly via a potentiometer and DIP switches.



### ■ Airless operation

The area ionizer of the ER-X series ionizers can be operated with or without air pressure. This technology opens up applications in fields such as the coating industry, as well as the production and packaging of microelectronic components that otherwise are blown around by whirling air.

### ■ Flexible system configuration

The system consists of a sensor head and a controller. The sensor head is available in different sizes. You can connect parallel up to 2 heads to the controller. This enlarges the working area of the system up to 1.2m.



## Typical applications

### Neutralization of foils



### Charge removal from ICs



### Charge removal from miniaturized electronic components



Photoelectric Sensors

Fiber Optic Sensors

Standard fibers

Fiber Sensors Communication Units

Mark Sensors

Laser Sensors

Safety Sensors

Pressure & Flow Sensors

Inductive Proximity Sensors

Measurement Sensors

**Ionizers / Electrostatic Sensors**

Accessories

Index

ER-X

# Technical specifications

## ■ Sensor heads

Model no.	ER-X016	ER-X032	ER-X048	ER-X064
<b>Effective charge removal width</b>	160mm	320mm	480mm	640mm
<b>Charge removal time (+-1000 &gt; +-100V)</b>	Approx. 1s			
<b>Discharge output voltage</b>	± 7kV			
<b>Ion balance</b>	Max. ± 30V			
<b>Discharge method</b>	Pulse AC method			
<b>Maximum air pressure</b>	5bar (0.5MPa)			
<b>Ambient temperature</b>	0 to +50°C			
<b>Ambient humidity</b>	35 to 65%RH			
<b>Material</b>	Enclosure: PPS, Stainless steel; Mounting bracket, Stainless steel; Needle: tungsten			

## ■ Controller

Model no.	ER-XC02
<b>Power supply</b>	24V DC ±10%
<b>Power consumption</b>	1 head: max. 450mA; 2 heads: 800mA or less
<b>Outputs</b>	Alarm, Error; PhotoMOS, 50mA or less
<b>Status display / Monitor functions of discharge unit</b>	Discharge (DSC)
<b>Ambient temperature</b>	0 to +50°C
<b>Ambient humidity</b>	35 to 65%RH
<b>Material</b>	ABS
<b>Dimensions (HxWxD)</b>	90x53x64mm
<b>Accessories</b>	Molex-plug (Housing 5557-10R, Terminal 5556TL) 1 pc., Ground wire 1pc.

# ER-TF

## Wide-area ionizer



## Features

### ■ High function volume

Wide-area ionizer **ER-TF** effectively neutralizes electrostatic charge between different stages of production. The series is designed for stable operation and easy maintenance. The device is available in different lengths. Moreover, there is no need for compressed air, which makes installation easy and keeps costs under control.

### ■ Air flow can be set to 4 different speeds

The MAX setting quickly removes static charge over a wide area.



### ■ Flexible layout

The direction of the air output can be adjusted after mounting.

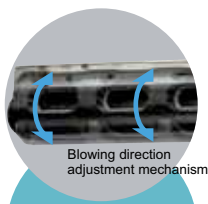

### ■ Safe design

Detection of entry to the discharger interrupts the high voltage circuit.

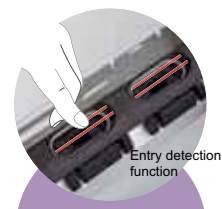

### ■ Easy maintenance

Discharge needle units can be removed and attached quickly.

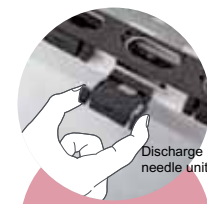

The fan air intake filter can be easily removed. This greatly reduces the time needed for cleaning.



Photoelectric Sensors

Fiber Optic Sensors

Standard fibers

Fiber Sensors Communication Units

Mark Sensors

Laser Sensors

Safety Sensors

Pressure & Flow Sensors

Inductive Proximity Sensors

Measurement Sensors

Ionizers / Electrostatic Sensors

Accessories

Index

ER-TF

## Characteristics of ER-TF series

The layout of this ionizer allows it to be installed in a number of ways not possible for common, commercially available ionizers.

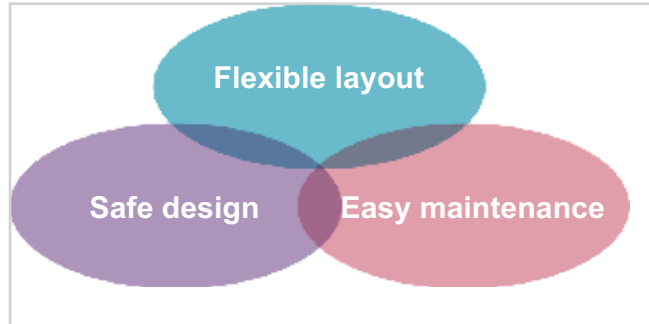

## Typical applications

**Desktop setup, 800mm type to accommodate wide workstation**

**400mm type for electrostatic discharge at a single workstation**

**Overhead setup to cover cell production**

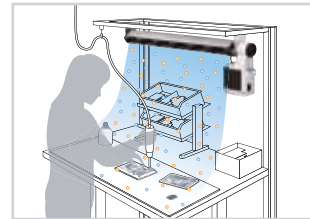
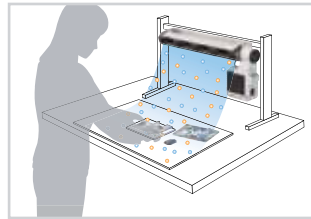
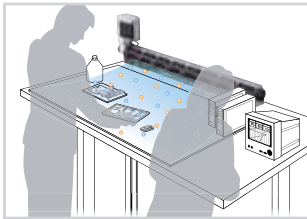

## Technical specifications

Type	Area type		
Model no.	ER-TF04-EX	ER-TF06-EX	ER-TF08-EX
Charge removal time (+-1000 > +-100V)	Approx. 1s		
Discharge output voltage	±6kV		
Ion balance	max. ± 10V		
Discharge method	DC		
Power supply unit	Input voltage: 100 to 240 VAC, output voltage: 24V DC ±10%		
Power consumption	80VA or less		
Fan rotation speed	Adjustable at 4 levels		
Output	ERROR, NPN open-collector transistor, 50mA or less		
Status display / Monitor functions of discharge unit	Supply voltage (Power / green), Discharge or fan error (Error / red), Maintenance (Check / orange)		
Status display on fan	Discharge unit error or maintenance (BAR / yellow), Fan error or maintenance (FAN / yellow)		
Ambient temperature	0 to +50°C, power supply unit 0 to 40°C		
Ambient humidity	35 to 65% RH		
Material	Housing discharge unit / Fan: ABS, Discharge needles: tungsten, Mounting bracket: DD11		
Discharge unit dimensions (HxWxD)	65x414x60mm	65x574x60mm	65x734x60mm
Dimensions (HxWxD)	123x100x44mm		
Accessories	Power supply unit, Ground wire, Filter 5 pcs., Caution labels 2 pcs.		

# ER-VW

- Photoelectric Sensors
- Fiber Optic Sensors
- Standard fibers
- Fiber Sensors Communication Units
- Mark Sensors
- Laser Sensors
- Safety Sensors
- Pressure & Flow Sensors
- Inductive Proximity Sensors
- Measurement Sensors
- Ionizers / Electrostatic Sensors
- Accessories
- Index



## Nozzle angle adjustment

### Features

#### ■ Nozzle angle adjustment

The angles of the two nozzles can be adjusted within a range of approximately 190° by screwing down the ends of the nozzles.

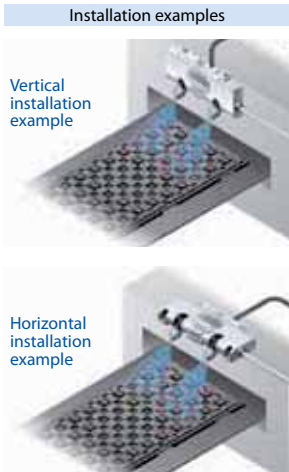

#### ■ Compact and ultrathin design

The thickness of the unit is 18.9mm. Since the nozzle angles can be adjusted, they can be installed in tight spaces, such as when other equipment is present.

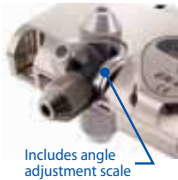

#### ■ Minimum air consumption 15ℓ/min.

The **ER-VW** series can utilize air flow levels starting from a minimum of 15 l/min. Because the amount of air consumed is so low, the loads placed on air supply equipment can be reduced.

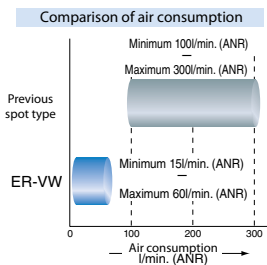

#### ■ Air supply monitoring function

This function causes discharging to stop automatically if the supply of air drops below a certain pressure. Notification of this is given when the AIR indicator lights up and the discharge output (DSC) turns off. This prevents objects which are not charged from being overlooked when the air supply has been stopped.

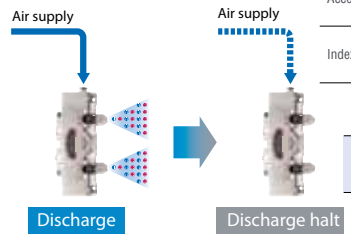

#### ■ Easy connection possible

The joint kit (optional) can be used to connect up to a maximum of 5 ER-VW units. The air supply part is connected via quick connection joints, and the power supply and input/output signals can also be connected easily using connection cables with connectors at both ends.

Multiple ER-VW units can be connected to provide charge removal layouts that suit the target equipment.

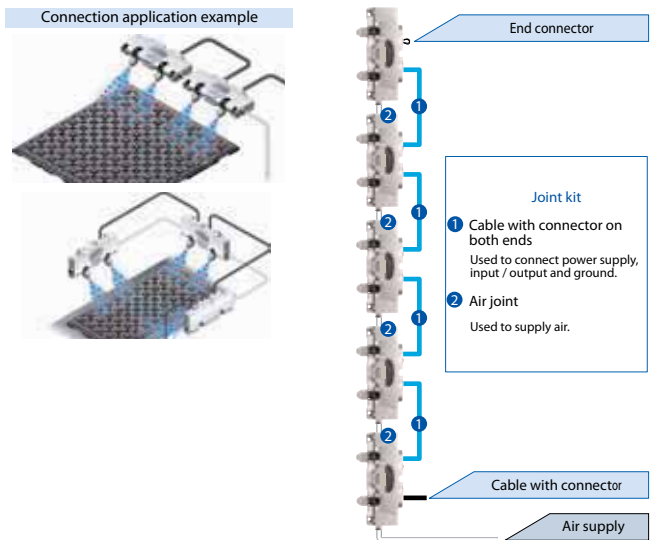

# Ionizers / Electrostatic Sensors

## ■ Functions to support accurate charge removal

In addition to the air supply monitoring function, the ER-VW is equipped with the following functions to ensure accurate charge removal.

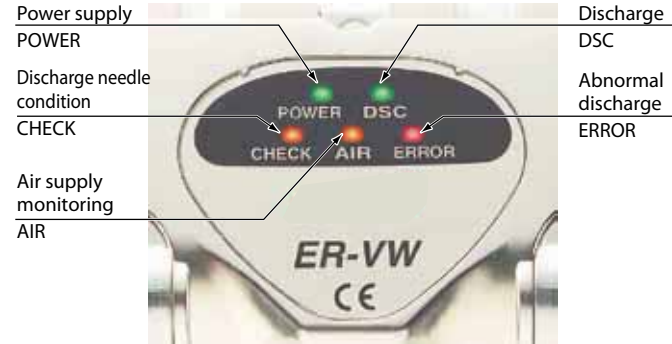

## Typical applications

Charge removal of ICs

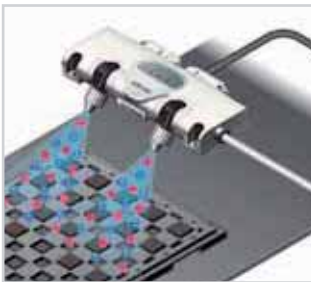

Removing charge during pickup from dicing type

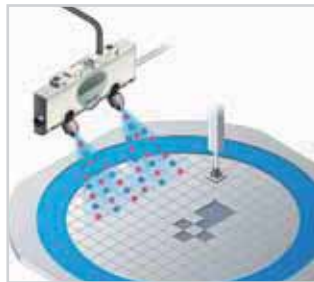

Parallel discharging on two assembly lines

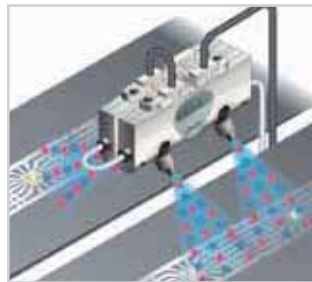

Removing charges from LCD transport brackets

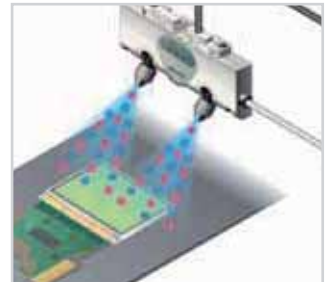

## Technical specifications

Type	Spot type
Model no.	ER-VW
Charge removal time (+-1000 > +-100V)	1s or less
Discharge output voltage	± 2kV
Ion balance	±10V or less
Discharge method	High frequency AC method
Power supply voltage	24V DC ±10%
Power consumption	120mA or less
Air pressure	0.5 to 5bar (0.05 to 0.50MPa)
Inputs	Reset and discharge stop = connected to 0V / Start= open
Outputs	Discharging (DSC), ERROR and CHECK; NPN open collector transistor; 50mA or less
Status indicators / Monitoring functions	Supply voltage (Power / green), Discharging (DSC / green), Checking needles (Check / orange), Monitoring air pressure (Air / orange), Failure (Error / red)
Ambient temperature	0 to +55°C
Ambient humidity	35 to 65%RH
Material	Enclosure: ABS (nickel plated), nozzles / nozzle mount, Screws: stainless steel, Discharge needles: tungsten
Dimensions (HxWxD)	19x133x65mm
Accessories	Connector cable with 8 pins, 0.5m, Terminating plug with 9 pins, Ground wire



# ER-V



## Ultra compact high-performance ionizer

### Features

#### ■ Produces excellent ion balance

The adoption of high-frequency AC method allows extremely stable ion balance to be achieved. Because the ion balance is not affected by the pressure of air supplied or by the setup distance, no troublesome adjustments are required after setup.

#### ■ High performance but no controller needed

A full range of functions have been provided with full consideration given to ease of use in the workplace. No separate controller is needed.

#### ■ Nozzle variations can be selected to suit the application



#### ■ Ultra compact design accurately removes charges of objects even from narrow spaces

The main unit is merely 28x30x110mm so it can easily be combined with other devices and also be installed as an add-on. Furthermore, the high-voltage power supply is built-in so no extra space is required except for the ionizer itself.

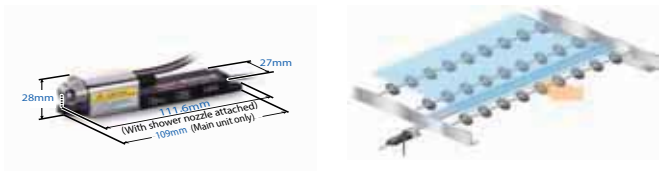

It can be installed in places where the conventional bar type cannot so it can be placed closer to the object for more accurate charge removal.

### Typical applications

#### Change removal and dust removal of lenses



#### Prevent discharge damage in circuit board LEDs



#### Charge removal glass surfaces

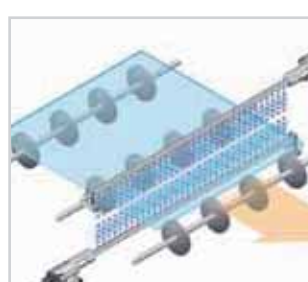

Photoelectric Sensors

Fiber Optic Sensors

Standard fibers

Fiber Sensors Communication Units

Mark Sensors

Laser Sensors

Safety Sensors

Pressure & Flow Sensors

Inductive Proximity Sensors

Measurement Sensors

Ionizers / Electrostatic Sensors

Accessories

Index

ER-V

## Technical specifications

Photoelectric Sensors
Fiber Optic Sensors
Standard fibers
Fiber Sensors Communication Units
Mark Sensors
Laser Sensors
Safety Sensors
Pressure & Flow Sensors
Inductive Proximity Sensors
Measurement Sensors
<b>Ionizers / Electrostatic Sensors</b>
Accessories
Index
ER-V

Type	Spot type
<b>Model no.</b>	<b>ER-VS01</b>
<b>Charge removal time (+-1000 &gt; +-100V)</b>	1s or less
<b>Discharge output voltage</b>	±2kV
<b>Ion balance</b>	±10V or less
<b>Discharge method</b>	High frequency AC method
<b>Power supply voltage</b>	24VDC ±10%
<b>Power consumption</b>	70mA or less
<b>Maximum air pressure</b>	0.5 to 7bar (0,05 to 0.7MPa)
<b>Inputs</b>	Reset and discharge stop = connected to 0V / Start= open
<b>Outputs</b>	Error (ERROR) and check (CHECK) NPN open-collector transistor, 50mA or less
<b>Status indicators / Monitoring functions</b>	Supply voltage (Power / green), Discharging (DSC / green), Checking needles (Check / orange), Error (Error / red)
<b>Ambient temperature</b>	0 to +55°C
<b>Ambient humidity</b>	35 to 65%RH
<b>Material</b>	Enclosure: PPS, Cover: stainless steel, Discharge needles: tungsten
<b>Dimensions (HxWxD)</b>	28x30x110mm
<b>Accessories</b>	I/O connector set manufactured by MOLEX, Inc.: Housing 5557-08P, terminal 5556TL

# EC-G



## Pulse air-gun ionizer

Photoelectric Sensors

Fiber Optic Sensors

Standard fibers

Fiber Sensors Communication Units

Mark Sensors

Laser Sensors

Safety Sensors

Pressure & Flow Sensors

Inductive Proximity Sensors

Measurement Sensors

Ionizers / Electrostatic Sensors

Accessories

Index

EC-G

## Features

### ■ Direct ionized air emission from air gun

With the new pulse air-gun ionizer operators can comfortably neutralize static electricity while manually cleaning.

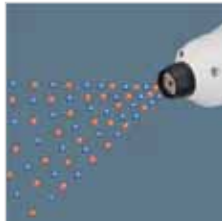

### ■ Pulsed ionized air

Instant pulse air emission with high air pressure removes dust all at once. Its lightweight construction, ergonomic design and 2m cable make the air gun the perfect ionizer for manual jobs.



### ■ White LED illumination

A convenient white LED on the front of the gun illuminates target objects.



## Technical specifications

Type	Air gun type
Model no.	EC-G01
Charge removal time (+-1000 > +-100V)	Average 0.5s
Discharge output voltage	±1kV
Ion balance	±10V or less
Discharge method	High frequency AC method
Power supply unit	Input voltage: 100 to 240VAC, output voltage: 24V DC ±10%
Power consumption	30VA or less
Maximum air pressure	0.5 to 5bar (0.05 to 0.50MPa)
Input terminal	Charge removal start = connected to 0V
Modes	Pulse 1 (long) and Pulse 2 (short) / CONT (continuous) selectable by switch
LED illumination mode	White LED
Status indicator / Monitoring function	Valve illumination (orange)
Ambient temperature	0 to +50°C
Ambient humidity	35 to 65% RH (no condensation allowed)
Material	Enclosure: ABS, Nozzle: Stainless steel, Nozzle guard: NBR, Discharge needle: tungsten
Weight	approx. 270g
Accessories	AC adapter, 1 pc.; Exclusive intermediate cable, 2m; Straight joints to couple air tubes ø 8-8mm (Note) and ø 8-6mm type, Connector connection terminal from MOLEX

Note: Straight joint to couple air tubes, ø 8mm, is attached at shipment.

## Typical applications

### Remove charge and dust on PCB



### Remove charge and dust on flat screens



### Remove dust before painting



# EF-S1

Constant monitoring of static charges on production lines



## Features

- Maintains and regulates product quality by preventing damage from static electric

Static electricity that can build up in various places along a process line can be monitored constantly so that abnormalities can be prevented before they occur, ensuring quality.

- Reduces time for ionizer inspections

The de-ionizing effectiveness of ionizers can be understood in real-time so that things such as ionizer damage and the replacement period for worn components can be checked objectively, reducing the time required for inspection and testing.

## Technical specifications

- Sensor head

Type	Spot type
Model no.	EF-S1HS
Measuring range	8.0 to 20.5mm ( $\pm 1$ kV) 21.0 to 100mm ( $\pm 2$ kV)

- Controller

Type	Spot type
Model no.	EF-S1C
Power supply voltage	24VDC $\pm 10\%$
Display range (Measurement range)	-1000 to 1000 ( $\pm 1$ kV) -1999 to 1999 ( $\pm 2$ kV)
Judgment output	NPN open-collector transistor, 100mA or less
Analog voltage output	Output voltage 1 to 5V Output impedance approx. 100 $\Omega$

## Typical applications

Measuring surface potential when removing BG sheets









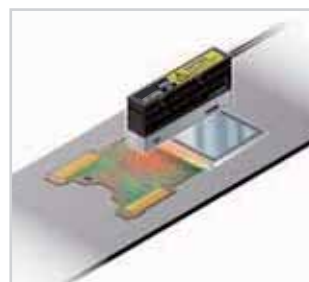









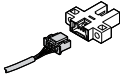
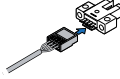
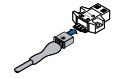

Measuring static electric charge in lead frames



Measuring frictional electrification of LCD modules



## Cables

Picture	Description	Model no.	Applicable sensors
	4-pin M8 connector cable, 2m	<b>UZZ80820D</b>	CX-4□Z, FX101□Z, FX102□Z, DP11□EPJ
	4-pin M8 connector cable (elbow type 90°), 2m	<b>UZZ80821D</b>	CX-4□Z, FX101□Z, FX102□Z, DP11□EPJ
	4-pin M8 connector cable, 5m	<b>UZZ80850D</b>	CX-4□Z, FX101□Z, FX102□Z, DP11□EPJ
	4-pin M8 connector cable (elbow type 90°), 5m	<b>UZZ80851D</b>	CX-4□Z, FX101PZ, FX102□Z, DP11□EPJ
	4-pin M12 connector cable, 2m	<b>UZZ81220D</b>	LX-101□Z, CX-4□Z, EQ-30, CY-1□Z, GX-M□-Z
	4-pin M12 connector cable (elbow type 90°), 2m	<b>UZZ81221D</b>	LX-101□Z, CX-4□Z, EQ-30, CY-1□Z, GX-M□-Z
	4-pin M12 connector cable, 5m	<b>UZZ81250D</b>	LX-101□Z, CX-4□Z, EQ-30, CY-1□Z, GX-M□-Z
	4-pin M12 connector cable (elbow type 90°), 5m	<b>UZZ81251D</b>	LX-101□Z, CX-4□Z, EQ-30, CY-1□Z, GX-M□-Z
	4-wire cable with connector, 2m	<b>CN14AC2</b>	PM-□64, DP-100
	4-wire cable with connector, 5m	<b>CN14AC5</b>	PM-□64, DP-100
	4-wire cable with connector, 1m	<b>CN14HC1</b>	PM-□54
	4-wire cable with connector, 3m	<b>CN14HC3</b>	PM-□54
	3-wire cable with connector, 1m	<b>CN13C1</b>	PM2
	3-wire cable with connector, 3m	<b>CN13C3</b>	PM2
	3-wire main cable, 2m	<b>CN73C2</b>	FX-301□, FX311, FX-501□, FX-CH2□, SC-GU-1-485
	3-wire main cable, 5m	<b>CN73C5</b>	FX-301□, FX311, FX-501□, FX-CH2□, SC-GU-1-485
	1-wire sub cable, 2m	<b>CN71C2</b>	FX-301□, FX-311, FX-501□
	1-wire sub cable, 5m	<b>CN71C5</b>	FX-301□, FX-311, FX-501□
	4-wire main cable, 2m	<b>CN74C2</b>	FX-305□, FX-502□, LS-401□
	4-wire main cable, 5m	<b>CN74C5</b>	FX-305□, FX-502□, LS-401□
	2-wire sub cable, 2m	<b>CN72C2</b>	FX-305□, FX-502□, LS-401□
	2-wire sub cable, 5m	<b>CN72C5</b>	FX-305□, FX-502□, LS-401□
	3-wire cable with connector, 2m	<b>CN63C2</b>	DP4
	4-wire connecting cable between head and controller, with connector on both ends	<b>DPHCC2</b>	DP5/DPH
	6-wire cable with connector, 2m	<b>CN66C2</b>	DP5-C
	14-wire connecting cable, 2m	<b>HL-G1CCJ2</b>	HL-G1□-S-J
	14-wire connecting cable, 5m	<b>HL-G1CCJ5</b>	HL-G1□-S-J
	Cable with connector, 2m	<b>ANR81020J</b>	ANR12□

Photoelectric Sensors

Fiber Optic Sensors

Standard Fibers

Fiber Sensor Communication Units

Mark Sensors

Laser Sensors

Safety Sensors

Pressure & Flow Sensors

Inductive Proximity Sensors

Measurement Sensors









Ionizers / Electrostatic Sensors

Accessories

Index

Cable

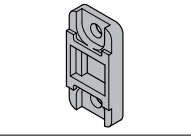
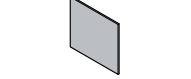
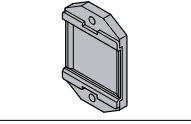
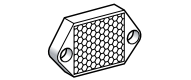
## Reflectors

Picture	Description	Model no.	Applicable Reflectors
	Reflection foil: 8x30mm, thickness 0.7mm	<b>RF11</b>	CX-400, EX-20, NX5
	Reflection foil: 25x30mm, thickness 0.7mm	<b>RF12</b>	CX-400, EX-20, NX5
	Reflection foil: 30x30mm, thickness 0.5mm	<b>RF13</b>	CX-400
	Reflective area: 9.6x17.5mm	<b>RF200</b>	EX-20
	Reflective area: 12,8x33.3mm	<b>RF210</b>	CX-400, EX-L200, NX5
	Reflective area: 42.3x35.3mm	<b>RF220</b>	CX-400, NX5
	Reflective area: 59.3x50.3mm	<b>RF230</b>	CX-400, LS-H92□, NX5
	Reflective area: 7x8mm	<b>RF310</b>	LS
	Reflection foil: 27.8 x25.2mm	<b>RF33</b>	LS
	Reflective area: 23x24mm	<b>RF330</b>	EX-L200, LS-H91□,
	Reflective area: 24x21mm	<b>RF-420</b>	CY-100
	Reflective area: 50x47mm	<b>RF-410</b>	CY-100
	Adhesive reflection tape: 22mm x 5m, thickness 0.4mm	<b>RF-40RL5</b>	CY-100

## ■ Mounting brackets

Picture	Description	Model no.	Applicable Reflectors
	L-shaped mounting bracket	<b>MS-EX20-1</b>	EX-L200
	Mounting plate	<b>MSLX1</b>	LX-100
	Mounting bracket	<b>MSCX1</b>	CX-400, LS
	Mounting bracket	<b>MSCX21</b>	CX-400
	Mounting bracket	<b>MSNX51</b>	NX5
	Mounting bracket	<b>MSEX101</b>	EX-10
	Mounting bracket	<b>MSEX201</b>	EX-20 Top sensing
	Mounting bracket	<b>MSEX202</b>	EX-20 Side sensing
	Mounting set, 4 mounting brackets M4(l=15mm) 4pcs., M4 (l=18mm) 8pcs.	<b>MSNA11</b>	NA1-11
	Mounting bracket	<b>MSEQ501</b>	EQ-500
	Mounting bracket	<b>MSEQ31</b>	EQ-30
	Mounting bracket	<b>MSDIN4</b>	FX-100
	Mounting bracket	<b>MSDIN2</b>	FX-300, FX-500
	Mounting bracket	<b>MS-FM2-1</b>	FM-200
	Mounting bracket	<b>MSDP11</b>	DP-100
	Mounting bracket	<b>MS-DP1-6</b>	DPC-100, DPC-L100
	Mounting bracket	<b>MSDPX</b>	DP2
	Mounting bracket	<b>MSDP3</b>	DP4, DP5
	Mounting bracket	<b>MSPE1</b>	DP-M
	Mounting bracket, stainless steel	<b>MS-CY1-1</b>	CY-100, CY-L100
	Mounting bracket for beam axis alignment, plastic	<b>MS-CY1-2</b>	CY-100, CY-L100

Photoelectric Sensors

Fiber Optic Sensors

Standard Fibers

Fiber Sensor Communication Units

Mark Sensors

Laser Sensors

Safety Sensors

Pressure & Flow Sensors

Inductive Proximity Sensors

Measurement Sensors

Ionizers / Electrostatic Sensors

Accessories

Index

Mounting brackets

# Index

<p>Photoelectric Sensors</p> <p>Fiber Optic Sensors</p> <p>Standard Fibers</p> <p>Fiber Sensor Communication Units</p> <p>Mark Sensors</p> <p>Laser Sensors</p> <p>Safety Sensors</p> <p>Pressure &amp; Flow Sensors</p> <p>Inductive Proximity Sensors</p> <p>Measurement Sensors</p> <p>Ionizers/ Electrostatic Sensors</p> <p>Accessories</p> <p>Index</p>	<p><b>A</b></p> <p>ANR1115 ..... 103</p> <p>ANR1150 ..... 103</p> <p>ANR1151 ..... 103</p> <p>ANR1182 ..... 103</p> <p>ANR1215 ..... 103</p> <p>ANR1226 ..... 103</p> <p>ANR1250 ..... 103</p> <p>ANR1251 ..... 103</p> <p>ANR1282 ..... 103</p> <p>ANR5131 ..... 103</p> <p>ANR5132 ..... 103</p> <p>ANR5141 ..... 103</p> <p>ANR5142 ..... 103</p> <p>ANR5231 ..... 103</p> <p>ANR5232 ..... 103</p> <p>ANR5241 ..... 103</p> <p>ANR5242 ..... 103</p> <p>ANR81020J ..... 125</p> <p><b>C</b></p> <p>CN13C1 ..... 125</p> <p>CN13C3 ..... 125</p> <p>CN14AC2 ..... 125</p> <p>CN14AC5 ..... 125</p> <p>CN14HC1 ..... 125</p> <p>CN14HC3 ..... 125</p> <p>CN63C2 ..... 125</p> <p>CN66C2 ..... 125</p> <p>CN71C2 ..... 125</p> <p>CN71C5 ..... 125</p> <p>CN72C2 ..... 125</p> <p>CN72C5 ..... 125</p> <p>CN73C2 ..... 125</p> <p>CN73C5 ..... 125</p> <p>CN74C2 ..... 125</p> <p>CN74C5 ..... 125</p> <p>CX-411-P(-Z) ..... 6</p> <p>CX-411(-Z) ..... 6</p> <p>CX-412-P(-Z) ..... 6</p> <p>CX-412(-Z) ..... 6</p> <p>CX-413-P(-Z) ..... 6</p> <p>CX-413(-Z) ..... 6</p> <p>CX-421-P(-Z) ..... 7</p> <p>CX-421(-Z) ..... 7</p> <p>CX-422-P(-Z) ..... 7</p> <p>CX-422(-Z) ..... 7</p> <p>CX-423-P(-Z) ..... 7</p> <p>CX-423(-Z) ..... 7</p> <p>CX-424-P(-Z) ..... 7</p> <p>CX-424(-Z) ..... 7</p> <p>CX-441-P(-Z) ..... 7</p> <p>CX-441(-Z) ..... 7</p> <p>CX-442-P(-Z) ..... 7</p> <p>CX-442(-Z) ..... 7</p> <p>CX-443-P(-Z) ..... 7</p> <p>CX-443(-Z) ..... 7</p> <p>CX-444-P(-Z) ..... 7</p> <p>CX-444(-Z) ..... 7</p> <p>CX-481-P(-Z) ..... 6</p> <p>CX-481(-Z) ..... 6</p> <p>CX-482-P(-Z) ..... 6</p> <p>CX-482(-Z) ..... 6</p> <p>CX-483-P(-Z) ..... 6</p> <p>CX-483(-Z) ..... 6</p> <p>CX-491-P(-Z) ..... 6</p> <p>CX-491(-Z) ..... 6</p> <p>CX-493-P(-Z) ..... 6</p> <p>CX-493(-Z) ..... 6</p> <p>CY-111A (-Z) ..... 11</p> <p>CY-111A-P (-Z) ..... 11</p> <p>CY-111B (-Z) ..... 11</p> <p>CY-111B-P (-Z) ..... 11</p> <p>CY-111VA-P(-Z) ..... 11</p> <p>CY-111VA(-Z) ..... 11</p> <p>CY-111VB-P(-Z) ..... 11</p> <p>CY-111VB(-Z) ..... 11</p> <p>CY-121A (-Z) ..... 11</p> <p>CY-121A-P (-Z) ..... 11</p> <p>CY-121B (-Z) ..... 11</p> <p>CY-121B-P (-Z) ..... 11</p> <p>CY-121VA-P(-Z) ..... 11</p> <p>CY-121VA(-Z) ..... 11</p> <p>CY-121VB-P(-Z) ..... 11</p> <p>CY-121VB(-Z) ..... 11</p> <p>CY-122A (-Z) ..... 11</p> <p>CY-122A-P (-Z) ..... 11</p> <p>CY-122B (-Z) ..... 11</p> <p>CY-122B-P (-Z) ..... 11</p> <p>CY-122VA-P(-Z) ..... 11</p> <p>CY-122VA(-Z) ..... 11</p> <p>CY-122VB-P(-Z) ..... 11</p> <p>CY-122VB(-Z) ..... 11</p> <p>CY-191A (-Z) ..... 11</p> <p>CY-191A-P (-Z) ..... 11</p> <p>CY-191B (-Z) ..... 11</p> <p>CY-191B-P (-Z) ..... 11</p> <p>CY-191VA-P(-Z) ..... 11</p> <p>CY-191VA(-Z) ..... 11</p> <p>CY-191VB-P(-Z) ..... 11</p> <p>CY-191VB(-Z) ..... 11</p> <p>CY-192A (-Z) ..... 11</p> <p>CY-192A-P (-Z) ..... 11</p> <p>CY-192B (-Z) ..... 11</p> <p>CY-192B-P (-Z) ..... 11</p> <p>CY-192VA-P(-Z) ..... 11</p> <p>CY-192VA(-Z) ..... 11</p> <p>CY-192VB-P(-Z) ..... 11</p> <p>CY-192VB(-Z) ..... 11</p> <p><b>D</b></p> <p>DP-101 ..... 81</p> <p>DP-101-E-P ..... 81</p> <p>DP-101-FE-P ..... 81</p> <p>DP-101-M-P ..... 81</p> <p>DP-101A ..... 81</p> <p>DP-101A-E-P ..... 81</p> <p>DP-101A-FE-P ..... 81</p> <p>DP-101A-M-P ..... 81</p> <p>DP-102 ..... 81</p> <p>DP-102-E-P ..... 81</p> <p>DP-102-FE-P ..... 81</p> <p>DP-102-M-P ..... 81</p> <p>DP-102A ..... 81</p> <p>DP-102A-E-P ..... 81</p> <p>DP-102A-FE-P ..... 81</p> <p>DP-102A-M-P ..... 81</p> <p>DP-111-E-P-J ..... 81</p> <p>DP-111A-E-P-J ..... 81</p> <p>DP-112-E-P-J ..... 81</p> <p>DP-112A-E-P-J ..... 81</p> <p>DP-M2 ..... 86</p> <p>DP-M2A ..... 86</p> <p>DP2-20 ..... 83</p> <p>DP2-21 ..... 83</p> <p>DP2-22 ..... 83</p> <p>DP2-40E ..... 83</p> <p>DP2-41 ..... 83</p> <p>DP2-41E ..... 83</p> <p>DP2-42 ..... 83</p> <p>DP2-42E ..... 83</p> <p>DP2-60 ..... 83</p> <p>DP2-60E ..... 83</p> <p>DP2-61 ..... 83</p> <p>DP2-61E ..... 83</p> <p>DP2-62 ..... 83</p> <p>DP2-62E ..... 83</p> <p>DP2-80 ..... 83</p> <p>DP4-50 ..... 85</p> <p>DP4-50P ..... 85</p> <p>DP4-52 ..... 85</p> <p>DP4-52P ..... 85</p> <p>DP4-57 ..... 85</p> <p>DP4-57P ..... 85</p> <p>DP5-C ..... 92</p> <p>DP5-C-P ..... 92</p> <p>DP-101 ..... 88</p> <p>DP-101-P ..... 88</p> <p>DPC-L101 ..... 90</p> <p>DPC-L101P ..... 90</p> <p>DPH-101 ..... 88</p> <p>DPH-101-M3 ..... 88</p> <p>DPH-101-M5 ..... 88</p> <p>DPH-102 ..... 88</p> <p>DPH-102-M5 ..... 88</p> <p>DPH-103 ..... 88</p> <p>DPH-103-M3 ..... 88</p> <p>DPH-103-M5 ..... 88</p> <p>DPH-A00 ..... 92</p> <p>DPH-A02 ..... 92</p> <p>DPH-A07 ..... 92</p> <p>DPH-A10 ..... 92</p> <p>DPH-A12 ..... 92</p> <p>DPH-A17 ..... 92</p> <p>DPH-L113 ..... 90</p> <p>DPH-L113V ..... 90</p> <p>DPH-L114 ..... 90</p> <p>DPH-L133 ..... 90</p> <p>DPH-L154 ..... 90</p> <p>DPHCC2 ..... 125</p> <p>EC-G01 ..... 123</p> <p>EF-S1C ..... 124</p> <p>EF-S1HS ..... 124</p> <p>EQ-34 (J) ..... 25</p> <p>EQ-34PN (J) ..... 25</p> <p>EQ-34W ..... 25</p> <p>EQ-501 ..... 24</p> <p>EQ-501T ..... 24</p> <p>EQ-502 ..... 24</p> <p>EQ-502T ..... 24</p> <p>EQ-511 ..... 24</p> <p>EQ-511T ..... 24</p> <p>EQ-512 ..... 24</p> <p>EQ-512T ..... 24</p> <p>ER-F12 ..... 114</p> <p>ER-F12S ..... 114</p> <p>ER-Q ..... 112</p> <p>ER-TF04-EX ..... 118</p> <p>ER-TF06-EX ..... 118</p> <p>ER-TF08-EX ..... 118</p> <p>ER-VS01 ..... 122</p> <p>ER-VW ..... 120</p> <p>ER-X016 ..... 116</p> <p>ER-X032 ..... 116</p> <p>ER-X048 ..... 116</p> <p>ER-X064 ..... 116</p> <p>ER-XC02 ..... 116</p> <p>EX-11A(-PN) ..... 13</p> <p>EX-11B(-PN) ..... 13</p> <p>EX-11EA(-PN) ..... 13</p> <p>EX-11EB(-PN) ..... 13</p> <p>EX-13A(-PN) ..... 13</p> <p>EX-13B(-PN) ..... 13</p> <p>EX-13EA(-PN) ..... 13</p> <p>EX-13EB(-PN) ..... 13</p> <p>EX-14A(-PN) ..... 13</p> <p>EX-14B(-PN) ..... 13</p> <p>EX-19A(-PN) ..... 13</p> <p>EX-19B(-PN) ..... 13</p> <p>EX-19EA(-PN) ..... 13</p> <p>EX-19EB(-PN) ..... 13</p> <p>EX-21A(-PN) ..... 15</p> <p>EX-21B(-PN) ..... 15</p> <p>EX-22A(-PN) ..... 15</p> <p>EX-22B(-PN) ..... 15</p> <p>EX-23(-PN) ..... 15</p> <p>EX-24A(-PN) ..... 15</p> <p>EX-24B(-PN) ..... 15</p> <p>EX-26A(-PN) ..... 15</p> <p>EX-26B(-PN) ..... 15</p> <p>EX-28A(-PN) ..... 15</p> <p>EX-28B(-PN) ..... 15</p> <p>EX-29A(-PN) ..... 15</p> <p>EX-29B(-PN) ..... 15</p> <p>EX-31A ..... 17</p> <p>EX-31A-PN ..... 17</p> <p>EX-31B ..... 17</p> <p>EX-31B-PN ..... 17</p> <p>EX-32A ..... 17</p> <p>EX-32A-PN ..... 17</p> <p>EX-32B ..... 17</p> <p>EX-32B-PN ..... 17</p> <p>EX-33 ..... 17</p> <p>EX-33-PN ..... 17</p> <p>EX-L211 ..... 63</p> <p>EX-L211P ..... 63</p> <p>EX-L212 ..... 63</p> <p>EX-L212P ..... 63</p> <p>EX-L221 ..... 63</p> <p>EX-L221P ..... 63</p> <p>EX-L261 ..... 63</p> <p>EX-L261P ..... 63</p> <p>EX-L262 ..... 63</p> <p>EX-L262P ..... 63</p> <p>EX-L291 ..... 63</p> <p>EX-L291P ..... 63</p> <p><b>F</b></p> <p>FD-30 ..... 41</p> <p>FD-31 ..... 43</p> <p>FD-31W ..... 43</p> <p>FD-32G ..... 43</p> <p>FD-32GX ..... 43</p> <p>FD-40 ..... 41</p> <p>FD-41 ..... 43</p> <p>FD-41S ..... 46</p> <p>FD-41SW ..... 46</p> <p>FD-41W ..... 43</p> <p>FD-42G ..... 43</p> <p>FD-42GW ..... 43</p> <p>FD-60 ..... 41</p> <p>FD-61 ..... 43</p> <p>FD-61G ..... 43</p> <p>FD-61S ..... 46</p> <p>FD-61W ..... 43</p> <p>FD-62 ..... 43</p> <p>FD-64X ..... 43</p> <p>FD-A16 ..... 48</p> <p>FD-AL11 ..... 48</p> <p>FD-E13 ..... 44</p> <p>FD-E13 ..... 46</p> <p>FD-E23 ..... 44</p> <p>FD-E23 ..... 46</p> <p>FD-EG30 ..... 43</p> <p>FD-EG30S ..... 46</p> <p>FD-EG31 ..... 43</p> <p>FD-F4 ..... 54</p> <p>FD-F41 ..... 54</p> <p>FD-F41Y ..... 54</p> <p>FD-F71 ..... 54</p> <p>FD-F8Y ..... 54</p> <p>FD-FA93 ..... 54</p> <p>FD-H13-FM2 ..... 52</p> <p>FD-H18-L31 ..... 52</p> <p>FD-H20-21 ..... 52</p> <p>FD-H20-M1 ..... 52</p> <p>FD-H25-L43 ..... 52</p> <p>FD-H25-L45 ..... 52</p> <p>FD-H30-KZ1V-S ..... 53</p> <p>FD-H30-L32 ..... 52</p> <p>FD-H30-L32V-S ..... 53</p> <p>FD-H35-20S ..... 52</p> <p>FD-H35-M2 ..... 52</p> <p>FD-H35-M2S6 ..... 52</p> <p>FD-HF40Y ..... 54</p> <p>FD-L10 ..... 49</p> <p>FD-L11 ..... 49</p> <p>FD-L12W ..... 49</p> <p>FD-L20H ..... 49</p> <p>FD-L21 ..... 49</p>
---	--



# Index

FD-L21W	49	FT-S21	44
FD-L22A	49	FT-S21W	44
FD-L23	49	FT-S30	41
FD-L30A	49	FT-S31W	44
FD-L31A	49	FT-S32	44
FD-L32H	49	FT-V23	45
FD-R60	43	FT-V24W	45
FD-S21	44	FT-V25	45
FD-S30	41	FT-V30	45
FD-S31	44	FT-V40	44
FD-S32	44	FT-V80Y	50
FD-S32W	44	FT-Z20HBW	47
FD-S33GW	44	FT-Z20W	47
FD-V30	46	FT-Z30	47
FD-V30W	46	FT-Z30E	47
FD-V50	46	FT-Z30EW	47
FD-Z20HBW	47	FT-Z30H	47
FD-Z20W	47	FT-Z30HW	47
FD-Z40HBW	47	FT-Z30W	47
FD-Z40W	47	FT-Z40HBW	47
FM-213-4	94	FT-Z40W	47
FM-213-4-P	94	FT-Z802Y	50
FM-214-4	94	FV-LE1	55
FM-214-4-P	94	FV-SV2	55
FM-215-8	94	FX-101 (-Z)	33
FM-215-8-P	94	FX-101-CC2	33
FM-216-AG2-P	94	FX-101P (-Z)	33
FM-216-AR2	94	FX-101P-CC2	33
FM-216-AR2-P	94	FX-102 (-Z)	33
FM-252-4	94	FX-102-CC2	33
FM-252-4-P	94	FX-102P (-Z)	33
FM-253-4	94	FX-102P-CC2	33
FM-253-4-P	94	FX-301-HS	35
FM-254-8	94	FX-301 (-B/-G/-H)	35
FM-254-8-P	94	FX-301 (-B/-G/-H)P	35
FM-255-AG2-P	94	FX-301P-HS	35
FM-255-AR2	94	FX-311	36
FM-255-AR2-P	94	FX-311P	36
FR-KZ22E	49	FX-501	38
FR-KZ50E	49	FX-501P	38
FR-KZ50H	49	FX-502	38
FR-Z50HW	49	FX-502P	38
FT-140	42	FX-505-C2	38
FT-30	41	FX-505P-C2	38
FT-31	42	FX-CH2	56
FT-31S	45	FX-CH2-P	56
FT-31W	42	FX-LE1	55
FT-40	41	FX-LE2	55
FT-42	42	FX-MR1	55
FT-42S	45	FX-MR2	55
FT-42W	42	FX-MR3	55
FT-43	42	FX-MR5	55
FT-45X	42	FX-MR6	55
FT-A11	48	FX-SV1	55
FT-A11W	48		
FT-A32	48		
FT-A32W	48		
FT-AL05	48		
FT-E13	44		
FT-E13	45		
FT-E23	44		
FT-E23	45		
FT-F93	54		
FT-H13-FM2	51		
FT-H20-J20-S	51		
FT-H20-J30-S	51		
FT-H20-J50-S	51		
FT-H20-M1	51		
FT-H20-VJ50-S	51		
FT-H20-VJ80-S	51		
FT-H20W-M1	51		
FT-H30-M1V-S	53		
FT-H35-M2	51		
FT-H35-M2S6	51		
FT-HL80Y	50		
FT-L80Y	50		
FT-R40	42		
FT-R41W	42		
FT-R42W	42		
FT-S11	44		
FT-S20	41		

## G

GP-XC10M	111
GP-XC10MP	111
GP-XC12ML	111
GP-XC12MLP	111
GP-XC22KL	111
GP-XC22KLP	111
GP-XC3SE	111
GP-XC3SEP	111
GP-XC5SE	111
GP-XC5SEP	111
GP-XC8S	111
GP-XC8SP	111
GX-F12 (-A/-B)(-I)(-P)	99
GX-F15(-A/-B)(-I)(-P)	99
GX-F6 (-A/-B)(-I)(-P)	99
GX-F8 (-A/-B)(-I)(-P)	99
GX-FL15 (-A/-B)(-I)(-P)	99
GX-H12 (-A/-B)(-I)(-P)	99
GX-H15 (-A/-B)(-I)(-P)	99
GX-H6 (-A/-B)(-I)(-P)	99
GX-H8 (-A/-B)(-I)(-P)	99
GX-HL15 (-A/-B)(-I)(-P)	99
GX-M12 (-A/-B)(-P)(-Z)	97
GX-M12(-A/-B)-U (-Z)	97

GX-M18 (-A/-B)(-P)(-Z)	97
GX-M18(-A/-B)-U (-Z)	97
GX-M30 (-A/-B)(-P)(-Z)	97
GX-M30(-A/-B)-U (-Z)	97
GX-M8 (-A/-B)(-P)(-Z)	97
GX-M8(-A/-B)-U	97
GX-MK12 (-A/-B)(-P)(-Z)	97
GX-MK18 (-A/-B)(-P)(-Z)	97
GX-MK30 (-A/-B)(-P)(-Z)	97
GX-ML12(-A/-B)-U (-Z)	97
GX-ML18(-A/-B)-U (-Z)	97
GX-ML30(-A/-B)-U (-Z)	97
GX-ML8(-A/-B)-U	97

## H

HL-AC1	109
HL-AC1P	109
HL-C1-M	105
HL-C1-M-WL	105
HL-C105B	105
HL-C105BBK	105
HL-C108B	105
HL-C108BBK	105
HL-C201F(-E)(-MK)	107
HL-C203F(-E)(-MK)	107
HL-C211F(-E)(-MK)	107
HL-C211F5(-E)(-MK)	107
HL-C2C	107
HL-C2C-P	107
HL-G103-A-C5	101
HL-G103-S-J	101
HL-G105-A-C5	101
HL-G105-S-J	101
HL-G108-A-C5	101
HL-G108-S-J	101
HL-G112-A-C5	101
HL-G112-S-J	101
HL-G1CCJ2	125
HL-G1CCJ5	125
HL-T1001A(F)	109
HL-T1005A(F)	109
HL-T1010A(F)	109
HLC135CBK10	105

## L

LS-401	65
LS-401-C2	65
LS-401P	65
LS-401P-C2	65
LS-H21(F) (-A)	65
LS-H22(F)	65
LS-H91(F) (-A)	65
LS-H92(F)	65
LX-101	61
LX-101-P	61
LX-101-P-Z	61
LX-101-Z	61

## M

MQ-W20A(R)	26
MQ-W20C(R)	26
MQ-W3A(R)	26
MQ-W3C(R)	26
MQ-W70A1224EMJ	26
MQ-W70C1224EMJ	26
MS-CY1-1	127
MS-CY1-2	127
MS-DP1-6	127
MS-EX20-1	127
MS-FM2-1	127
MSCX1	127
MSCX21	127
MSDIN2	127
MSDIN4	127
MSDP11	127
MSDP3	127
MSDPX	127
MSEQ31	127
MSEQ501	127

MSEX101	127
MSEX201	127
MSEX202	127
MSLX1	127
MSNA11	127
MSNX51	127
MSPE1	127
NA1-11	28
NA1-11-PN	28
NA1-PK3	30
NA1-PK3-PN	30
NA1-PK5	30
NA1-PK5-PN	30
NX5-D700A	9
NX5-D700B	9
NX5-M10RA	9
NX5-M10RB	9
NX5-M30A	9
NX5-M30B	9
NX5-PRVM5A	9
NX5-PRVM5B	9
NX5-RM7A	9
NX5-RM7B	9

## P

PM-F24	19
PM-F24P	19
PM-F44	19
PM-F44P	19
PM-F54	19
PM-F54P	19
PM-F64	19
PM-F64P	19
PM-K24	19
PM-K24P	19
PM-K44	19
PM-K44P	19
PM-K54	19
PM-K54P	19
PM-K64	19
PM-K64P	19
PM-L24	19
PM-L24P	19
PM-L44	19
PM-L44P	19
PM-L54	19
PM-L54P	19
PM-L64	19
PM-L64P	19
PM-□44	20
PM-□24	20
PM-□24P	20
PM-□44P	20
PM-□54	20
PM-□54P	20
PM-□64	20
PM-□64P	20
PM-R24	19
PM-R24P	19
PM-R44	19
PM-R44P	19
PM-R54	19
PM-R54P	19
PM-R64	19
PM-R64P	19
PM-T44	19
PM-T44P	19
PM-T54	19
PM-T54P	19
PM-T64	19
PM-T64P	19
PM-U24	19
PM-U24P	19
PM-Y44	19
PM-Y44P	19
PM-Y54	19
PM-Y54P	19
PM-Y64	19
PM-Y64P	19
PM2-LF10	22

Photoelectric Sensors
Fiber Optic Sensors
Standard Fibers
Fiber Sensor Communication Units
Mark Sensors
Laser Sensors
Safety Sensors
Pressure & Flow Sensors
Inductive Proximity Sensors
Measurement Sensors
Ionizers / Electrostatic Sensors
Accessories

## Index

Photoelectric Sensors	PM2-LF10	22	SF2B-A44-N	69	SF4B-F127<V2>	72
	PM2-LF10-C1	22	SF2B-A44-P	69	SF4B-F23<V2>	72
	PM2-LF10-C1	22	SF2B-A44SL	69	SF4B-F31<V2>	72
Fiber Optic Sensors	PM2-LF10B	22	SF2B-A48-N	69	SF4B-F39<V2>	72
	PM2-LF10B	22	SF2B-A48-P	69	SF4B-F47<V2>	72
	PM2-LF10B-C1	22	SF2B-A48SL	69	SF4B-F55<V2>	72
Standard Fibers	PM2-LF10B-C1	22	SF2B-A4SL	69	SF4B-F63<V2>	72
	PM2-LH10	22	SF2B-A6-N	69	SF4B-F71<V2>	72
Fiber Sensor Communication Units	PM2-LH10	22	SF2B-A6-P	69	SF4B-F79<V2>	72
	PM2-LH10-C1	22	SF2B-A6SL	69	SF4B-F95<V2>	72
	PM2-LH10-C1	22	SF2B-A8-N	69	SF4B-F□<V2>	71
Mark Sensors	PM2-LH10B	22	SF2B-A8-P	69	SF4B-H12<V2>	72
	PM2-LH10B	22	SF2B-A8SL	69	SF4B-H16<V2>	72
	PM2-LH10B-C1	22	SF2B-A□N	69	SF4B-H20<V2>	72
Laser Sensors	PM2-LH10B-C1	22	SF2B-A□P	69	SF4B-H24<V2>	72
	PM2-LL10	22	SF2B-H12-N	69	SF4B-H28<V2>	72
	PM2-LL10	22	SF2B-H12-P	69	SF4B-H32<V2>	72
Safety Sensors	PM2-LL10-C1	22	SF2B-H12SL	69	SF4B-H36<V2>	72
	PM2-LL10-C1	22	SF2B-H16-N	69	SF4B-H40<V2>	72
Pressure & Flow Sensors	PM2-LL10B	22	SF2B-H16-P	69	SF4B-H48<V2>	72
	PM2-LL10B	22	SF2B-H16SL	69	SF4B-H56<V2>	72
Inductive Proximity Sensors	PM2-LL10B-C1	22	SF2B-H20-N	69	SF4B-H64<V2>	72
	PM2-LL10B-C1	22	SF2B-H20-P	69	SF4B-H72<V2>	72
Measurement Sensors			SF2B-H20SL	69	SF4B-H80<V2>	72
			SF2B-H24-N	69	SF4B-H88<V2>	72
			SF2B-H24-P	69	SF4B-H96<V2>	72
Ionizers/Electrostatic Sensors	<b>R</b>		SF2B-H24SL	69	SF4B-H□<V2>	71
	RF-40RL5	126	SF2B-H28-N	69	SF4C-F15	74
	RF-410	126	SF2B-H28-P	69	SF4C-F15-J05	74
	RF-420	126	SF2B-H28SL	69	SF4C-F23	74
Accessories	RF11	126	SF2B-H32-N	69	SF4C-F23-J05	74
	RF12	126	SF2B-H32-P	69	SF4C-F31	74
	RF13	126	SF2B-H32SL	69	SF4C-F31-J05	74
	RF200	126	SF2B-H36-N	69	SF4C-F39	74
	RF210	126	SF2B-H36-P	69	SF4C-F39-J05	74
	RF220	126	SF2B-H36SL	69	SF4C-F47	74
	RF230	126	SF2B-H40-N	69	SF4C-F47-J05	74
	RF310	126	SF2B-H40-P	69	SF4C-F55	74
	RF33	126	SF2B-H40SL	69	SF4C-F55-J05	74
	RF330	126	SF2B-H48-N	69	SF4C-F63	74
			SF2B-H48-P	69	SF4C-F63-J05	74
			SF2B-H48SL	69	SF4C-F□	74
			SF2B-H56-N	69	SF4C-H12	74
			SF2B-H56-P	69	SF4C-H12-J05	74
			SF2B-H56SL	69	SF4C-H16	74
			SF2B-H64-N	69	SF4C-H16-J05	74
			SF2B-H64-P	69	SF4C-H20	74
			SF2B-H64SL	69	SF4C-H20-J05	74
			SF2B-H72-N	69	SF4C-H24	74
			SF2B-H72-P	69	SF4C-H24-J05	74
			SF2B-H72SL	69	SF4C-H28	74
			SF2B-H8-N	69	SF4C-H28-J05	74
			SF2B-H8-P	69	SF4C-H32	74
			SF2B-H80-N	69	SF4C-H32-J05	74
			SF2B-H80-P	69	SF4C-H8	74
			SF2B-H80SL	69	SF4C-H8-J05	74
			SF2B-H88-N	69	SF4C-H□	74
			SF2B-H88-P	69	SQ4-A21-N	78
			SF2B-H88SL	69	SQ4-A21-P	78
			SF2B-H8SL	69	SQ4-A22-N	78
			SF2B-H96-N	69	SQ4-A22-P	78
			SF2B-H96-P	69	SQ4-C11	78
			SF2B-H96SL	69	ST4-A1-J02	67
			SF2B-H□N	69	ST4-A1-J02V	67
			SF2B-H□P	69	ST4-A1-J1	67
			SF4B-A10G<V2>	72	ST4-A1-J1V	67
			SF4B-A12G<V2>	72	ST4-C11	67
			SF4B-A14G<V2>	72	ST4-C12EX	67
			SF4B-A16G<V2>	72		
			SF4B-A18G<V2>	72		
			SF4B-A20G<V2>	72	<b>U</b>	
			SF4B-A24G<V2>	72	UZZ80820D	125
			SF4B-A28G<V2>	72	UZZ80821D	125
			SF4B-A32G<V2>	72	UZZ80850D	125
			SF4B-A36G<V2>	72	UZZ80851D	125
			SF4B-A40G<V2>	72	UZZ81220D	125
			SF4B-A44G<V2>	72	UZZ81221D	125
			SF4B-A48G<V2>	72	UZZ81250D	125
			SF4B-A6G<V2>	72	UZZ81251D	125
			SF4B-A8G<V2>	72		
			SF4B-A□<V2>	71		
			SF4B-F111<V2>	72		

# Further Panasonic products

Panasonic Electric Works offers a wide product range from one source, from individual components to complete systems. Technology support for advice, design-in, installation and commissioning by our qualified application engineers round off the Panasonic service profile.



## Laser markers

Laser markers are ideal for non-contact, permanent labelling of most materials, e.g. metal, plastics, glass, paper, wood and leather. Several CO<sub>2</sub> laser marking systems and the FAYb laser marking systems can be easily integrated into existing production systems for a great variety of labelling tasks.



## Programmable controllers

Programmable controllers from Panasonic represent "control advantages" that pay for themselves right from the start.



## Servo drives

Panasonic servo drives enable high performance motion control to be applied to almost all types of machines, including chip mounting machines and general industrial machines.



## UV curing system

Aicure UJ30/35 is an LED curing system that quickly hardens UV-sensitive resins such as adhesives, ink and coatings. Its cutting edge LED technology is especially suited for precise, high-intensity curing.

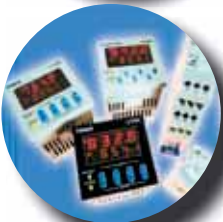

## FA components

Components such as Eco-POWER METER, timers/counters, temperature controllers, limit switches and fans round off our wide Factory Automation product range.



## Machine vision systems

Panasonic offers the complete range of high quality industrial machine vision systems. From the basic vision sensors to high-end inspection systems, 100% quality inspection and process control is assured.



## Human Machine Interfaces

Our compact, bright and easy-to-read Human Machine Interfaces can be used to visualize inspection results. Touch panels can even replace the standard keypad if you so desire.

North America

Europe

Asia Pacific

China

Japan

## Panasonic Electric Works

Please contact our Global Sales Companies in:

### Europe

▶ <b>Headquarters</b>	<b>Panasonic Electric Works Europe AG</b>	Rudolf-Diesel-Ring 2, 83607 Holzkirchen, Tel. +49 (0) 8024 648-0, Fax +49 (0) 8024 648-111, <a href="http://www.panasonic-electric-works.com">www.panasonic-electric-works.com</a>
▶ <b>Austria</b>	<b>Panasonic Electric Works Austria GmbH</b>	Josef Madersperger Str. 2, 2362 Biedermannsdorf, Tel. +43 (0) 2236-26846, Fax +43 (0) 2236-46133 <a href="http://www.panasonic-electric-works.at">www.panasonic-electric-works.at</a>
	<b>Panasonic Industrial Devices Materials Europe GmbH</b>	Ennsahfenstraße 30, 4470 Enns, Tel. +43 (0) 7223 883, Fax +43 (0) 7223 88333, <a href="http://www.panasonic-electronic-materials.com">www.panasonic-electronic-materials.com</a>
▶ <b>Benelux</b>	<b>Panasonic Electric Works Sales Western Europe B.V.</b>	De Rijn 4, (Postbus 211), 5684 PJ Best, (5680 AE Best), Netherlands, Tel. +31 (0) 499 372727, Fax +31 (0) 499 372185, <a href="http://www.panasonic-electric-works.nl">www.panasonic-electric-works.nl</a>
▶ <b>Czech Republic</b>	<b>Panasonic Electric Works Czech s.r.o.</b>	Sales Office Brno, Administrative centre PLATINIUM, Veverí 111, 616 00 Brno, Tel. +420 541 217 001, Fax +420 541 217 101, <a href="http://www.panasonic-electric-works.cz">www.panasonic-electric-works.cz</a>
▶ <b>France</b>	<b>Panasonic Electric Works Sales Western Europe B.V.</b>	Succursale française, 10, rue des petits ruisseaux, 91370 Verrières Le Buisson, Tél. +33 (0) 1 6013 5757, Fax +33 (0) 1 6013 5758, <a href="http://www.panasonic-electric-works.fr">www.panasonic-electric-works.fr</a>
▶ <b>Germany</b>	<b>Panasonic Electric Works Europe AG</b>	Rudolf-Diesel-Ring 2, 83607 Holzkirchen, Tel. +49 (0) 8024 648-0, Fax +49 (0) 8024 648-111, <a href="http://www.panasonic-electric-works.de">www.panasonic-electric-works.de</a>
▶ <b>Hungary</b>	<b>Panasonic Electric Works Europe AG</b>	Magyarországi Közvetlen Kereskedelmi Képviselő, 1117 Budapest, Neumann János u. 1., Tel. +36 1 999 89 26 <a href="http://www.panasonic-electric-works.hu">www.panasonic-electric-works.hu</a>
▶ <b>Ireland</b>	<b>Panasonic Electric Works UK Ltd.</b>	Irish Branch Office, Dublin, Tel. +353 (0) 14600969, Fax +353 (0) 14601131, <a href="http://www.panasonic-electric-works.co.uk">www.panasonic-electric-works.co.uk</a>
▶ <b>Italy</b>	<b>Panasonic Electric Works Italia srl</b>	Via del Commercio 3-5 (Z.I. Ferlina), 37012 Bussolengo (VR), Tel. +39 0456752711, Fax +39 0456700444, <a href="http://www.panasonic-electric-works.it">www.panasonic-electric-works.it</a>
▶ <b>Nordic Countries</b>	<b>Panasonic Electric Works Europe AG Panasonic Eco Solutions Nordic AB</b>	Filial Nordic, Knarrarnäsgatan 15, 164 40 Kista, Sweden, Tel. +46 859476680, Fax +46 859476690, <a href="http://www.panasonic-electric-works.se">www.panasonic-electric-works.se</a> Jungmansgatan 12, 21119 Malmö, Tel. +46 40 697 7000, Fax +46 40 697 7099, <a href="http://www.panasonic-fire-security.com">www.panasonic-fire-security.com</a>
▶ <b>Poland</b>	<b>Panasonic Electric Works Polska sp. z o.o.</b>	ul. Wołoska 9A, 02-583 Warszawa, Tel. +48 (0) 22 338-11-33, Fax +48 (0) 22 338-12-00, <a href="http://www.panasonic-electric-works.pl">www.panasonic-electric-works.pl</a>
▶ <b>Portugal</b>	<b>Panasonic Electric Works España S.A.</b>	Portuguese Branch Office, Avda Adelino Amaro da Costa 728 R/C J, 2750-277 Cascais, Tel. +351 214812520, Fax +351 214812529
▶ <b>Spain</b>	<b>Panasonic Electric Works España S.A.</b>	Barajas Park, San Severo 20, 28042 Madrid, Tel. +34 913293875, Fax +34 913292976, <a href="http://www.panasonic-electric-works.es">www.panasonic-electric-works.es</a>
▶ <b>Switzerland</b>	<b>Panasonic Electric Works Schweiz AG</b>	Grundstrasse 8, 6343 Rotkreuz, Tel. +41 (0) 41 7997050, Fax +41 (0) 41 7997055, <a href="http://www.panasonic-electric-works.ch">www.panasonic-electric-works.ch</a>
▶ <b>United Kingdom</b>	<b>Panasonic Electric Works UK Ltd.</b>	Sunrise Parkway, Linford Wood, Milton Keynes, MK14 6LF, Tel. +44 (0) 1908 231555, Fax +44 (0) 1908 231599, <a href="http://www.panasonic-electric-works.co.uk">www.panasonic-electric-works.co.uk</a>

### North & South America

▶ <b>USA</b>	<b>Panasonic Industrial Devices Sales Company of America</b>	629 Central Avenue, New Providence, N.J. 07974, Tel. 1-908-464-3550, Fax 1-908-464-8513, <a href="http://www.pewa.panasonic.com">www.pewa.panasonic.com</a>
--------------	--	---

### Asia Pacific/China/Japan

▶ <b>China</b>	<b>Panasonic Electric Works Sales (China) Co. Ltd.</b>	Level 2, Tower W3, The Towers Oriental Plaza, No. 2, East Chang An Ave., Dong Cheng District, Beijing 100738, Tel. +86-10-5925-5988, Fax +86-10-5925-5973
▶ <b>Hong Kong</b>	<b>Panasonic Industrial Devices Automation Controls Sales (Hong Kong) Co., Ltd.</b>	RM1205-9, 12/F, Tower 2, The Gateway, 25 Canton Road, Tsimshatsui, Kowloon, Hong Kong, Tel. +852-2956-3118, Fax +852-2956-0398
▶ <b>Japan</b>	<b>Panasonic Corporation</b>	1048 Kadoma, Kadoma-shi, Osaka 571-8686, Japan, Tel. +81-6-6908-1050, Fax +81-6-6908-5781, <a href="http://www.panasonic.net">www.panasonic.net</a>
▶ <b>Singapore</b>	<b>Panasonic Industrial Devices Automation Controls Sales Asia Pacific</b>	300 Beach Road, #16-01 The Concourse, Singapore 199555, Tel. +65-6390-3811, Fax +65-6390-3810