

POSIWIRE[®]

Cable Extension Position Sensors

WS10
Position Sensor

Datasheet



Copyright

© ASM GmbH
Am Bleichbach 18-24
85452 Moosinning
Germany

The information presented in this data sheet does not form part of any quotation or contract, is believed to be accurate and reliable and may be changed without notice. No liability will be accepted by ASM for any consequence of its use. Publication thereof does not convey nor imply any license under patent or industrial or intellectual property rights. Applications that are described herein for any of these products are for illustrative purpose only.

ASM makes no representation or warranty that such applications will be suitable for the specified use without further testing or modification.

Analog output, SSI output	5
Specifications	5
Order code	6
Dimensions	8
Measurement range 100 ... 1250 mm, analog output, SSI output	8
Magnetic encoder, analog output	9
Specifications	9
Order code	10
Magnetic encoder, analog output, programmable	11
Specifications	11
Order code	12
Magnetic encoder, digital output SSI	13
Specifications	13
Order code	14
Magnetic encoder, digital output CAN Bus.....	15
Specifications	15
Order code	16
Dimensions	17
Measurement range 250 ... 1250 mm, magnetic encoder output	17
Measurement range 1500 ... 2000 mm, magnetic encoder output	18
Incremental encoder output	19
Specifications	19
Order code	20
Dimensions	21
Measurement range 1250 mm, incremental encoder output	21
Output specifications	22
Analog outputs	22
Voltage divider R1K	22
Signal conditioner 10V and 10V5.....	23
Signal conditioner 420A	24
Signal conditioner 420T	25
Signal conditioner PMUI / PMUV	26
Analog output, programmable	30
Digital output SSI.....	32
Digital output CANopen	34
Digital output CAN SAE J1939	35
Incremental outputs	36
Signal conditioner PP530.....	36
Signal conditioner IE41LI and IE41HI	38
Accessories.....	40
Connector cable M12, 4 pin	40
Connector cable M12, 5 pin	41
Connector cable M12, 8 pin	42

Connector/bus cable - M12, 5 pin CAN-Bus	43
T-piece for bus cable M12, 5 pin CAN-Bus.....	43
Terminating resistance M12, 5 pin CAN-Bus.....	43
Plug-in connector M12, 8 pin (straight coupling)	44

Analog output, SSI output



Sensor features

- Measurement range up to 1250 mm
- Protection class IP65 (with mating connector only)
- Analog output, SSI output

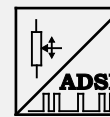
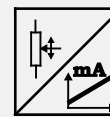
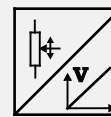
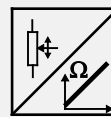

Specifications

Output	R1K = Potentiometer 1 kΩ 10V = Voltage 0 ... 10 V 420A = Current 4 ... 20 mA, 2 wire 420T = Current 4 ... 20 mA, 3 wire PMUI = Current output, programmable PMUV = Voltage output, programmable ADSI = Signal conditioner SSI 12 bit, replaced by MSS12 ADSI14 = Signal conditioner SSI 14 bit, replaced by MSS14 ADSI16 = Signal conditioner SSI 16 bit, replaced by MSS16
Resolution	Analog: quasi infinite
Linearity	±0.10% f.s. (standard) ±0.05% f.s. (optional)
Sensing device	Precision potentiometer
Housing material	Aluminium, stainless steel and plastic measuring cable: stainless steel
Protection class	IP65 (with mating connector only)
Connection	Connector M12, 8 pin
Temperature range	-20 ... +85 °C
Weight	approx. 550 g
EMC	DIN EN 61326-1:2013

Order code

WS10 – 1 – 2 – 3 – 4 – 5

1 Measurement range (in mm)

100 / 125 / 375 / 500 / 750 / 1000 / 1250

2 Output

- R1K** = Potentiometer 1 kΩ
- 10V** = Voltage 0 ... 10 V
- 420A** = Current 4 ... 20 mA, 2 wire
- 420T** = Current 4 ... 20 mA, 3 wire
- PMUI** = Current output, programmable
- PMUV** = Voltage output, programmable

- ADSI** = Signal conditioner SSI 12 bit, replaced by MSS12
- ADSI14** = Signal conditioner SSI 14 bit, replaced by MSS14
- ADSI16** = Signal conditioner SSI 16 bit, replaced by MSS16

3 Linearity

- L10** = ±0.10% f.s. (standard)
- L05** = ±0.05% f.s. (optional)

4 Cable fixing

- M4** = M4 cable fixing
- SB0** = cable clip

5 Connection

- M12** = Connector M12, 8 pin

Order example

WS10 – 1250 – 10V – L10 – M4 – M12

Accessories:

Connector cable (see page 42)

Cable forces typical at = 20 °C	Measurement range	Maximum pull-out force	Minimum pull-in force
	[mm]	[N]	[N]
	100	4,7	3,0
	125	4,6	2,4
	375	7,4	3,9
	500	5,5	2,8
	750	7,6	3,8
	1000	5,3	2,9
	1250	4,6	2,4

Dimensions

Measurement range 100 ... 1250 mm, analog output, SSI output

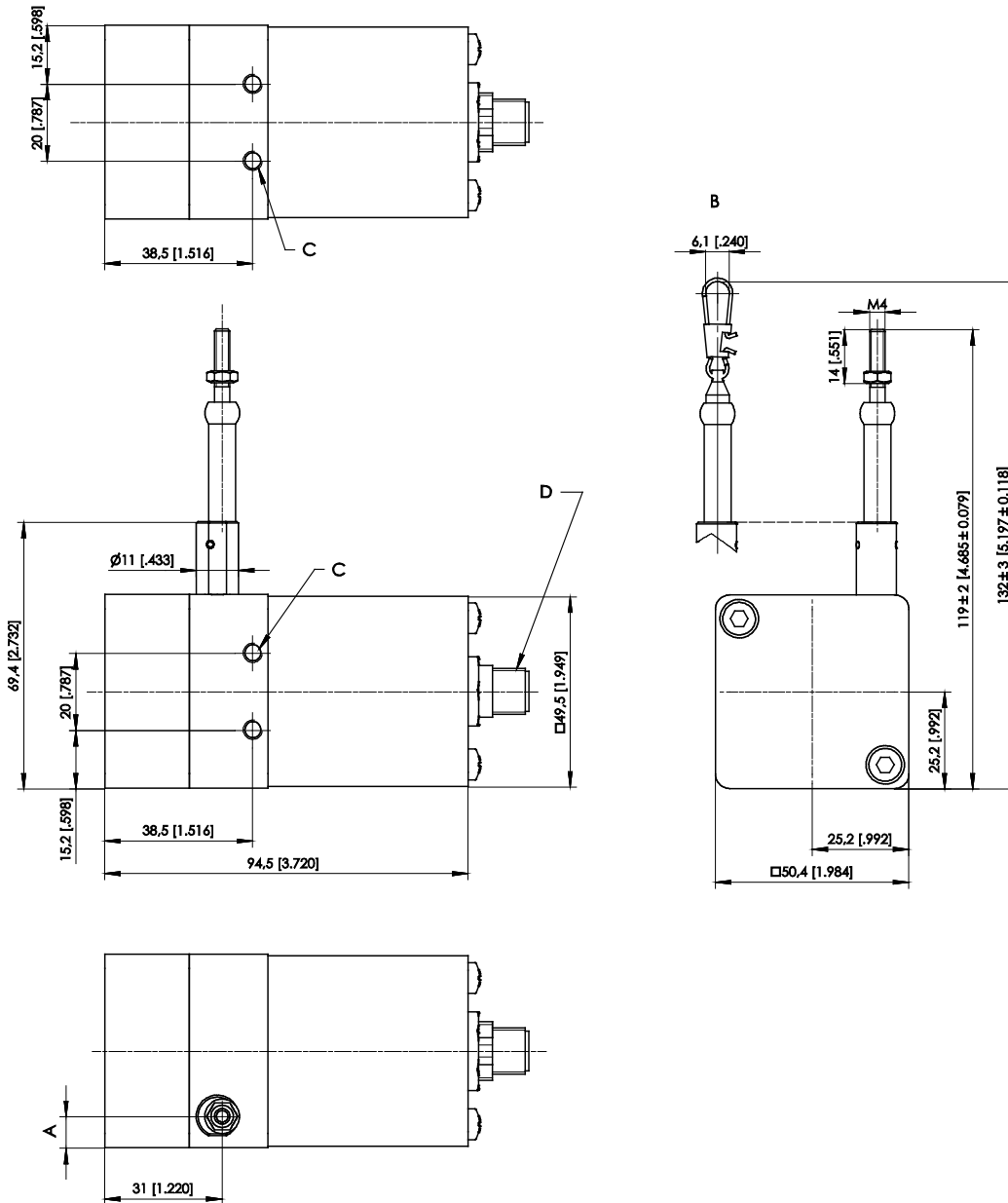

Dimensions in mm	Measurement range	A
		375; 750
	100; 125; 500; 1000; 1250	8.2

B – Option SB0
C – M5 - 8 [.315] deep
D – Connector M12

Dimensions in mm [inch]
Dimensions informative only.
For guaranteed dimensions consult factory.

Magnetic encoder, analog output



Sensor features

- With magnetic absolute encoder
- Measurement range up to 2000 mm
- Protection class IP65 (with mating connector only)
- Analog output
- Absolute measurement

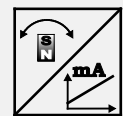
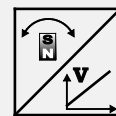

Specifications

Output	U2 = Voltage 0.5 ... 10 V U8 = Voltage 0.5 ... 4.5 V I1 = Current 4 ... 20 mA, 3 wire
Resolution	<0.002% f.s.
Linearity	±0.10% f.s. (standard) ±0.05% f.s. (optional)
Sensing device	Magnetic absolute encoder
Housing material	Aluminium, stainless steel and plastic measuring cable: stainless steel
Protection class	IP65 (with mating connector only)
Connection	Connector M12, 5 pin (standard) Connector M12, 8 pin (optional)
Shock	DIN EN 60068-2-27:2010, 100 g/11 ms, 100 shocks
Vibration	DIN EN 60068-2-6:2008, 20 g 10 Hz-2 kHz, 10 cycles
Temperature range	-20 ... +85 °C
Weight	approx. 550 g
EMC	DIN EN 61326-1:2013

Order code

WS10 – 1 – 2 – 3 – 4 – 5 – 6

1 Measurement range (in mm)

250 / 375 / 500 / 750 / 1000 / 1250 / 1500 / 2000

2 Output

U2 = Voltage 0.5 ... 10 V
U8 = Voltage 0.5 ... 4.5 V
I1 = Current 4 ... 20 mA, 3 wire

3 Signal characteristics

A = increasing signal (e.g. 4 ... 20 mA)
D = decreasing signal (e.g. 20 ... 4 mA)

4 Linearity

L10 = ±0.10% f.s. (standard)
L05 = ±0.05% f.s. (optional)

5 Cable fixing

M4 = M4 cable fixing
SB0 = cable clip

6 Connection

M12A5 = Connector M12, 5 pin (standard)
M12A8 = Connector M12, 8 pin (optional)

Order example

WS10 – 1250 – U2 – A – L10 – M4 – M12A5

Accessories:

Connector cable (see page 40)

Magnetic encoder, analog output, programmable



Sensor features

- With magnetic absolute encoder
- Measurement range up to 2000 mm
- Protection class IP65 (with mating connector only)
- Analog output, programmable
- Absolute measurement

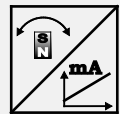
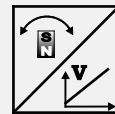

Specifications

Output	U2/PMU = Voltage 0.5 ... 10 V, programmable U8/PMU = Voltage 0.5 ... 4.5 V, programmable I1/PMU = Current 4 ... 20 mA, 3 wire, programmable
Resolution	<0.002% f.s.
Linearity	±0.10% f.s. (standard) ±0.05% f.s. (optional)
Sensing device	Magnetic absolute encoder
Housing material	Aluminium, stainless steel and plastic measuring cable: stainless steel
Protection class	IP65 (with mating connector only)
Connection	Connector M12, 5 pin
Shock	DIN EN 60068-2-27:2010, 100 g/11 ms, 100 shocks
Vibration	DIN EN 60068-2-6:2008, 20 g 10 Hz-2 kHz, 10 cycles
Temperature range	-20 ... +85 °C
Weight	approx. 550 g
EMC	DIN EN 61326-1:2013

Order code

WS10 – 1 – 2 – 3 – 4 – 5 – 6

1 Measurement range (in mm)

250 / 375 / 500 / 750 / 1000 / 1250 / 1500 / 2000

2 Output

U2/PMU = Voltage 0.5 ... 10 V, programmable
U8/PMU = Voltage 0.5 ... 4.5 V, programmable
I1/PMU = Current 4 ... 20 mA, 3 wire, programmable

3 Signal characteristics

A = increasing signal (e.g. 4 ... 20 mA)
D = decreasing signal (e.g. 20 ... 4 mA)

4 Linearity

L10 = ±0.10% f.s. (standard)
L05 = ±0.05% f.s. (optional)

5 Cable fixing

M4 = M4 cable fixing
SB0 = cable clip

6 Connection

M12A5 = Connector M12, 5 pin

Order example

WS10 – 1250 – U2/PMU – A – L10 – M4 – M12A5

Accessories:

Connector cable (see page 41)

Magnetic encoder, digital output SSI



Sensor features

- With magnetic absolute encoder
- Measurement range up to 2000 mm
- Protection class IP65 (with mating connector only)
- Digital output SSI
- Absolute measurement



Specifications

Output	MSSI = SSI synchronous serial interface
Resolution	10 / 50 / 100
Linearity	±0.10% f.s. (standard) ±0.05% f.s. (optional)
Sensing device	Magnetic absolute encoder
Housing material	Aluminium, stainless steel and plastic measuring cable: stainless steel
Protection class	IP65 (with mating connector only)
Connection	Connector M12, 8 pin
Shock	DIN EN 60068-2-27:2010, 100 g/11 ms, 100 shocks
Vibration	DIN EN 60068-2-6:2008, 20 g 10 Hz-2 kHz, 10 cycles
Temperature range	-20 ... +85 °C
Weight	approx. 550 g
EMC	DIN EN 61326-1:2013

Order code

WS10 – 1 – 2 – 3 – 4 – 5 – 6

1 Measurement range (in mm)

250 / 375 / 500 / 750 / 1000 / 1250 / 1500 / 2000

2 Resolution (in µm)

10 / 50 / 100

3 Output

MSSI = SSI synchronous serial interface

4 Linearity

L10 = ±0.10% f.s. (standard)
L05 = ±0.05% f.s. (optional)

5 Cable fixing

M4 = M4 cable fixing
SB0 = cable clip

6 Connection

M12A8 = Connector M12, 8 pin

Order example

WS10 – 1250 – 50 – MSSI – L10 – M4 – M12A8

Accessories:

Connector cable (see page 42)

Magnetic encoder, digital output CAN Bus



Sensor features

- With magnetic absolute encoder
- Measurement range up to 2000 mm
- Protection class IP65 (with mating connector only)
- Digital output CAN Bus
- Absolute measurement
- Optional redundant CAN Bus



Specifications

Output	MCANOP = CANopen MCANJ1939 = CAN SAE J1939
Resolution	setting via CAN Bus
Linearity	±0.10% f.s. (standard) ±0.05% f.s. (optional)
Sensing device	Magnetic absolute encoder
Housing material	Aluminium, stainless steel and plastic measuring cable: stainless steel
Protection class	IP65 (with mating connector only)
Connection	Connector M12, 5 pin
Temperature range	-20 ... +85 °C
Weight	approx. 550 g
EMC	DIN EN 61326-1:2013

Order code

WS10 – 1 – 2 – 3 – 4 – 5

1 Measurement range (in mm)

250 / 375 / 500 / 750 / 1000 / 1250 / 1500 / 2000

2 Output

MCANOP = CANopen
MCANJ1939 = CAN SAE J1939

3 Linearity

L10 = ±0.10% f.s. (standard)
L05 = ±0.05% f.s. (optional)

4 Cable fixing

M4 = M4 cable fixing
SB0 = cable clip

5 Connection

M12/CAN = Connector M12, 5 pin

Order example

WS10 – 1250 – MCANOP – L10 – M4 – M12/CAN

Accessories:

Connector cable (see page 43)

Dimensions

Measurement range 250 ... 1250 mm, magnetic encoder output

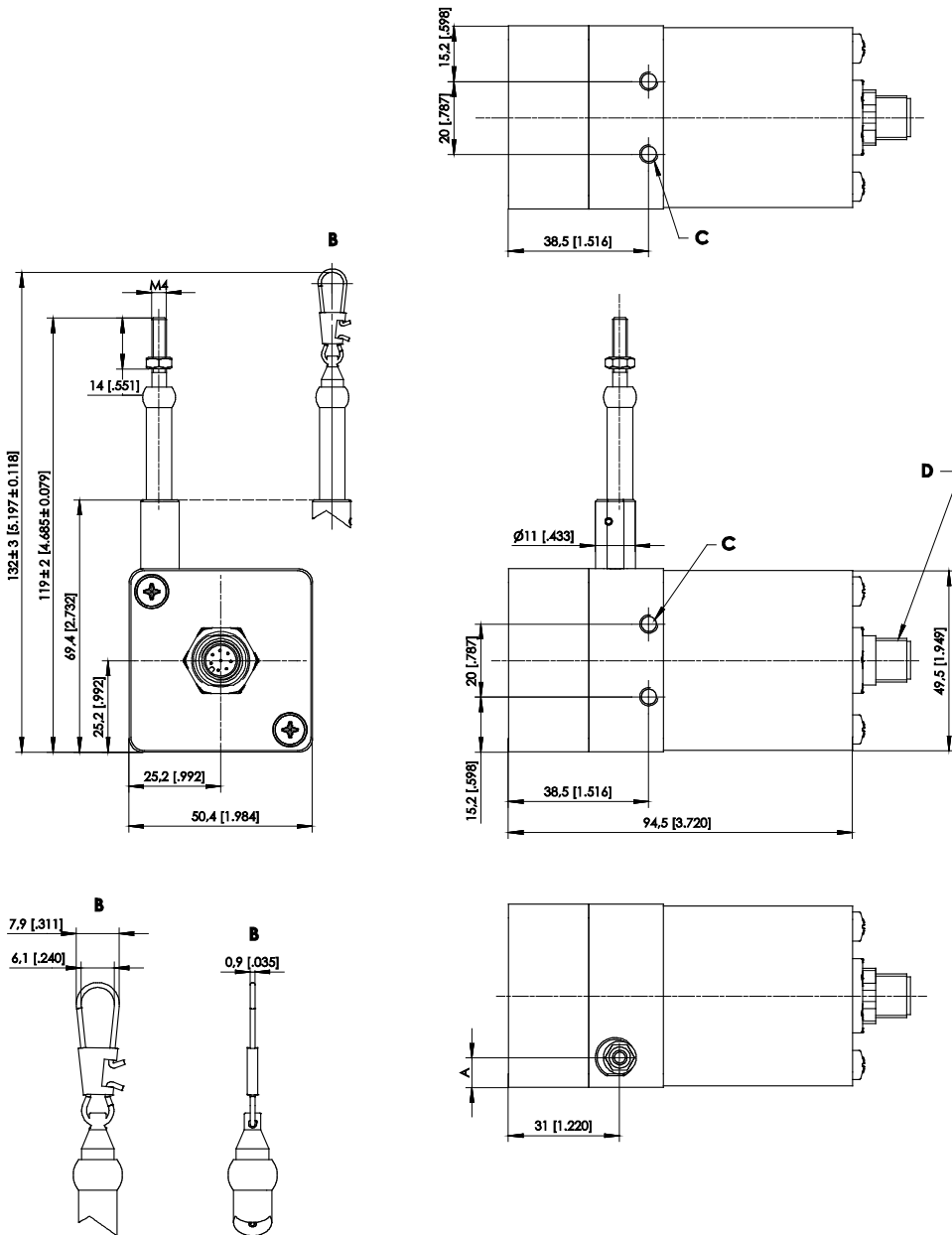

Dimensions in mm	Measurement range	A
	250	16.7
	375; 750	12.7
	500; 1000; 1250	8.2

A – Option SB0

B – Mounting drillings 4 x M5 - 8 [0.315] deep

C – Connector M12

Dimensions in mm [inch]

Dimensions informative only.

For guaranteed dimensions consult factory.

Measurement range 1500 ... 2000 mm, magnetic encoder output

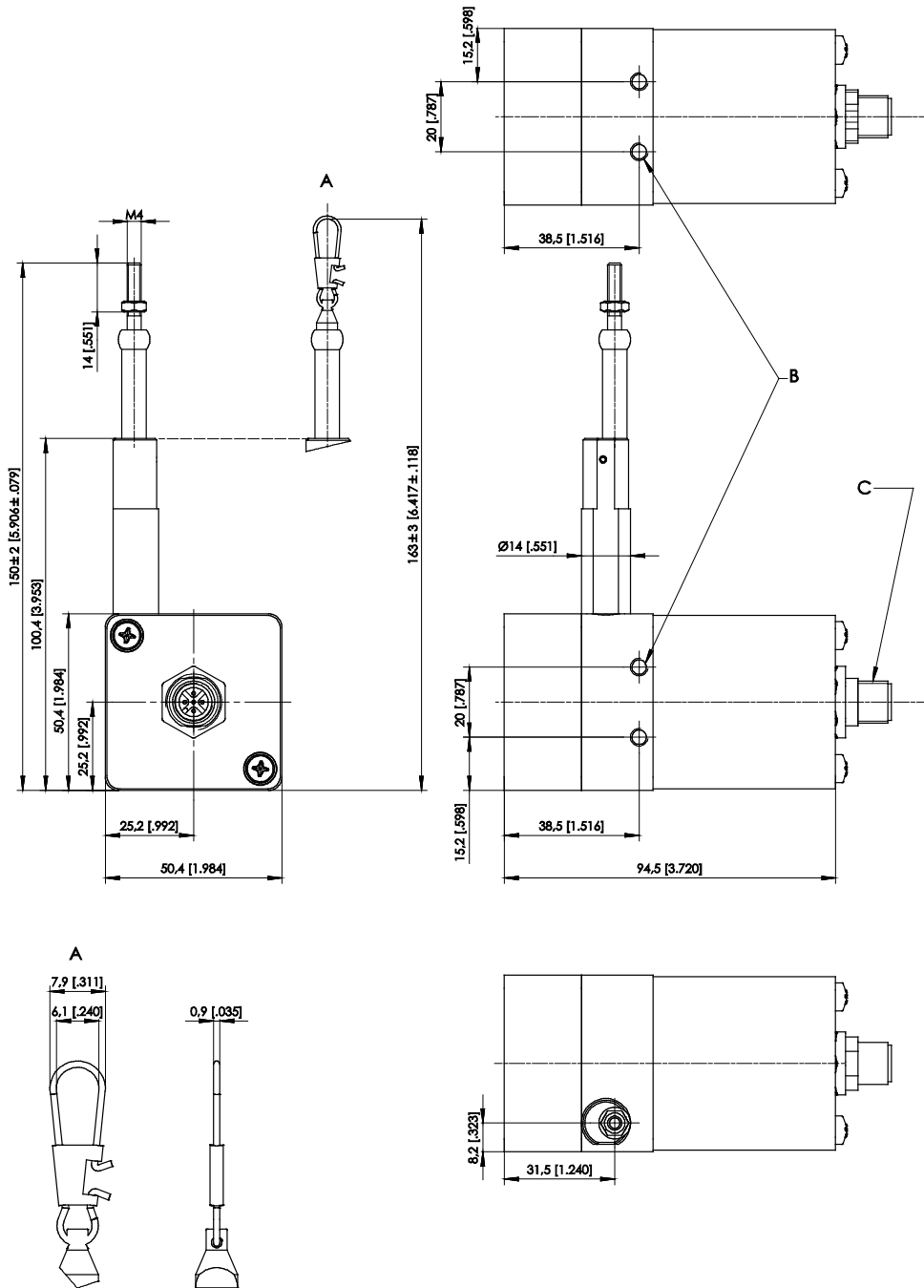

- A – Option SB0
- B – M5 - 8 [3.15] deep
- C – Connector M12

Dimensions in mm [inch]
Dimensions informative only.
For guaranteed dimensions consult factory.

Incremental encoder output



Sensor features

- Measurement range up to 1250 mm
- Protection class IP65 (with mating connector only)
- Incremental encoder output

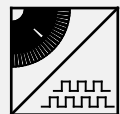

Specifications

Output	PP530 = Incremental output 5 ... 30 V IE41LI = Incremental encoder TTL compatible IE41HI = Incremental encoder HTL compatible
Resolution	10 or 25 pulses / mm (40 or 100 edges / mm)
Linearity	±0.05% f.s.
Sensing device	Incremental encoder
Housing material	Aluminium, stainless steel and plastic measuring cable: stainless steel
Protection class	IP65 (with mating connector only)
Connection	Connector M12, 8 pin
Temperature range	-20 ... +85 °C
Weight	approx. 550 g
EMC	DIN EN 61326-1:2013

Cable forces	Measurement range	Maximum pull-out force	Minimum pull-in force
Typical at = 20 °C	[mm]	[N]	[N]
	1250	5,8	3,0

Order code

WS10 – 1 – 2 – 3 – 4 – 5

1 Measurement range (in mm)

1250

2 Resolution

10 = 10 pulses / mm
25 = 25 pulses / mm
 other number of pulses on request

3 Output

PP530 = Incremental output 5 ... 30 V
IE41LI = Incremental encoder TTL compatible
IE41HI = Incremental encoder HTL compatible

4 Cable fixing

M4 = M4 cable fixing
SB0 = cable clip

5 Connection

M12 = Connector M12, 8 pin

Order example

WS10 – 1250 – 10 – PP530 – M4 – M12

Accessories:

Connector cable (see page 42)

Dimensions

Measurement range 1250 mm, incremental encoder output

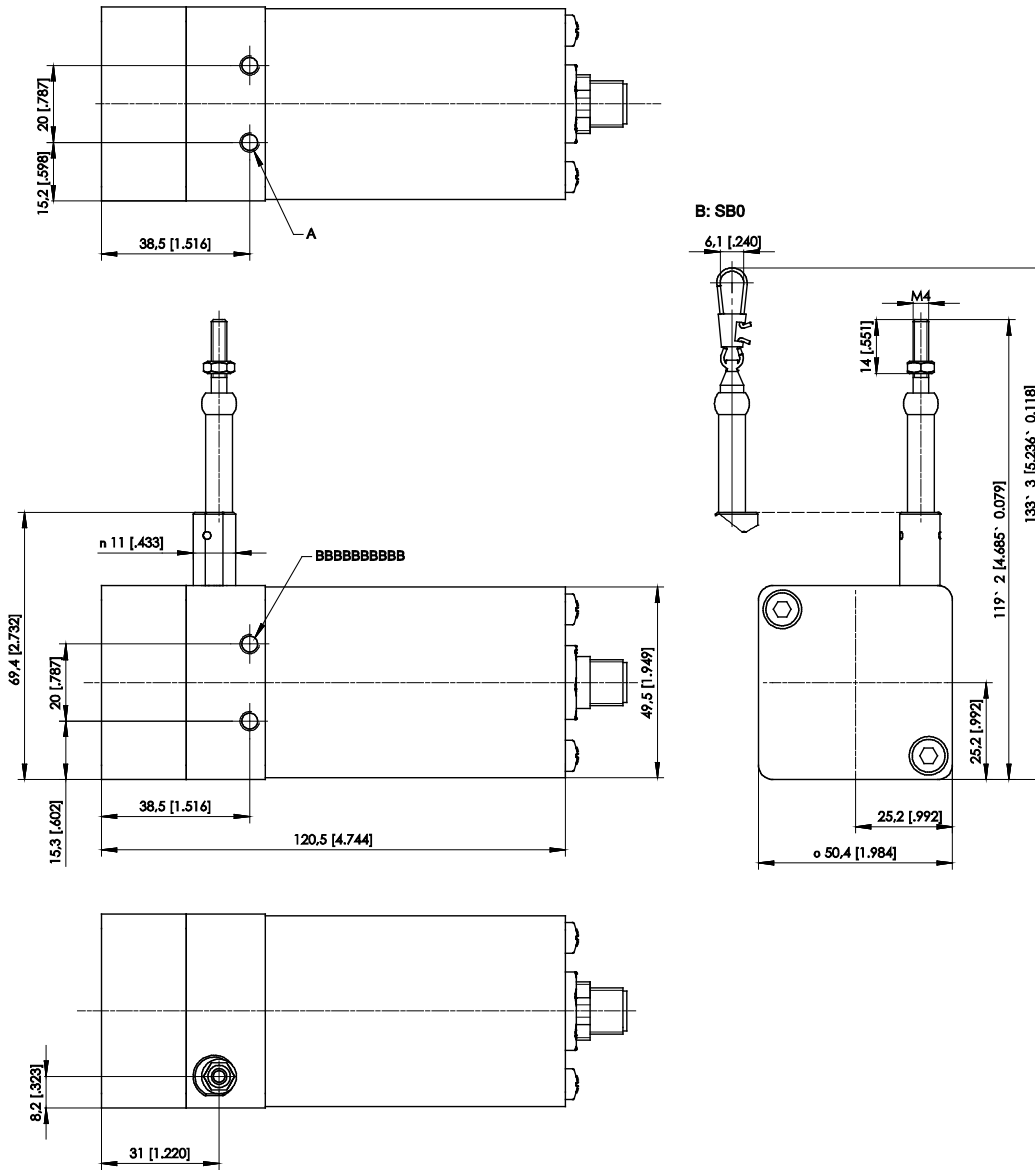

A – M5 - 8 [.315] deep
B – Option SB0

Dimensions in mm [inch]
Dimensions informative only.
For guaranteed dimensions consult factory.

Output specifications

Analog outputs

Voltage divider R1K

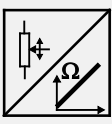
Potentiometer 	Excitation voltage	32 V DC max. at 1 kΩ (max. power 1 W)
	Potentiometer impedance	1 kΩ ±10 %
	Thermal coefficient	±25 x 10 ⁻⁶ / °C f.s.
	Sensitivity	Depends on the measuring range, individual sensitivity of the sensor is specified on the label
	Voltage divider utilization range	approx. 3 % ... 97 %
	Operating temperature	Refer to output specification
	EMC	DIN EN 61326-1:2013

Output signals

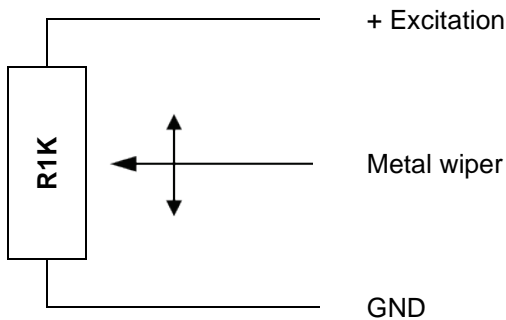

Note:

The metal wiper of the potentiometer must be protected against current load!

Electrical current flow impact on the wiper causes linearity errors and shortens the lifetime of the potentiometer.

Additional information:

http://www.asm-sensor.com/asm/pdf/pro/ws_poti_technote_en.pdf

Signal wiring

Signal	Connector pin no.	Cable color	Cable color
Poti +	1	white	brown
Poti GND	2	brown	white
Poti slider	3	green	blue
-	4	yellow	black
-	5	grey	-
-	6	pink	-
-	7	blue	-
-	8	red	-

View to sensor connector



CONN-M12-8F

Signal conditioner 10V and 10V5

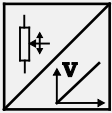
Voltage output 	Excitation voltage	18 ... 27 V DC non stabilized
	Excitation current	20 mA max.
	Output voltage	10V: 0 ... 10 V DC; 10V5: 0.5 ... 10 V DC
	Output current	2 mA max.
	Output load	> 5 kΩ
	Stability (temperature)	$\pm 50 \times 10^{-6} / ^\circ\text{C}$ f.s.
	Protection	Reverse polarity, short circuit
	Output noise	0.5 mV _{RMS}
	Operating temperature	Refer to output specification
	EMC	DIN EN 61326-1:2013

Output signals

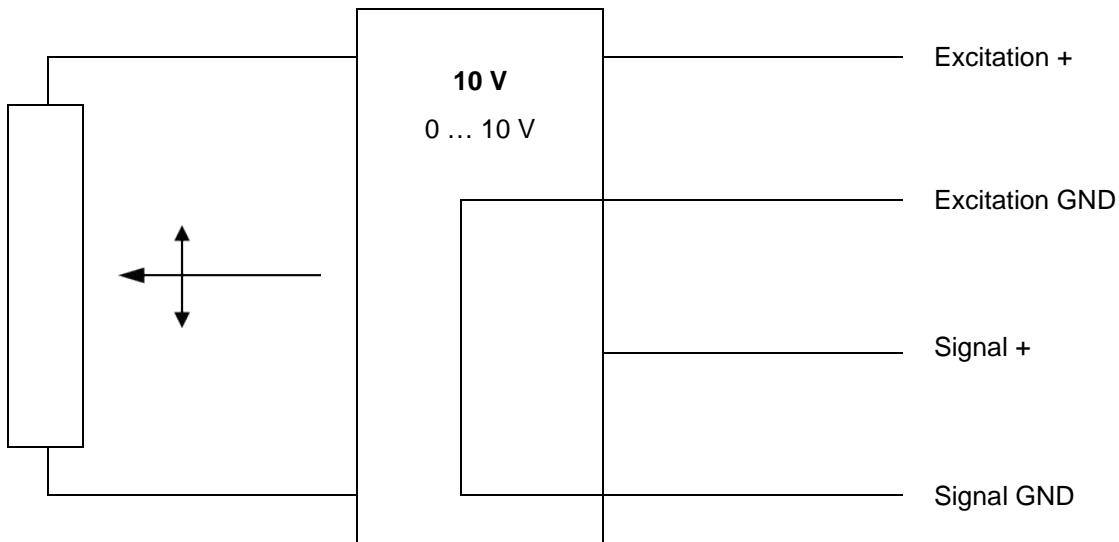

Signal wiring

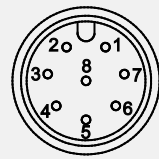
Signal	Connector pin no.	Cable color	View to sensor connector
Excitation +	1	white	
Excitation GND	2	brown	
Signal +	3	green	
Signal GND	4	yellow	
Not connected	5	grey	
Not connected	6	pink	
Not connected	7	blue	
Not connected	8	red	

Signal conditioner 420A

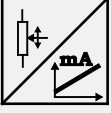
Current output (2 wire) 	Excitation voltage	12 ... 27 V DC non stabilized, measured at the sensor terminals
	Excitation current	35 mA max.
	Output current	4 ... 20 mA equivalent for 0 ... 100 % range
	Stability (temperature)	$\pm 100 \times 10^{-6} / ^\circ\text{C}$ f.s.
	Protection	Reversed polarity, short circuit
	Output noise	0.5 mV _{eff}
	Operating temperature	Refer to output specification
	EMC	DIN EN 61326-1:2013

Output signals

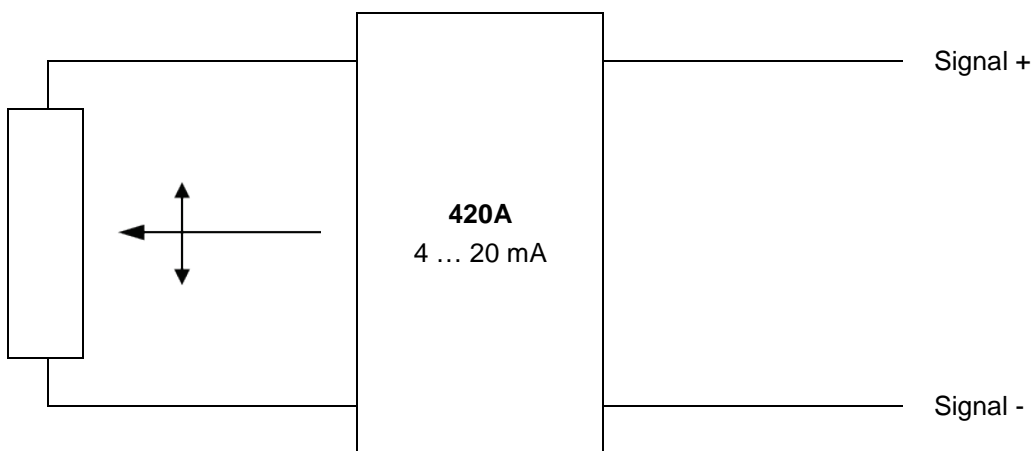

Signal wiring

Signal	Connector pin no.	Cable color	View to sensor connector
Signal +	1	white	 CONN-M12-8F
Signal -	2	brown	
Not connected	3	green	
Not connected	4	yellow	
Not connected	5	grey	
Not connected	6	pink	
Not connected	7	blue	
Not connected	8	red	

Signal conditioner 420T

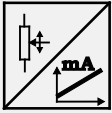
Current output (3 wire)	Excitation voltage	18 ... 27 V DC non stabilized
	Excitation current	40 mA max.
	Load resistor	350 Ω max.
	Output current	4 ... 20 mA equivalent for 0 ... 100 % range
	Stability (temperature)	$\pm 50 \times 10^{-6} / ^\circ\text{C}$ f.s.
	Protection	Reverse polarity, short circuit
	Output noise	0.5 mV _{RMS}
	Operating temperature	Refer to output specification
	EMC	DIN EN 61326-1:2013

Output signals

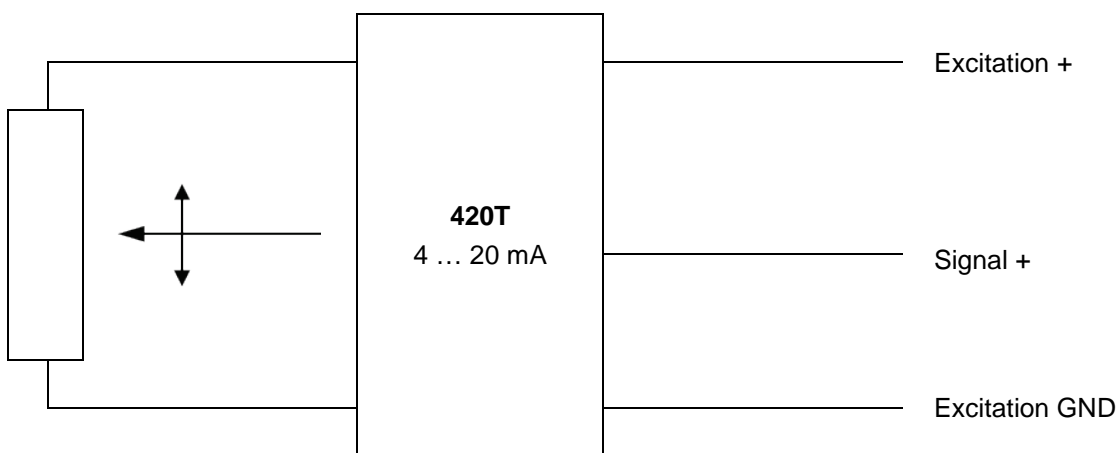

Signal wiring

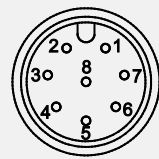
Signal	Connector pin no.	Cable color	View to sensor connector
Excitation +	1	white	
Excitation GND	2	brown	
Signal +	3	green	
Not connected	4	yellow	
Not connected	5	grey	
Not connected	6	pink	
Not connected	7	blue	
Not connected	8	red	

Signal conditioner PMUI / PMUV

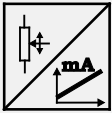
Voltage or current output (3 wire)	Excitation voltage	18 ... 27 V DC
	Excitation current	50 mA max.
	Voltage output PMUV	0 ... 10 V
	Output current	10 mA max.
	Output load	1 kΩ min.
	Current output PMUI	4 ... 20 mA (3 wire)
	Working resistance	500 Ω max.
	Scaling	
	Activation of offset and gain adjust	Connect with excitation GND (0 V)
	Scalable range	90 % max. f.s.
	Stability (temperature)	±50 x 10 ⁻⁶ / °C f.s.
	Operating temperature	Refer to output specification
	Protection	Reversed polarity, short circuit
	EMC	DIN EN 61326-1:2013

Output signals

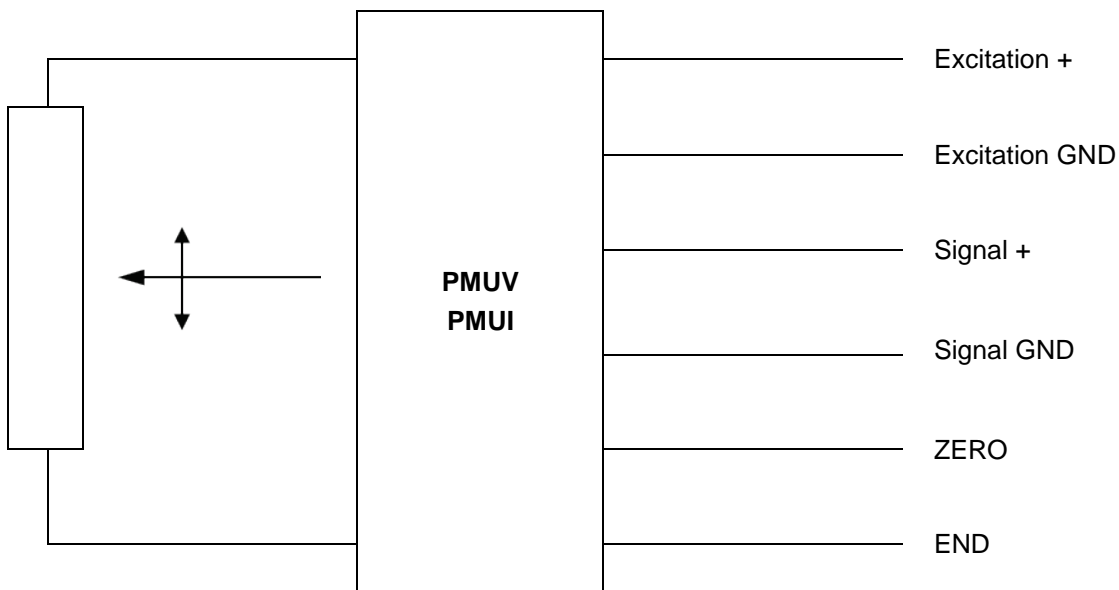

Signal wiring PMUV / PMUI

Signal	Connector pin no.	Cable color	View to sensor connector
Excitation +	1	white	 <p>CONN-M12-8F</p>
Excitation GND	2	brown	
Signal +	3	green	
Signal GND	4	yellow	
Not connected	5	grey	
Not connected	6	pink	
ZERO	7	blue	
END	8	red	

Signal wiring PMUI2

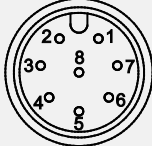
Signal	Connector pin no.	Cable color	View to sensor connector
Excitation +	1	white	 <p>CONN-M12-8F</p>
Excitation GND	2	brown	
Not connected	3	green	
Not connected	4	yellow	
Signal +	5	grey	
Signal GND	6	pink	
ZERO	7	blue	
END	8	red	

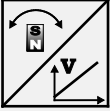
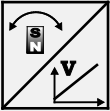
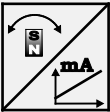
<p>U2</p> <p>Voltage output 0.5 ... 10 V</p> 	Excitation voltage	8 ... 36 V DC
	Excitation current	20 mA typical at 24 V DC 38 mA typical at 12 V DC max. 50 mA
	Output voltage	0.5 ... 10 V DC
	Output current	2 mA max.
	Measuring rate	1 kHz standard
	Stability (temperature)	$\pm 50 \times 10^{-6} / ^\circ\text{C}$ f.s. (typical)
	Protection	Reverse polarity, short circuit
	Operating temperature	See specification of the respective sensor
	EMC	DIN EN 61326-1:2013
<p>U8</p> <p>Voltage output 0.5 ... 4.5 V</p> 	Excitation voltage	8 ... 36 V DC
	Excitation current	17 mA typical at 24 V DC 32 mA typical at 12 V DC 50 mA max.
	Output voltage	0.5 ... 4.5 V DC
	Output current	2 mA max.
	Measuring rate	1 kHz standard
	Stability (temperature)	$\pm 50 \times 10^{-6} / ^\circ\text{C}$ f.s. (typical)
	Protection	Reverse polarity, short circuit
	Operating temperature	See specification of the respective sensor
	EMC	DIN EN 61326-1:2013
<p>I1</p> <p>Current output 4 ... 20 mA, 3 wires</p> 	Excitation voltage	8 ... 36 V DC
	Excitation current	typical 36 mA at 24 V DC typical 70 mA at 12 V DC 120 mA max.
	Load R_L	500 Ω max.
	Output current	4 ... 20 mA
	Measuring rate	1 kHz standard
	Stability (temperature)	$\pm 50 \times 10^{-6} / ^\circ\text{C}$ f.s. (typical)
	Protection	Reverse polarity, short circuit
	Operating temperature	See specification of the respective sensor
	EMC	DIN EN 61326-1:2013

Signal wiring

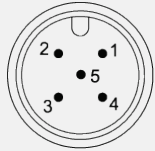
Signal	Connector pin no.	Cable connection	View to the sensor connector
Excitation +	1	brown	
Signal	2	white	
GND	3	blue	
Do not connect!	4	black	
Do not connect!	5	(grey)	

Signal diagram

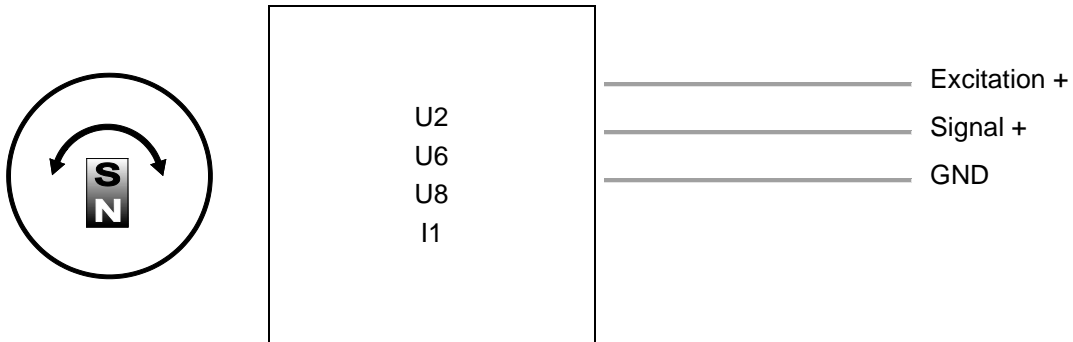

Analog output, programmable

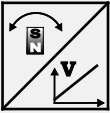
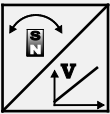
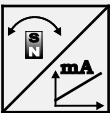
U2/PMU Voltage output 0.5 ... 10 V 	Excitation voltage	8 ... 36 V DC
	Excitation current	20 mA typical at 24 V DC 38 mA typical at 12 V DC max. 50 mA
	Output voltage	0,5 ... 10 V DC
	Output current	2 mA max.
	Measuring rate	1 kHz standard
	Stability (temperature)	$\pm 50 \times 10^{-6} / ^\circ\text{C}$ f.s. (typical)
	Protection	Reverse polarity, short circuit
	Operating temperature	See specification of the respective sensor
	EMC	EN 61326-1:2013
U8/PMU Voltage output 0.5 ... 4.5 V 	Excitation voltage	8 ... 36 V DC
	Excitation current	17 mA typical at 24 V DC 32 mA typical at 12 V DC max. 50 mA
	Output voltage	0.5 ... 4.5 V DC
	Output current	2 mA max.
	Measuring rate	1 kHz standard
	Stabilität (Temperatur)	$\pm 50 \times 10^{-6} / ^\circ\text{C}$ f.s. (typical)
	Protection	Reverse polarity, short circuit
	Operating temperature	See specification of the respective sensor
	EMC	DIN EN 61326-1:2013
I1/PMU Current output 4 ... 20 mA, 3 wires 	Excitation voltage	8 ... 36 V DC
	Excitation current	typical 36 mA at 24 V DC typical 70 mA at 12 V DC max. 120 mA
	Load R_L	500 Ω max.
	Output current	4 ... 20 mA
	Measuring rate	1 kHz standard
	Stability (temperature)	$\pm 50 \times 10^{-6} / ^\circ\text{C}$ f.s. (typical)
	Protection	Reverse polarity, short circuit
	Operating temperature	See specification of the respective sensor
	EMC	DIN EN 61326-1:2013

Signal wiring

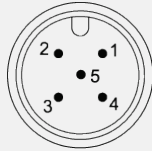
Signal	Connector pin no.	Cable color	View to sensor connector
Excitation +	1	brown	
Signal	2	white	
GND	3	blue	
Do not connect!	4	black	
SPAN/ZERO	5	grey	

Signal diagram

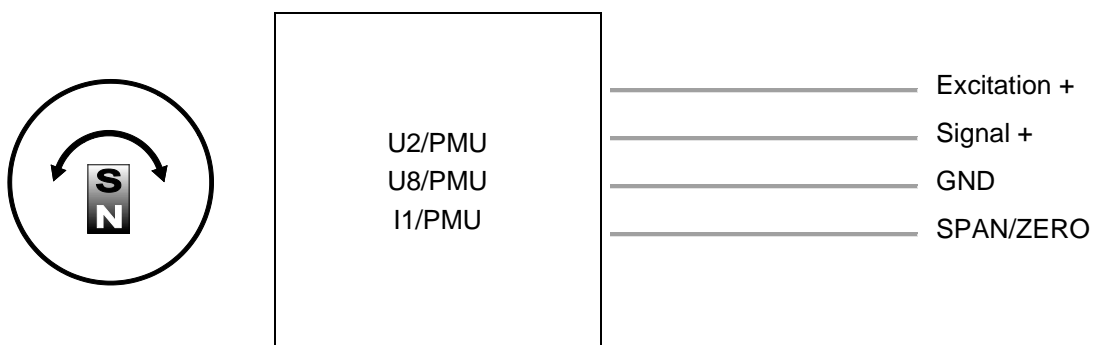

Option -PMU

Programming of the start and end value by the customer

Teach-In of start and end value for the options U2/PMU, I1/PMU, U8/PMU is provided by a binary signal SPAN/ZERO. At the start position connect signal SPAN/ZERO for a period of 2 ... 3 seconds to GND via push button. At the end position connect signal SPAN/ZERO for a period of 5 ... 6 seconds to GND via a push button. The scaling taught in that way will be stored non-volatile.

To reset the sensor to factory default signal ZERO/END must be connected to ground while powering up the sensor for 2 ... 3 seconds. For the option PMZ only teach-in of ZERO position is possible.

Digital output SSI

MSSI Synchronous serial SSI 	Interface	EIA RS-422
	Excitation voltage	8 ... 36 V DC
	Excitation current	19 mA typical at 24 V DC 35 mA typical at 12 V DC max. 80 mA
	Clock frequency	100 kHz ... 500 kHz
	Code	Gray-Code, continuous progression
	Delay between pulse trains (t_p)	30 μ s min.
	Stability (temperature)	$\pm 50 \times 10^{-6} / ^\circ\text{C}$ f.s. (typical)
	Operating temperature	See specification of the respective sensor
	Protection	Reverse polarity, short circuit
	EMC	DIN EN 61326-1:2013

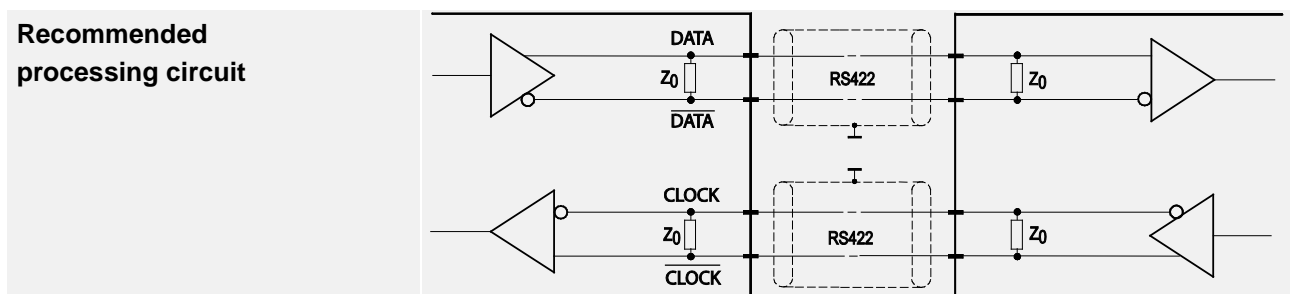
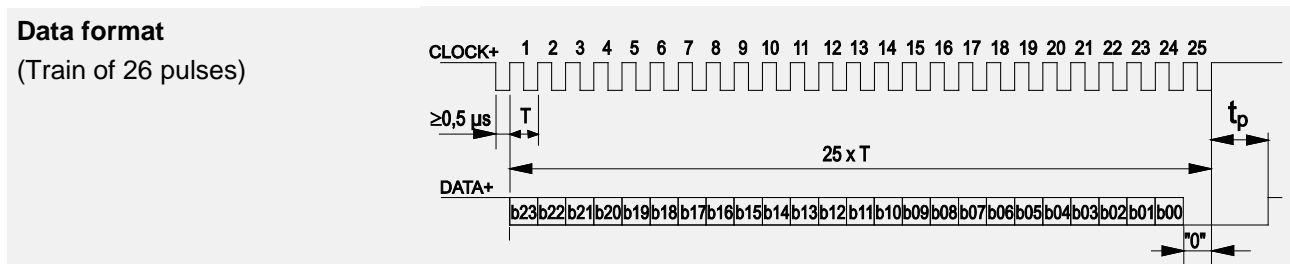

Transmission rate	Cable length	Baud rate	Note: Extension of the cable length will reduce the maximum transmission rate.
	50 m	100-400 kHz	
	100 m	100-300 kHz	

Signal wiring

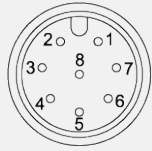
Signal	Connector pin no.	Cable color	View to sensor connector
Excitation +	1	white	
Excitation GND	2	brown	
CLOCK	3	green	
$\overline{\text{CLOCK}}$	4	yellow	
DATA	5	grey	
$\overline{\text{DATA}}$	6	pink	
-	7	blue	
-	8	red	

Digital output CANopen

MCANOP, CANOPR CANopen 	CAN specification	ISO 11898, Basic and Full CAN 2.0 B
	Communication profile	CANopen CiA 301 V 4.02, Slave
	Encoder profile	Encoder CiA 406 V 3.2
	Error Control	Node Guarding, Heartbeat, Emergency Message
	Node ID	Adjustable via LSS, default: 127
	PDO	3 TxPDO, 0 RxPDO, no linking, static mapping
	PDO Modes	Event-/Time triggered, Remote-request, Sync cyclic/acyclic
	SDO	1 Server, 0 Client
	CAM	8 cams
	Certified	Yes
	Transmission rate	50 kBit bis 1 Mbit, adjustable via LSS, default: 125 kBit
	Bus connection	M12 connector, 5 pin
	Integrated bus terminating resistor	120Ω adjustable by the customer
	Bus, galvanic isolated	no

Specifications	Excitation voltage	8 ... 36 V DC
	Excitation current	20 mA typical at 24 V DC 40 mA typical at 12 V DC 80 mA max.
	Measuring rate	1 kHz (asynchronous)
	Stability (temperature)	$\pm 50 \times 10^{-6}/^{\circ}\text{C}$ f.s. (typical)
	Repeatability	1 LSB
	Operating temperature	See specification of the respective sensor
	Protection	Reverse polarity, short circuit
	Dielectric strength	1 kV (V AC, 50 Hz, 1 min.)
	EMC	EN 61326-1:2013

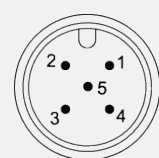
Signal wiring	Signal	Connector pin no.	View to the sensor connector
	Shield	1	
	Excitation +	2	
	GND	3	
	CAN-H	4	
	CAN-L	5	

Digital output CAN SAE J1939

MCANJ1939/R CAN SAE J1939 	CAN Specification	ISO 11898, Basic and Full CAN 2.0 B
	Transceiver	24V-compliant, not isolated
	Communication profile	SAE J1939
	Baud Rate	250 kbit/s
	Internal termination resistor	120 Ω adjustable by the customer
	Address	Default 247d, configurable

NAME Fields	Arbitrary address capable	1	Yes
	Industry group	0	Global
	Vehicle system	7Fh (127d)	Non specific
	Vehicle system instance	0	
	Function	FFh (255d)	Non specific
	Function instance	0	
	ECU instance	0	
	Manufacturer	145h (325d)	Manufacturer ID
	Identity number	0nnn	Serial number 21 bit

Parameter Group Numbers (PGN)	Configuration data	PGN EF00h	Proprietary-A (PDU1 peer-to-peer)
	Process data	PGN FFnnh	Proprietary-B (PDU2 broadcast); nn Group Extension (PS) configurable

Specifications	Excitation voltage	8 ... 36 V DC
	Excitation current	20 mA typical at 24 V DC 40 mA typical at 12 V DC, max. 80 mA
	Measuring rate	1 kHz (asynchronous)
	Stability (temperature)	±50 x 10 ⁻⁶ /°C f.s. (typical)
	Repeatability	1 LSB
	Operating temperature	See specification of the respective sensor
	Protection	Reverse polarity, short circuit
	Dielectric strength	1 kV (V AC, 50 Hz, 1 min.)
EMV	EN 61326-1:2013	

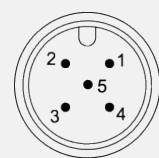
Signal wiring	Signal	Connector pin no.	View to the sensor connector
	Shield	1	
	Excitation +	2	
	GND	3	
	CAN-H	4	
	CAN-L	5	

Incremental outputs

Signal conditioner PP530

Incremental 	Excitation voltage	5 ... 30 V DC
	Excitation current	25 mA typ. (w/o load), 200 mA max.
	Output frequency	200 kHz max.
	Output	Linedriver, Push-Pull, CMOS, TTL and HTL compatible
	Output current	30 mA max.
	Output voltage	Depends on the excitation voltage
	Saturation voltage high/low	$I_a < 10 \text{ mA}, U_b \text{ 5 V/24 V: } < 0,5 \text{ V}$ $I_a < 30 \text{ mA}, U_b \text{ 5 V/24 V: } < 1 \text{ V}$
	Stability (temperature)	$\pm 20 \times 10^{-6} / ^\circ\text{C}$ f.s. (sensor mechanism)
	Operation temperature	-10 ... +70 °C
	Storage temperature	-30 ... +80 °C
	Transition time positive edge	< 200 ns
	Transition time negative edge	< 200 ns
	Protection	Reverse polarity, short circuit
	EMC	DIN EN 61326-1:2013

Output signals

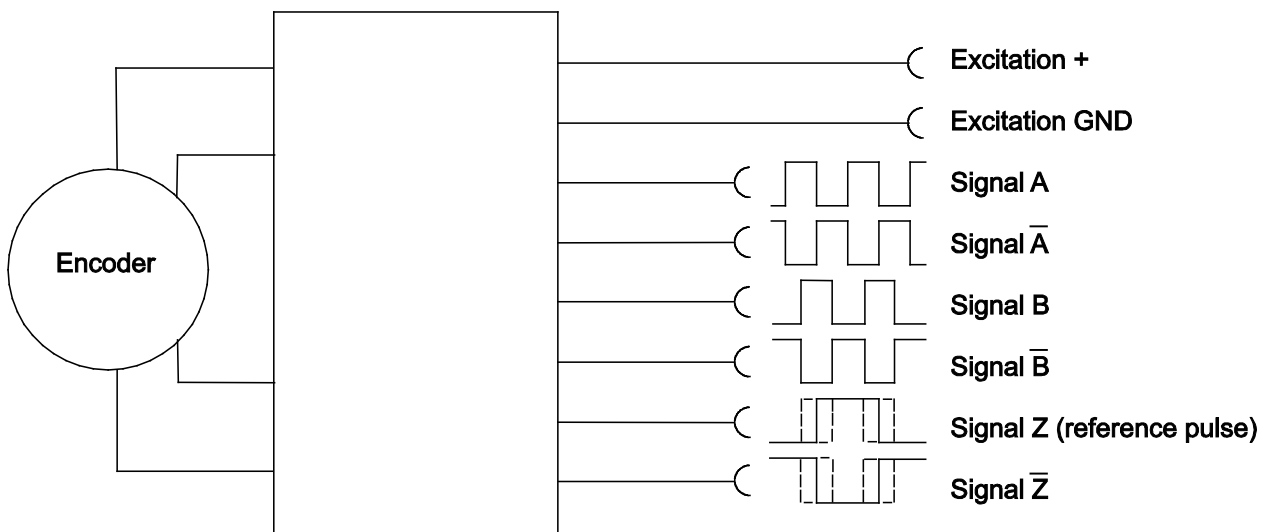

Recommended processing circuit

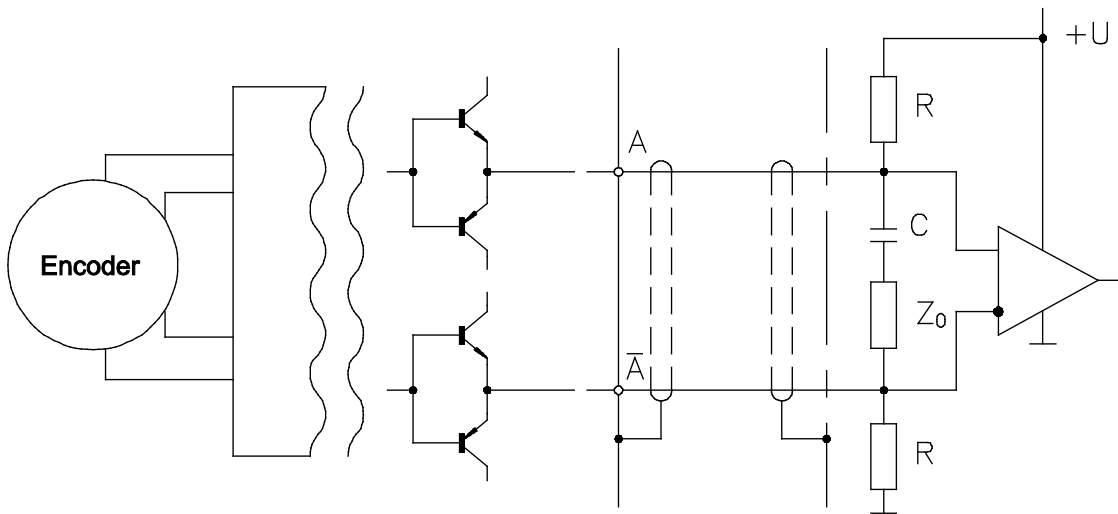

Signal wiring

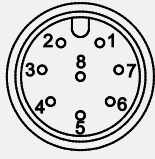
Signal	Connector pin no.	Cable color	View to sensor connector
Excitation +	1	white	 <p>CONN-M12-8F</p>
Excitation GND	2	brown	
Signal A	4	yellow	
Signal \bar{A}	6	pink	
Signal B (A + 90°)	3	green	
Signal \bar{B}	5	grey	
Signal Z (reference pulse)	7	blue	
Signal \bar{Z}	8	red	

Signal conditioner IE41LI and IE41HI

Incremental 		IE41LI	IE41HI
	Excitation voltage	5 V DC ±10 %	10 ... 30 V DC
	Excitation current	150 mA max. (w/o load)	
	Output frequency	300 kHz max.	200 kHz max.
	Output	RS422	Push-pull antivalent
	Output current	±30 mA max.	30 mA
	Output voltage	Depending on the excitation voltage	
	Stability (temperature)	±20 x 10 ⁻⁶ / °C f.s. (sensor mechanism)	
	Operating temperature	-10 ... +70 °C	
	Protection against short circuit	One channel for 1 s	yes
	EMC	DIN EN 61326-1:2013	

Signal wiring WS10

Signal	Connector pin no.	Cable color	View to sensor connector
Excitation +	1	white	 CONN-M12-8F
Excitation GND	2	brown	
Signal A	4	yellow	
Signal \bar{A}	6	pink	
Signal B (A + 90°)	3	green	
Signal \bar{B}	5	grey	
Signal Z (reference pulse)	7	blue	
Signal \bar{Z}	8	red	

Recommended processing circuit

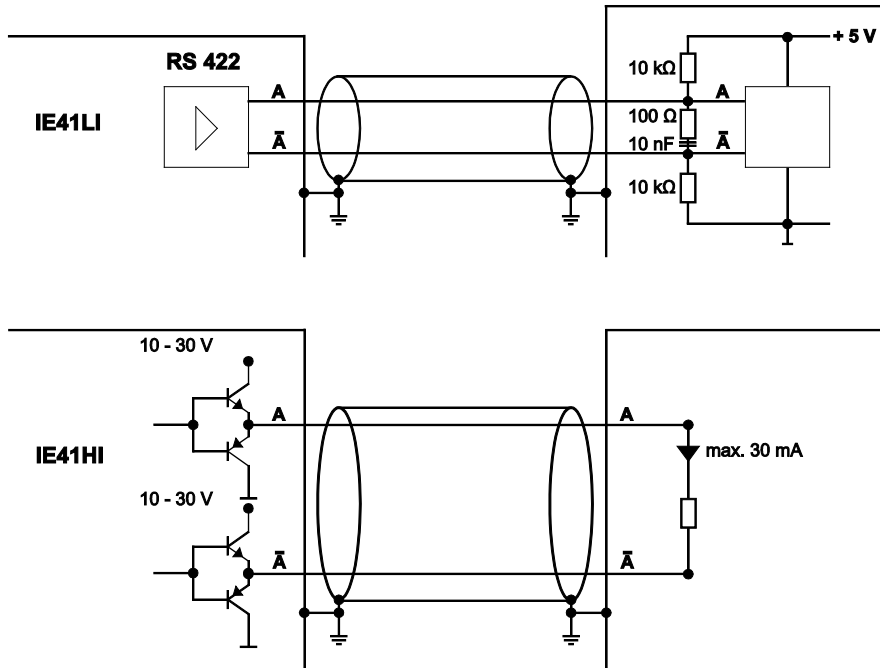

Output signals

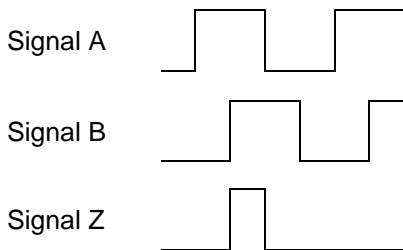

Accessories

Connector cable M12, 4 pin (angular coupling)

shielded connector

Suitable for 5-pin
sensor connectors

The 4-core screened cable is supplied with a mating 4-pin 90° M12 connector at one end and 4 wires at the other end. Available lengths are 2m, 5m and 10m. Wire: cross sectional area 0.34mm²
Cable diameter: 5.6 ±0.2 mm

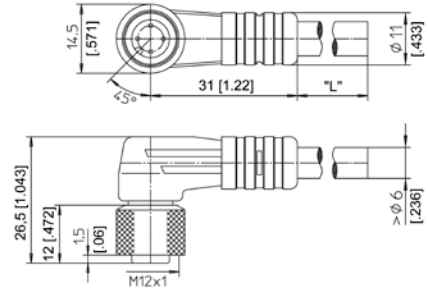

Order code

	KAB - xM - M12/4F/W - LITZE
IP69:	KAB - xM - M12/4F/W/69K - LITZE

xM = length in m

Connector cable M12, 4 pin (straight coupling)

shielded connector

Suitable for 5-pin
sensor connectors

The 4-core screened cable is supplied with a mating 4-pin M12 connector at one end and 4 wires at the other end. Available lengths are 2m, 5m and 10m. Wire: cross sectional area 0.34mm²
Cable diameter: 5.6 ±0.2 mm

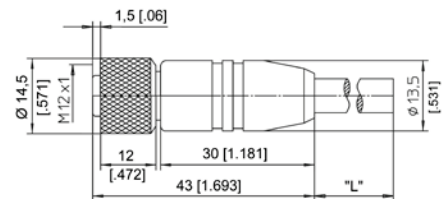

Order code

	KAB - xM - M12/4F/G - LITZE
IP69:	KAB - xM - M12/4F/G/69K - LITZE

xM = length in m

Signal wiring	Plug connection / cable color			
	1	2	3	4
M12, 4 pin	brown	white	blue	black

Applicable for cable carriers

Maximum movement speed	3 m/s
Maximum acceleration	5 m/s ²
Minimum bending radius	10 x cable diameter

**Connector cable M12, 5 pin
(angular coupling)**

shielded connector

The 5-core screened cable is supplied with a mating 5-pin 90° M12 connector at one end and 4 wires at the other end. Available lengths are 2m, 5m and 10m.
Wire: cross sectional area 0.34mm²
Cable diameter: 5.6 ±0.2mm

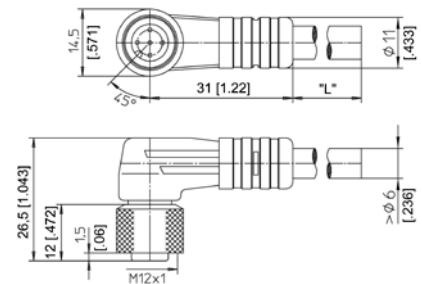

Order code

	KAB - xM - M12/5F/W - LITZE
IP69:	KAB - xM - M12/5F/W/69K - LITZE

xM = length in m

**Connector cable M12, 5 pin
(straight coupling)**

shielded connector

The 5-core screened cable is supplied with a mating 5-pin M12 connector at one end and 4 wires at the other end. Available lengths are 2m, 5m and 10m.
Wire: cross sectional area 0.34mm²
Cable diameter: 5.6 ±0.2mm

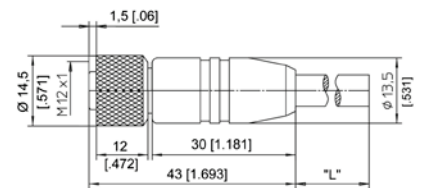

Order code

	KAB - xM - M12/5F/G - LITZE
IP69:	KAB - xM - M12/5F/G/69K - LITZE

xM = length in m

Signal wiring M12, 5 pin	Plug connection / Cable color				
	1	2	3	4	5
	brown	white	blue	black	grey

Applicable for cable carriers

Maximum movement speed	3 m/s
Maximum acceleration	5 m/s ²
Minimum bending radius	10 x cable diameter

**Connector cable M12, 8 pin
(angular coupling)**

shielded connector

The 8-lead shielded cable is supplied with a mating 8-pin 90° M12 connector at one end and 8 wires at the other end. Available lengths are 2m, 5m and 10m.

Wire: cross sectional area 0.25mm²
Cable diameter: 6.3 ±0.2mm

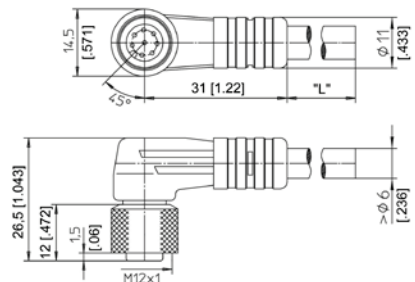

Order code

	KAB - xM - M12/8F/W - LITZE
IP69:	KAB - xM - M12/8F/W/69K - LITZE

xM = length in m

**Connector cable M12, 8 pin
(straight coupling)**

shielded connector

The 8-lead shielded cable is supplied with a mating 8-pin M12 connector at one end and 8 wires at the other end. Available lengths are 2m, 5m and 10m.

Wire: cross sectional area 0.25mm²
Cable diameter: 6.3 ±0.2mm

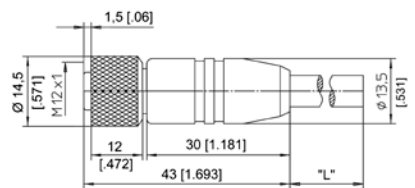

Order code

	KAB - xM - M12/8F/G - LITZE
IP69:	KAB - xM - M12/8F/G/69K - LITZE

xM = length in m

Signal wiring M12, 8 pin	Plug connection / cable color							
	1	2	3	4	5	6	7	8
	white	brown	green	yellow	grey	pink	blue	red

Applicable for cable carriers

Maximum movement speed	3 m/s
Maximum acceleration	5 m/s ²
Minimum bending radius	10 x cable diameter

Connector/bus cable - M12, 5 pin CAN-Bus

The 5-lead shielded cable is supplied with a female 5 pin M12 connector at one end and a male 5 pin M12 connector at the other end.

Available lengths are 0.3 m, 2 m, 5 and 10 m.

Cable diameter: 6.7 ±0.2 mm

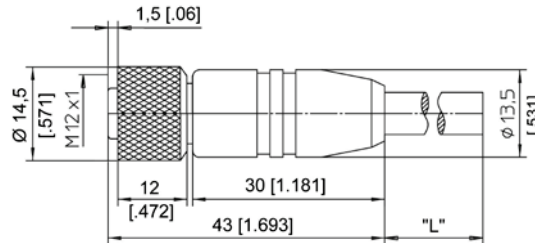

Order code:

KAB - xM - M12/5F/G - M12/5M/G - CAN

IP69: **KAB - xM - M12/5F/G/69K - M12/5M/G/69K - CAN**

xM = length in m

T-piece for bus cable M12, 5 pin CAN-Bus

Order code:

KAB - TCONN - M12/5M - 2M12/5F - CAN



Terminating resistance M12, 5 pin CAN-Bus

Order code:

KAB - RTERM - M12/5M/G - CAN



Applicable for cable carriers

Maximum movement speed	3 m/s
Maximum acceleration	5 m/s ²
Minimum bending radius	10 x cable diameter

Plug-in connector M12, 8 pin (straight coupling)

Order code:

CONN-M12-8F-G

Cable diameter
max. 6 ... 8 mm

