

## S81 SERIES

**S81** distance sensor line offers the best solution for all the applications where cost reduction is requested, without compromising the detection or measurement performances. The class 2 Laser emission and the exclusive time of flight measurement of light technology assure extreme precision in the distance measurement, with range up to 4 meters. The high resolution is not a limit for the sensing speed, reaching 5 ms response time and 80 Hz switching frequency. Thanks to only two push-buttons for different distance threshold setting, the automatic sensor setting is very easy and accurate for the two independent NPN or PNP outputs. The sensor is available in two different versions: **S81-...Y** for distance measurement with an additional 0-10 V analogue output, or **S81-...M** as long distance background suppression proximity with an additional alarm output for received signal problems or dirty lens condition. Moreover the **S81-...Y** version offers the possibility to scale the 0-10V analogue output. This feature allows to set the minimum and maximum values of the operating distance and link the minimum and maximum voltage.



MEASUREMENT

## HIGHLIGHTS

- Proximity measurement up to 4m
- Easy setting via push-buttons
- 2 PNP or NPN digital outputs
- 0-10V analogue output or alarm output

## APPLICATIONS

Automatic warehouse



Automotive



Wood



Easy setting:  
the switching thresholds are defined separately for each channel, by means of the following procedure:

- Set the target object in front of the sensor at the expected distance
- In order to set the switching threshold for the output 1, press the button until the LED1 starts blinking
- In order to set the switching threshold for the output 2, press the button until the LED2 starts blinking



## DIMENSIONS

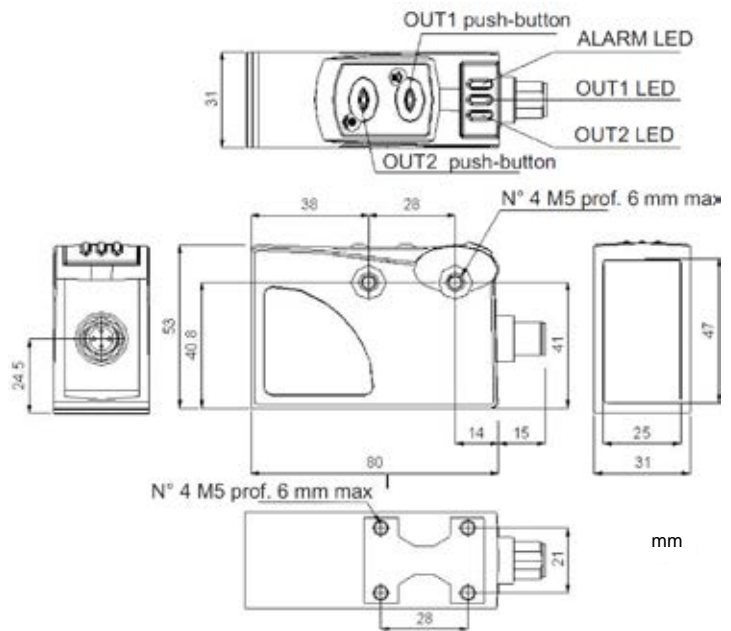

## INDICATORS AND SETTINGS

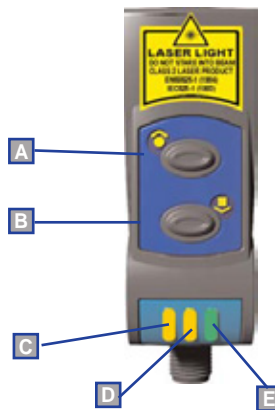

- A Output2 push-button
- B Output1 push-button
- C Output1 LED
- D Output2 LED
- E Power/Alarm LED

## ACCESSORIES

For **dedicated accessories** refer to the **ACCESSORIES** section of this catalogue.

Refer also to **Connectors** and **Fixing Brackets** and Supports of the **General Catalogue**.

## CONNECTIONS

S81-xx-x-Yxx-xxx models

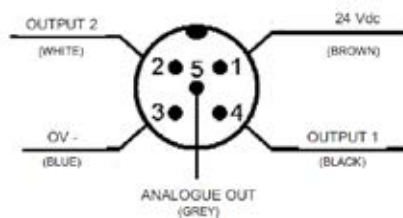

S81-xx-x-Mxx-xxx models

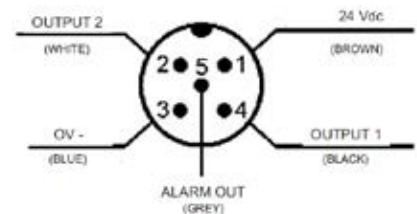

NOTE: the wire colours refer to the cables manufactured according to the European standard

## TECHNICAL DATA

Measurement range:	300 ... 4000 mm <sup>1</sup>
Linearity:	<1% f.s. (24 Vdc, 25 °C, with white 90% target)
Repeatability:	+/- 4 mm
Temperature drift:	< 1 mm/°C
Hysteresis:	20 mm
Power supply:	24 Vdc +/- 20%, limit values
Ripple:	2 Vpp max.
Consumption:	120 mA max (100 mA at 24V)
Light emission:	red Laser 665 nm, class 2
Spot dimension:	Ø3.5 mm at 0.3 m Ø7 mm at 4 m
Setting:	OUT2  , OUT1
Indicators:	yellow OUTPUT 1 LED yellow OUTPUT 2 LED green POWER / READY LED
Output type:	2 PNP or NPN outputs 1 PNP or NPN alarm output (only S81...M) 1 analogue 0-10 V output (only S81...Y)
Output current:	100 mA max.
Response time:	5 ms
Switching frequency:	80 Hz
Connections:	5-pole M12 connector
Electrical protection:	class 2
Mechanical protection:	IP67
Protection devices:	A, B <sup>2</sup>
Housing material:	ABS
Lens material:	PMMA
Weight:	92 g max.
Operating temperature:	-10 ... 50 °C
Storage temperature:	-20 ... 70 °C
Reference standard:	EN 60947-5-2, EN 60825-11

## TECHNICAL NOTES

- <sup>1</sup>On target 90% white to 18% grey
- <sup>2</sup>A - reverse polarity protection
- B - overload and short-circuit protection

## SELECTION TABLE

Model	Analogue output 0-10V	Scalable 0-10V Analogue output	Alarm output Switching outputs	2 NPN	2 PNP Switching outputs
S81-PL-5-M03-NNC			•	•	
S81-PL-5-M03-PPC			•		•
S81-PL-5-Y03-NNV	•			•	
S81-PL-5-Y03-PPV	•				•
S81-PL-5-Y03-PPVK		•	•		



## DETECTION DIAGRAMS

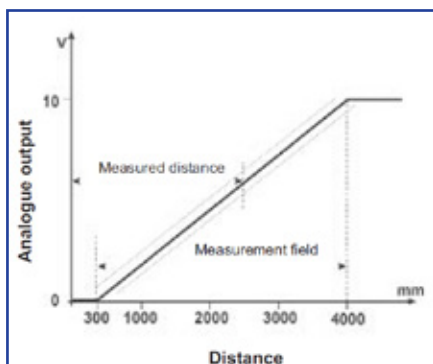

Analogue output

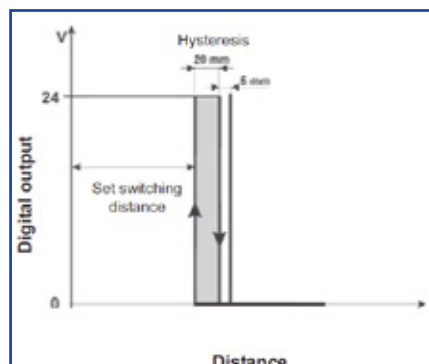

Digital outputs

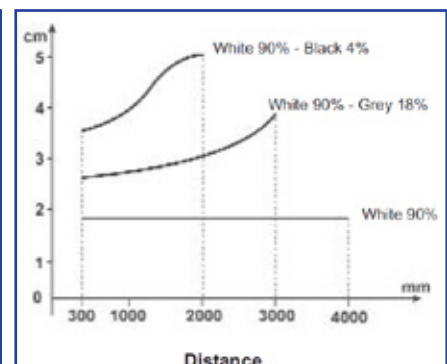

White/Black difference

## MODEL SELECTION AND ORDER INFORMATION

MODEL	MAX. DISTANCE	ANALOGUE OUT	alarm output	SWITCHING OUTPUT	N° ORDER
S81-PL-5-M03-NNC	4 m	no	yes	2 NPN	951551100
S81-PL-5-M03-PPC	4 m	no	yes	2 PNP	951551110
S81-PL-5-Y03-NNV	4 m	yes	no	2 NPN	951551120
S81-PL-5-Y03-PPV	4 m	yes	no	2 PNP	951551030
S81-PL-5-Y03-PPVK	4 m	yes	no	2 PNP	951551040

## ACCESSORY SELECTION AND ORDER INFORMATION

MODEL	DESCRIPTION	N° ORDER
CS-A1-06-B-03	M12 8-pole conn. with 3 m unshielded cable	95ACC2230
CS-A1-06-B-05	M12 8-pole conn. with 5 m unshielded cable	95ACC2240
CS-A1-06-B-10	M12 8-pole conn. with 10 m unshielded cable	95ACC2250



The company endeavours to continuously improve and renew its products; for this reason the technical data and contents of this catalogue may undergo variations without prior notice. For correct installation and use, the company can guarantee only the data indicated in the instruction manual supplied with the products.