

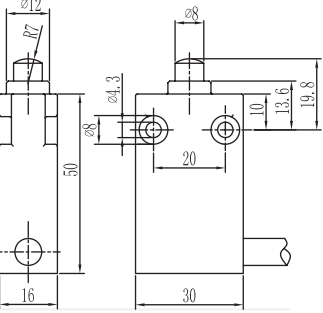









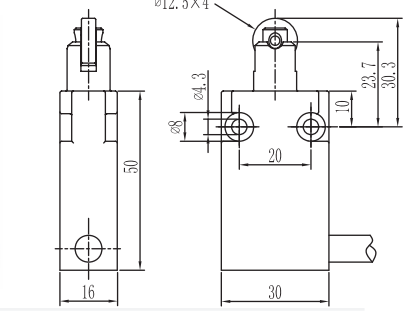

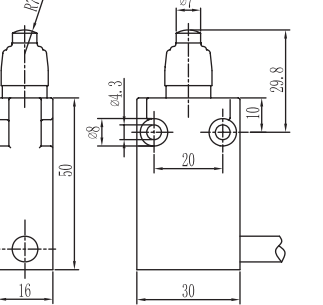

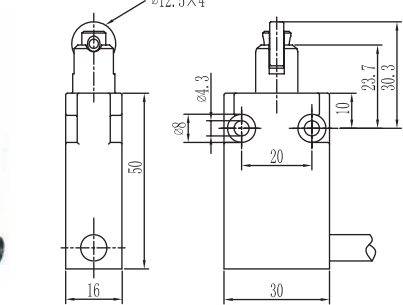
COMPACT LIMIT SWITCHES (IP67 Water-Proof)

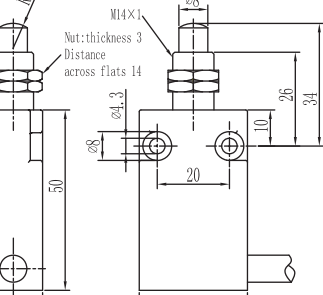
			
<p>Order Code</p> <p>SN3101-SP SP ↻ snap action 1NO+1NC</p> <p>SN3101-SL SL ↻ slow action 1NO+1NC BBM</p>	<p>Contact block</p>	<p>Order Code</p> <p>SN3112-SP SP ↻ snap action 1NO+1NC</p> <p>SN3112-SL SL ↻ slow action 1NO+1NC BBM</p>	<p>Contact block</p>
			
<p>Order Code</p> <p>SN3111-SP SP ↻ snap action 1NO+1NC</p> <p>SN3111-SL SL ↻ slow action 1NO+1NC BBM</p>	<p>Contact block</p>	<p>Order Code</p> <p>SN3122-SP SP ↻ snap action 1NO+1NC</p> <p>SN3122-SL SL ↻ slow action 1NO+1NC BBM</p>	<p>Contact block</p>
			
<p>Order Code</p> <p>SN3121-SP SP ↻ snap action 1NO+1NC</p> <p>SN3121-SL SL ↻ slow action 1NO+1NC BBM</p>	<p>Contact block</p>	<p>Order Code</p> <p>SN3102-SP SP ↻ snap action 1NO+1NC</p> <p>SN3102-SL SL ↻ slow action 1NO+1NC BBM</p>	<p>Contact block</p>
			
<p>Order Code</p> <p>SN3131-SP SP ↻ snap action 1NO+1NC</p> <p>SN3131-SL SL ↻ slow action 1NO+1NC BBM</p>	<p>Contact block</p>	<p>Order Code</p> <p>SN3103-SP SP ↻ snap action 1NO+1NC</p> <p>SN3103-SL SL ↻ slow action 1NO+1NC BBM</p>	<p>Contact block</p>

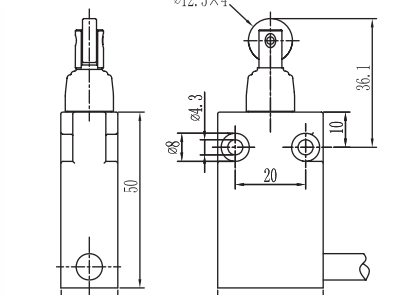
COMPACT LIMIT SWITCHES (IP67 Water-Proof)

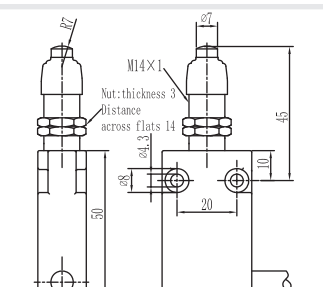
<p>Order Code Contact block</p> <p>SN3132-SP SP snap action 1NO+1NC</p> <p>SN3132-SL SL slow action 1NO+1NC BBM</p>	<p>Order Code Contact block</p> <p>SN3142-SP SP snap action 1NO+1NC</p> <p>SN3142-SL SL slow action 1NO+1NC BBM</p>
<p>Order Code Contact block</p> <p>SN3104-SP SP snap action 1NO+1NC</p> <p>SN3104-SL SL slow action 1NO+1NC BBM</p>	<p>Order Code Contact block</p> <p>SN3104-SP-S SP snap action 1NO+1NC</p> <p>SN3104-SL-S SL slow action 1NO+1NC BBM</p>
<p>Order Code Contact block</p> <p>SN3107-SP SP snap action 1NO+1NC</p> <p>SN3107-SL SL slow action 1NO+1NC BBM</p>	<p>Order Code Contact block</p> <p>SN3108-SP SP snap action 1NO+1NC</p> <p>SN3108-SL SL slow action 1NO+1NC BBM</p>
<p>Order Code Contact block</p> <p>SN3105-SP SP snap action 1NO+1NC</p> <p>SN3105-SL SL slow action 1NO+1NC BBM</p>	<p>Order Code Contact block</p> <p>SN3166-SP SP snap action 1NO+1NC</p> <p>SN3166-SL SL slow action 1NO+1NC BBM</p>

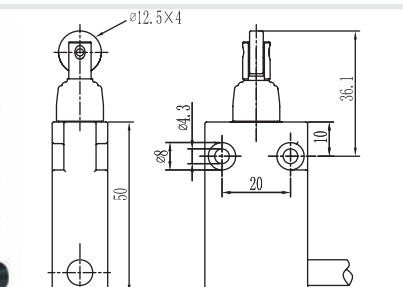
COMPACT LIMIT SWITCHES (IP67 Water-Proof)

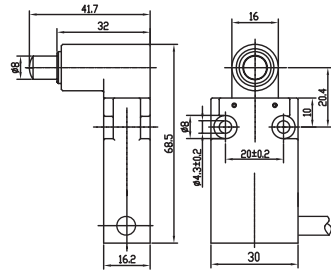

Order Code	Contact block			
SN3101-SP-H	SP	↻	snap action	1NO+1NC
SN3101-SL-H	SL	↻	slow action	1NO+1NC BBM

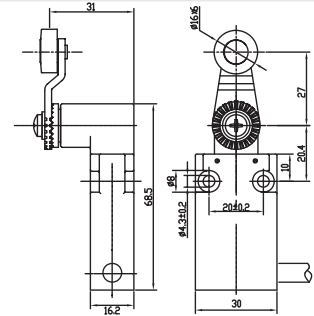

Order Code	Contact block			
SN3104-SP-H	SP	↻	snap action	1NO+1NC
SN3104-SL-H	SL	↻	slow action	1NO+1NC BBM

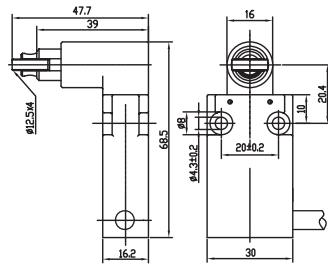

Order Code	Contact block			
SN3112-SP-H	SP	↻	snap action	1NO+1NC
SN3112-SL-H	SL	↻	slow action	1NO+1NC BBM

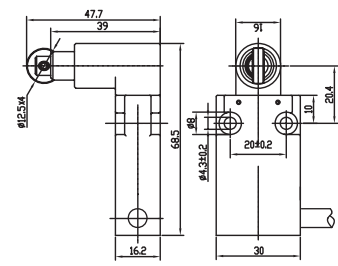

Order Code	Contact block			
SN3122-SP-H	SP	↻	snap action	1NO+1NC
SN3122-SL-H	SL	↻	slow action	1NO+1NC BBM

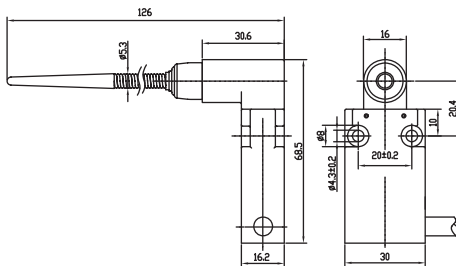

Order Code	Contact block			
SN3166-SP-H	SP	↻	snap action	1NO+1NC
SN3166-SL-H	SL	↻	slow action	1NO+1NC BBM

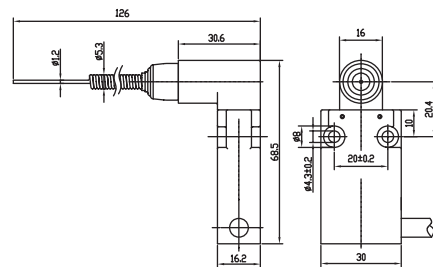

Order Code	Contact block			
SN3169-SP-H	SP	↻	snap action	1NO+1NC
SN3169-SL-H	SL	↻	slow action	1NO+1NC BBM

COMPACT LIMIT SWITCHES (IP67 Water-Proof)

Basic Body dimension:

Suffix: -A (cable side exit)

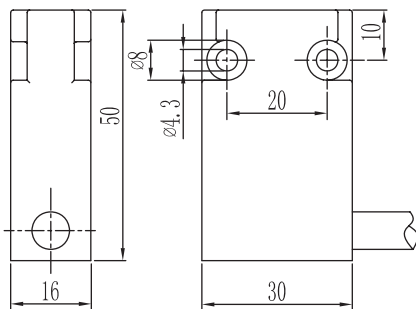

Suffix: -B (cable bottom exit)

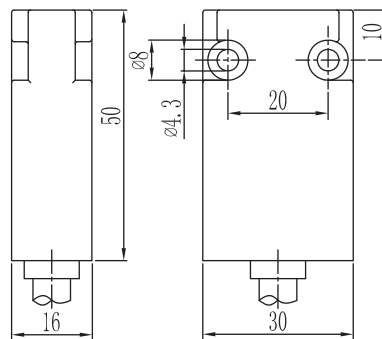

Suffix: -C (M12 quick connector side exit 4 pin)
Suffix: -E (M12 quick connector side exit 5 pin)

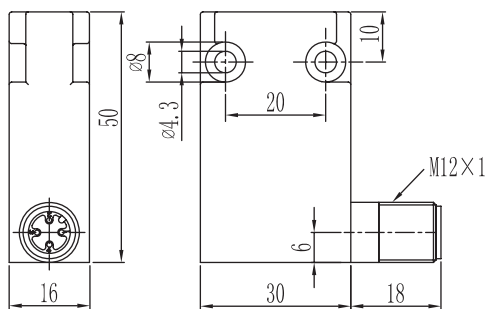

5 pin M12

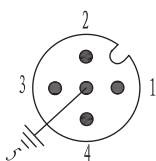

1-2=NC
 3-4=NO
 5=⊥

Suffix: -D (M12 Quick Connector bottom exit 4 pin)
Suffix: -F (M12 Quick Connector bottom exit 5 pin)

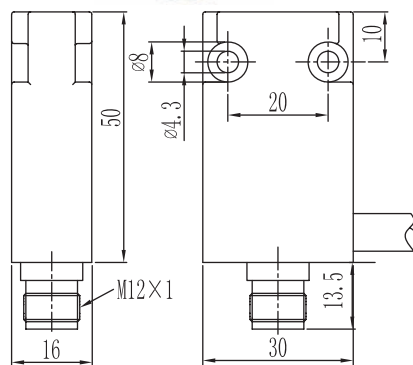

4 pin M12

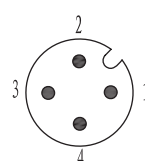

1-2=NC
 3-4=NO